

# Installation Instructions

## In-Channel Wind Deflectors

### Safety Precautions



- **WARNING** – Before driving, make sure your wind deflector is firmly attached to your vehicle.
- Avoid using automatic brush-style car washes.
- Avoid using any cleaning solvents.
- Regularly inspect all components for tightness.

### 2-Piece Kit Includes:

**NOTE:** Pictures below may differ from actual product.

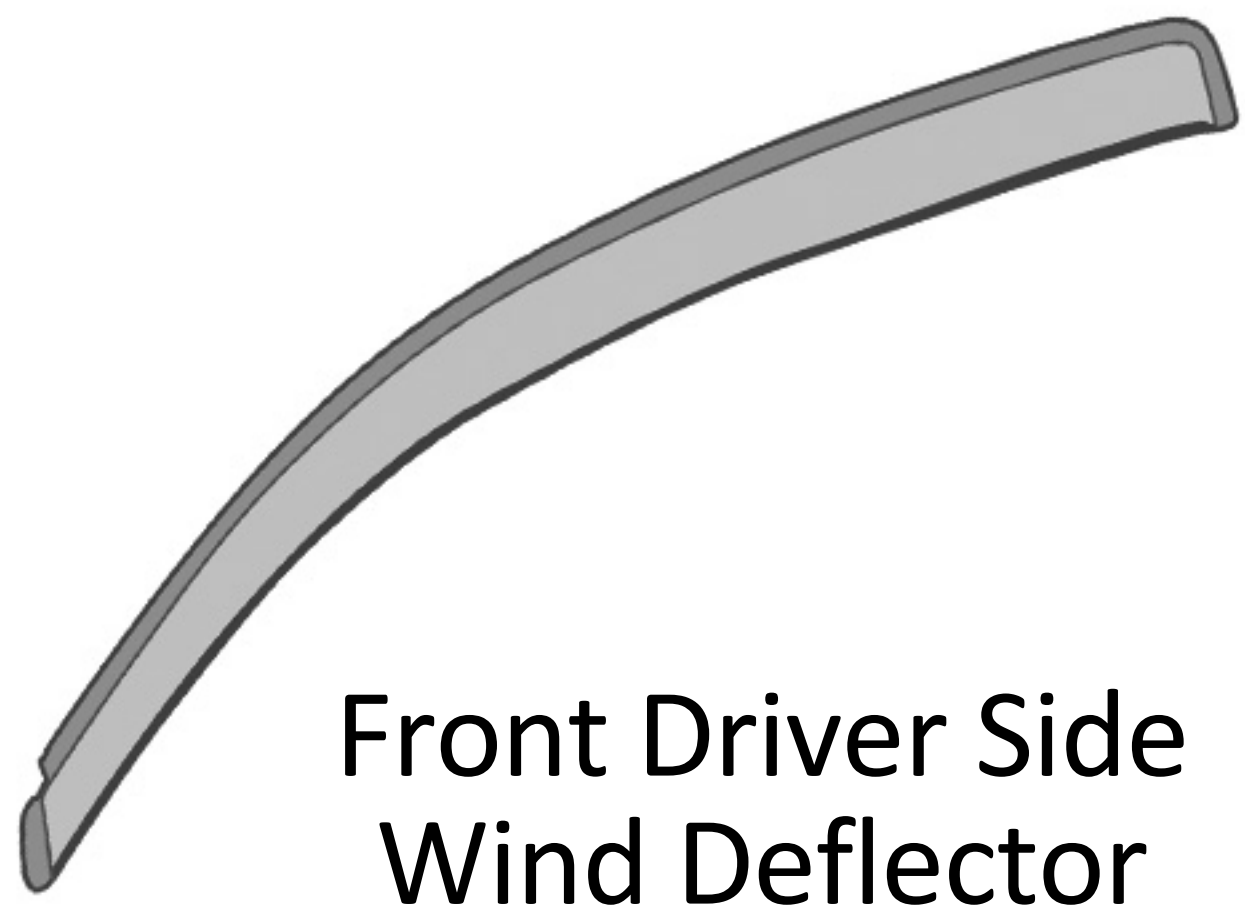

Front Driver Side  
Wind Deflector

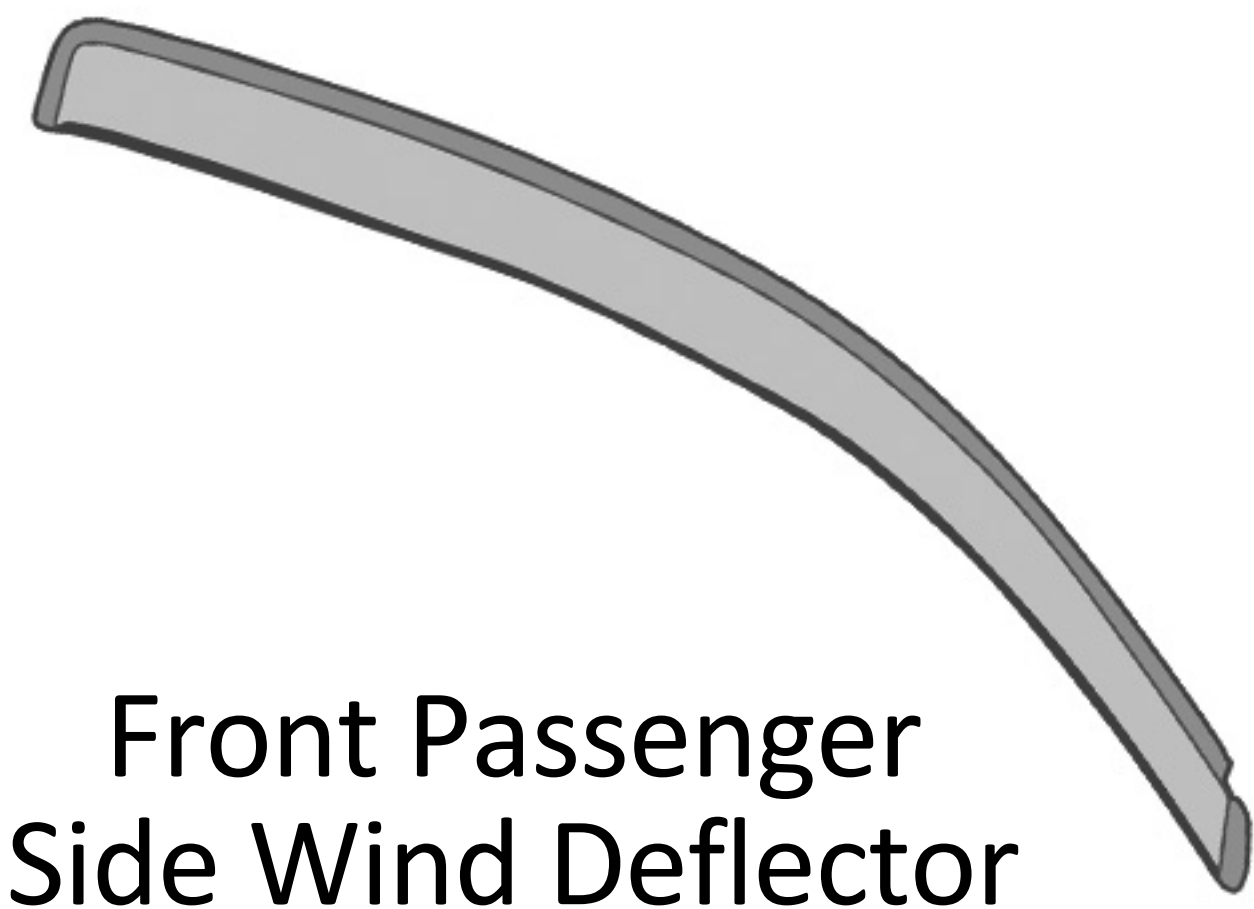

Front Passenger  
Side Wind Deflector

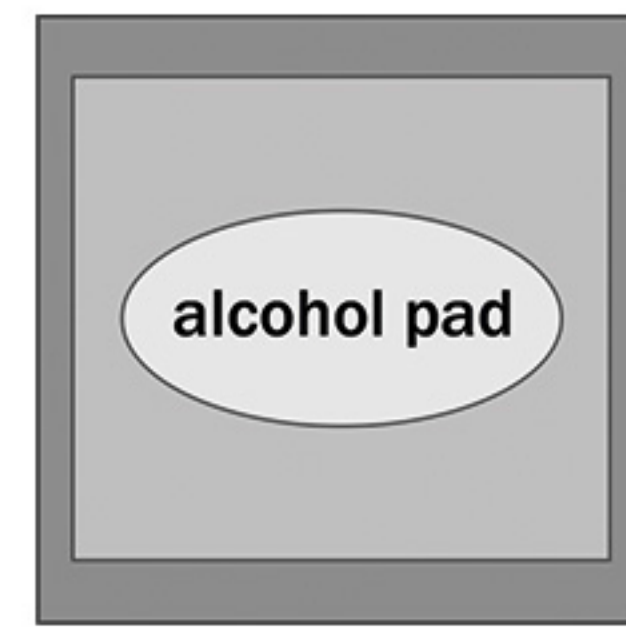

2 Alcohol  
Pads

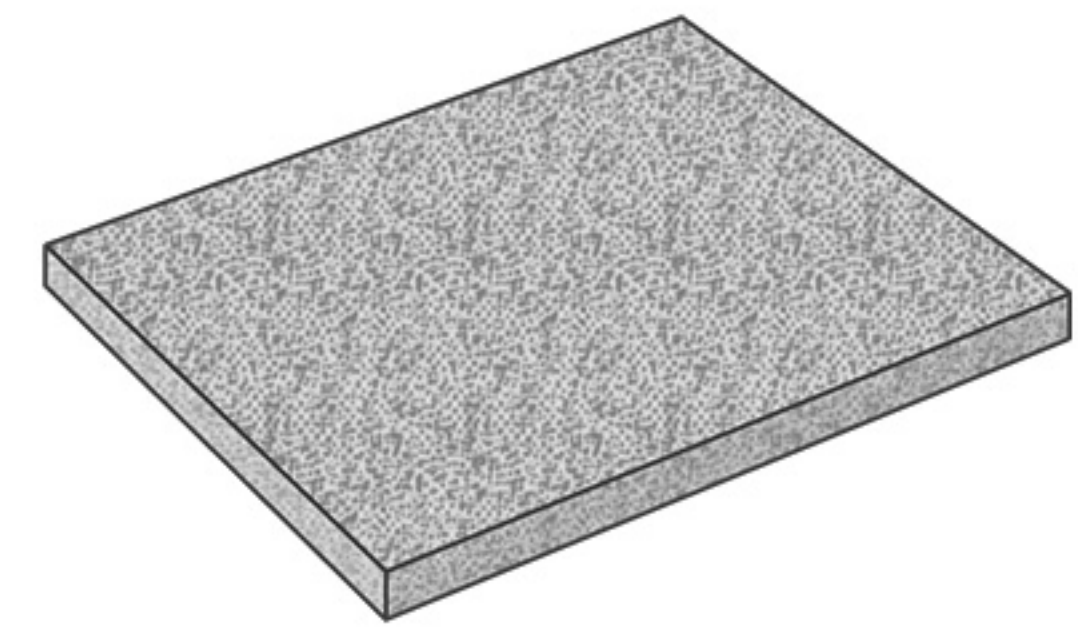

Scotch Brite Pad

### 4-Piece Kit Includes:

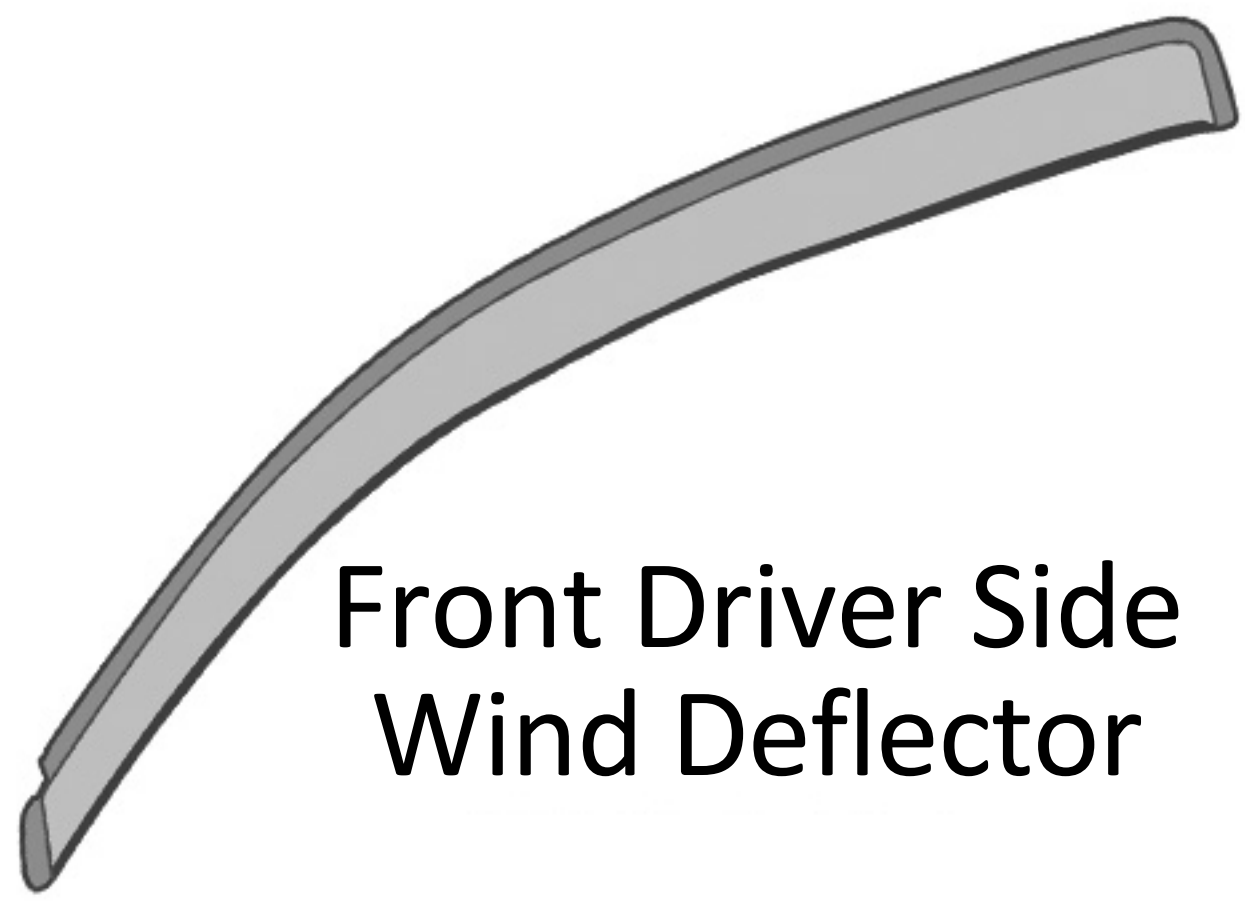

Front Driver Side  
Wind Deflector

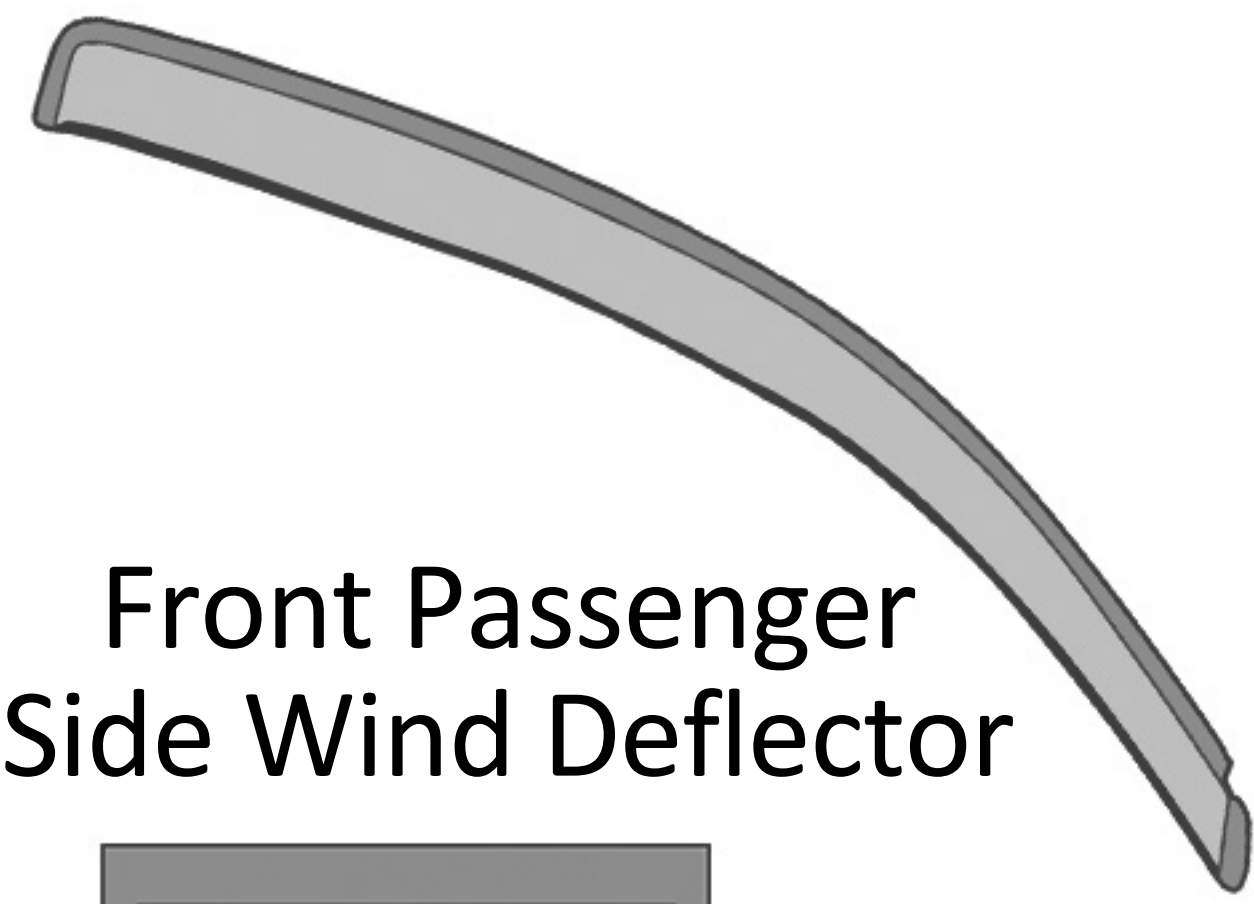

Front Passenger  
Side Wind Deflector

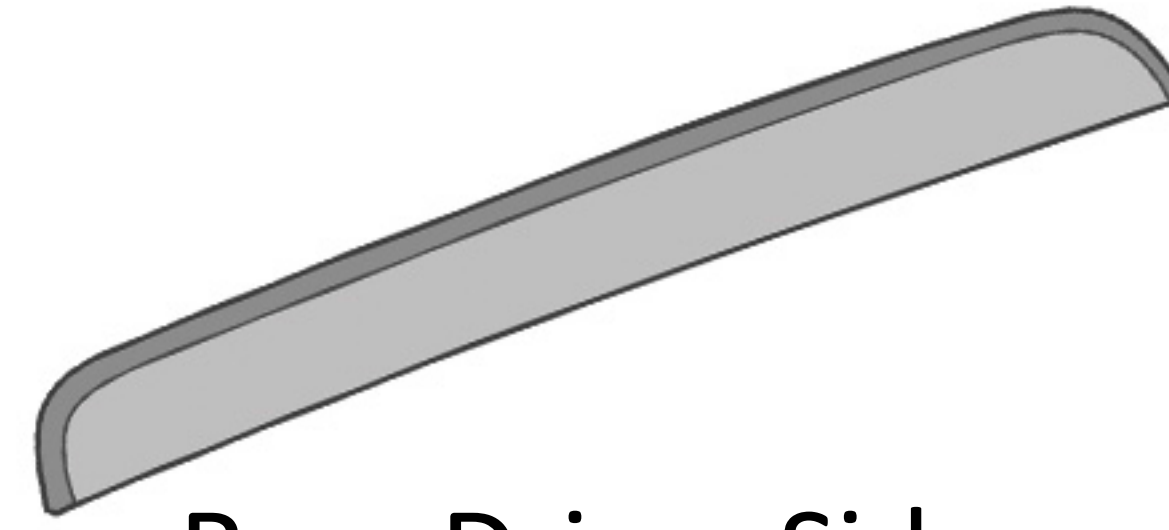

Rear Driver Side  
Wind Deflector

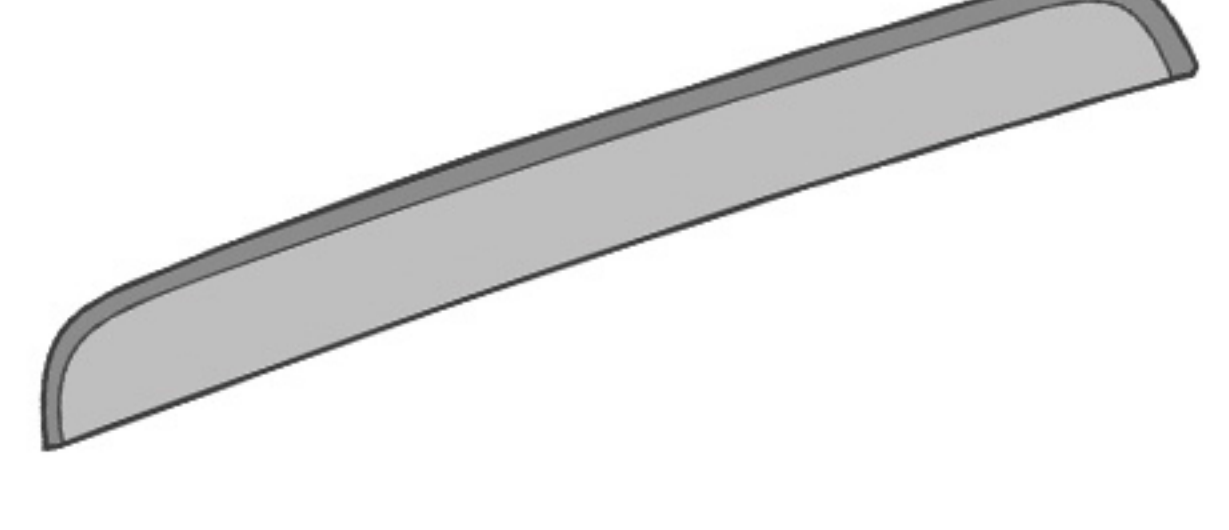

Rear Passenger  
Side Wind Deflector



4 Alcohol Pads

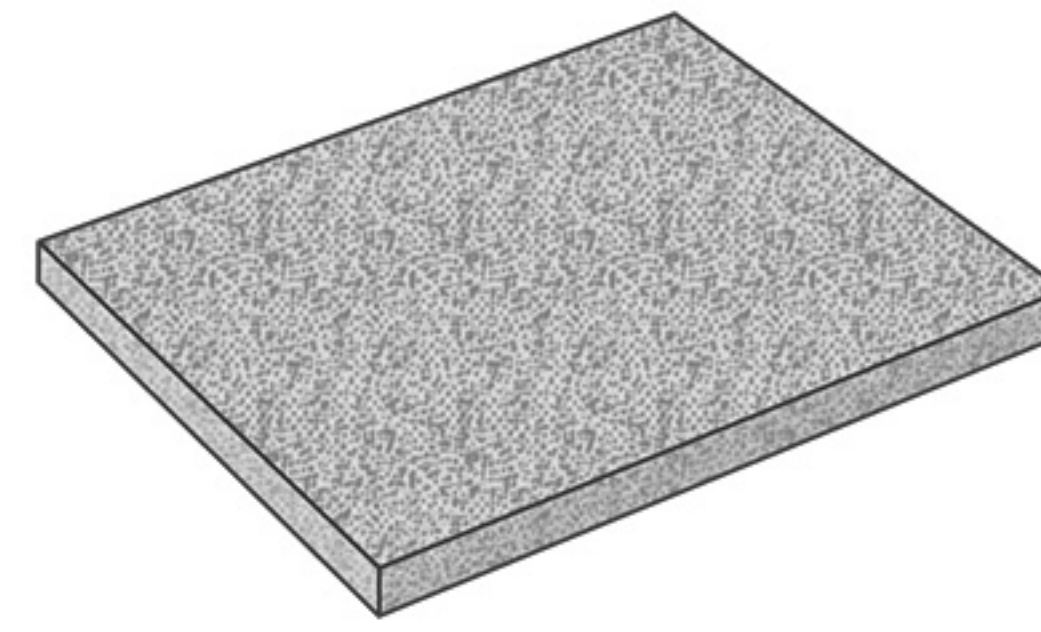

Scotch Brite Pad

### Necessary Tools



Car Wash Supplies

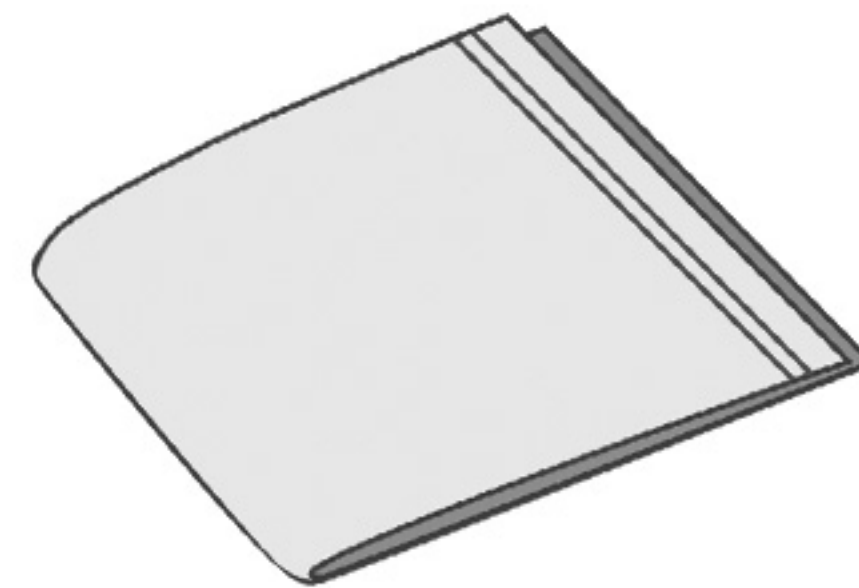

Clean Towel

### Installation / Painting Preparation

- ▽ u
  - ▽ "
  - ▽ u
  - ▽ y
- h

# Installation Procedure

**NOTE:** Pictures below may differ slightly from actual application.

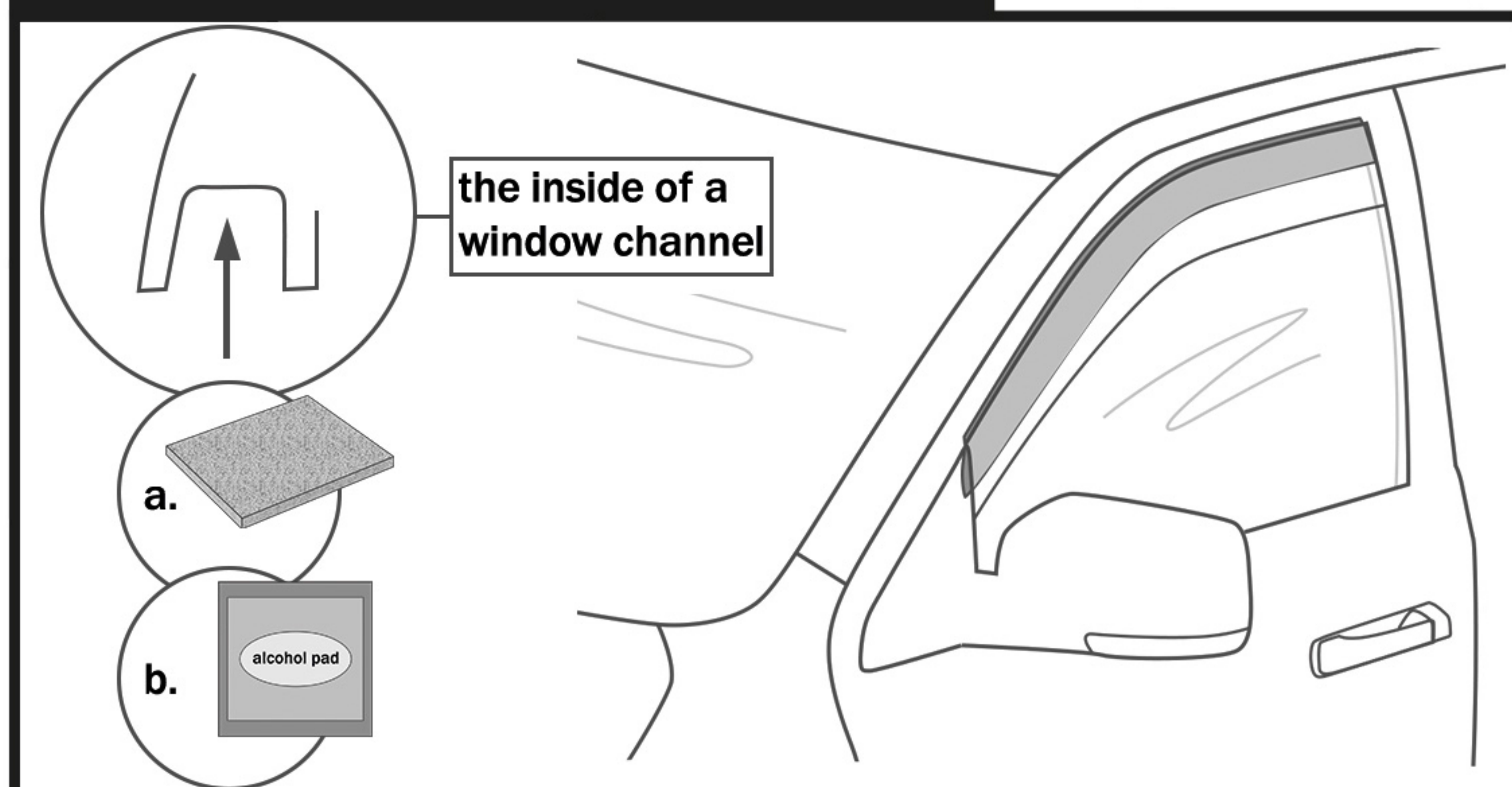

**1** Roll your window all the way down. Use Scotch Brite pad to scrub the inside of the window channel. Then wipe it with alcohol pad. **NOTE:** Wind deflectors install on the inside of the window channel.

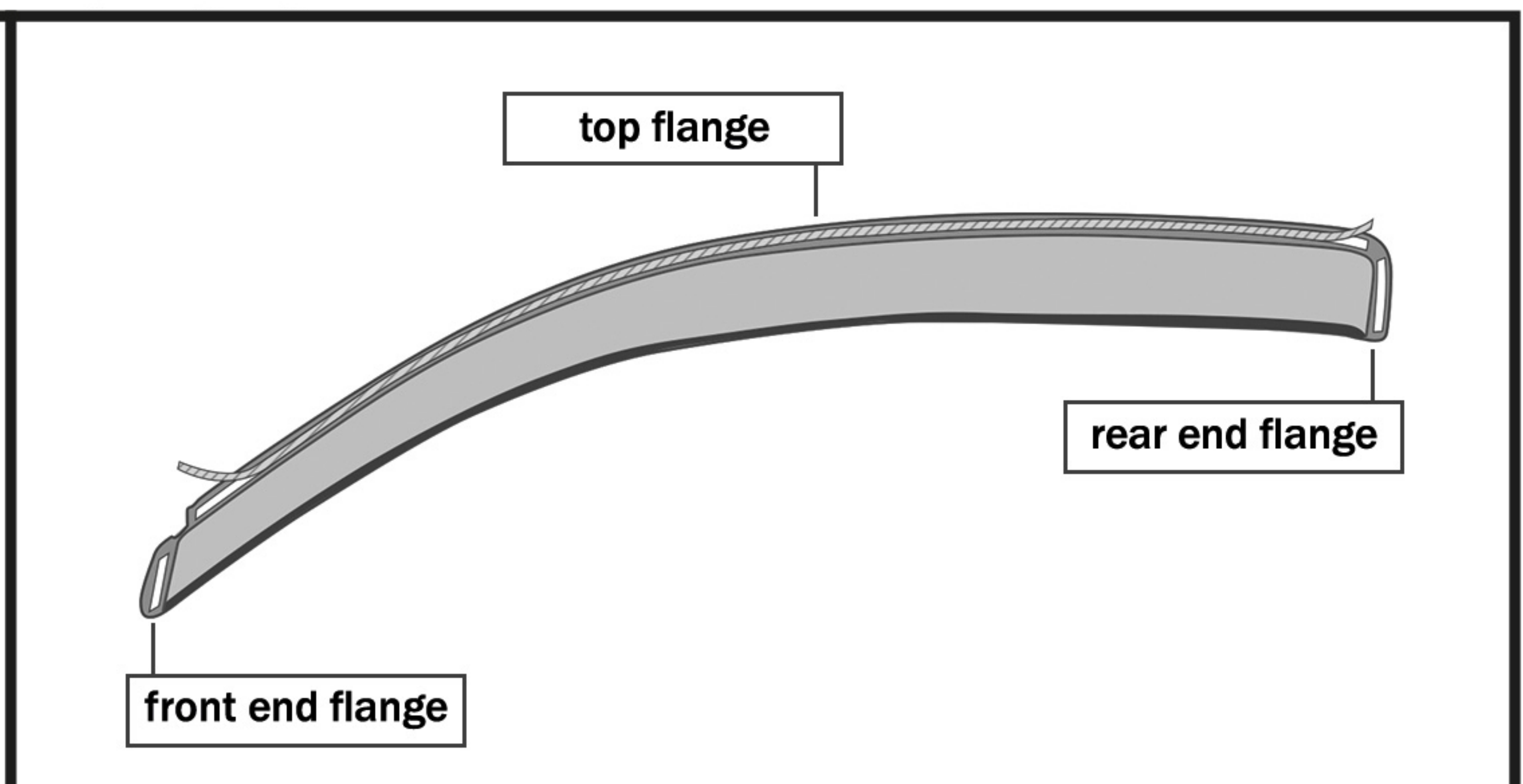

**2** Remove the adhesive tape backing from each end of the tape. Peel back 2" of the adhesive tape backing from the front and rear end flanges.

Make sure the front end of the wind deflector is between the mirror cap and rubber trim and doesn't slide inside the window channel. After that rotate the deflector up and slip the front and rear flanges into the window channel.

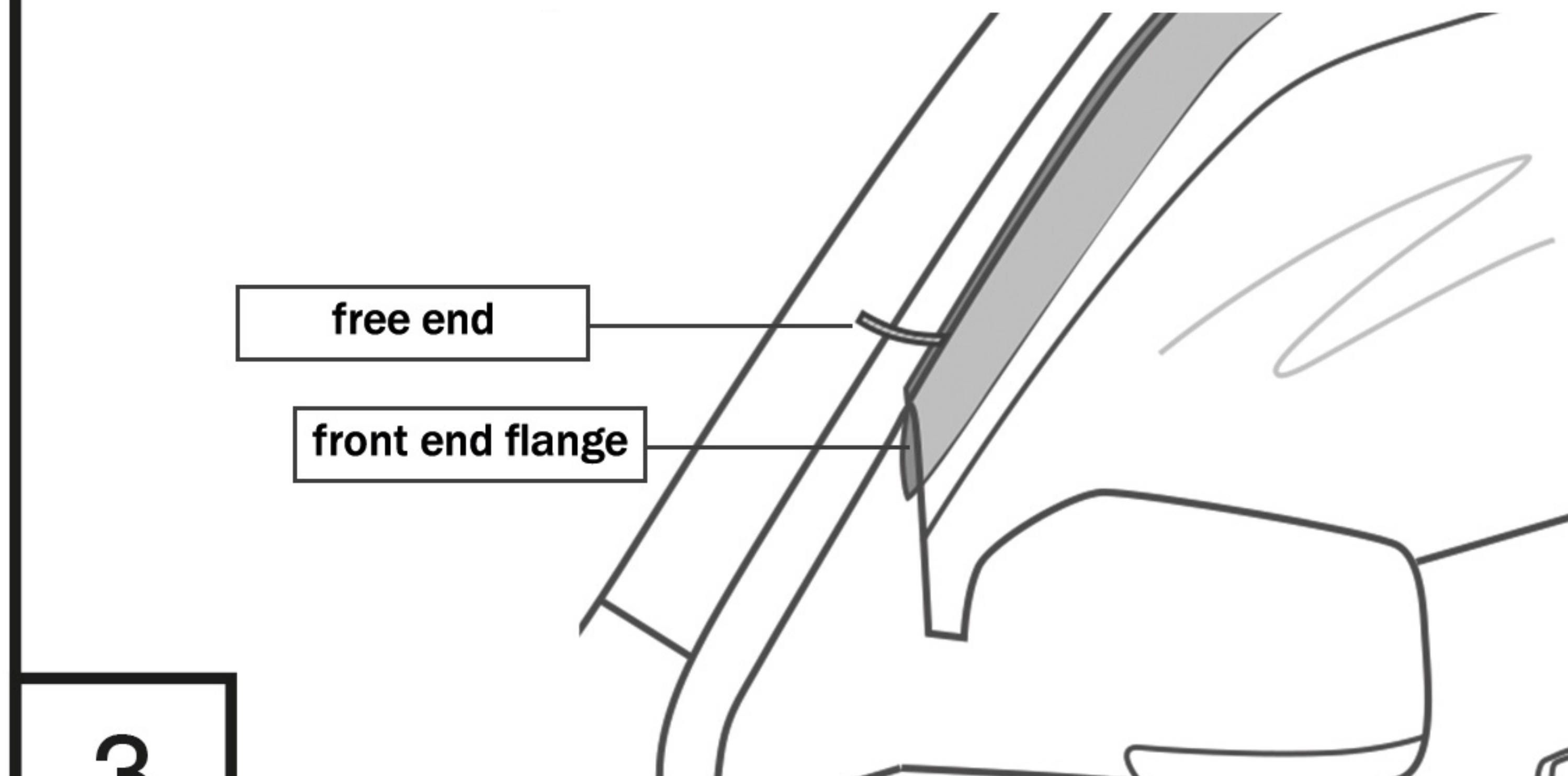

**3** **NOTE:** Proper placement is necessary to keep the window from cracking the flange.

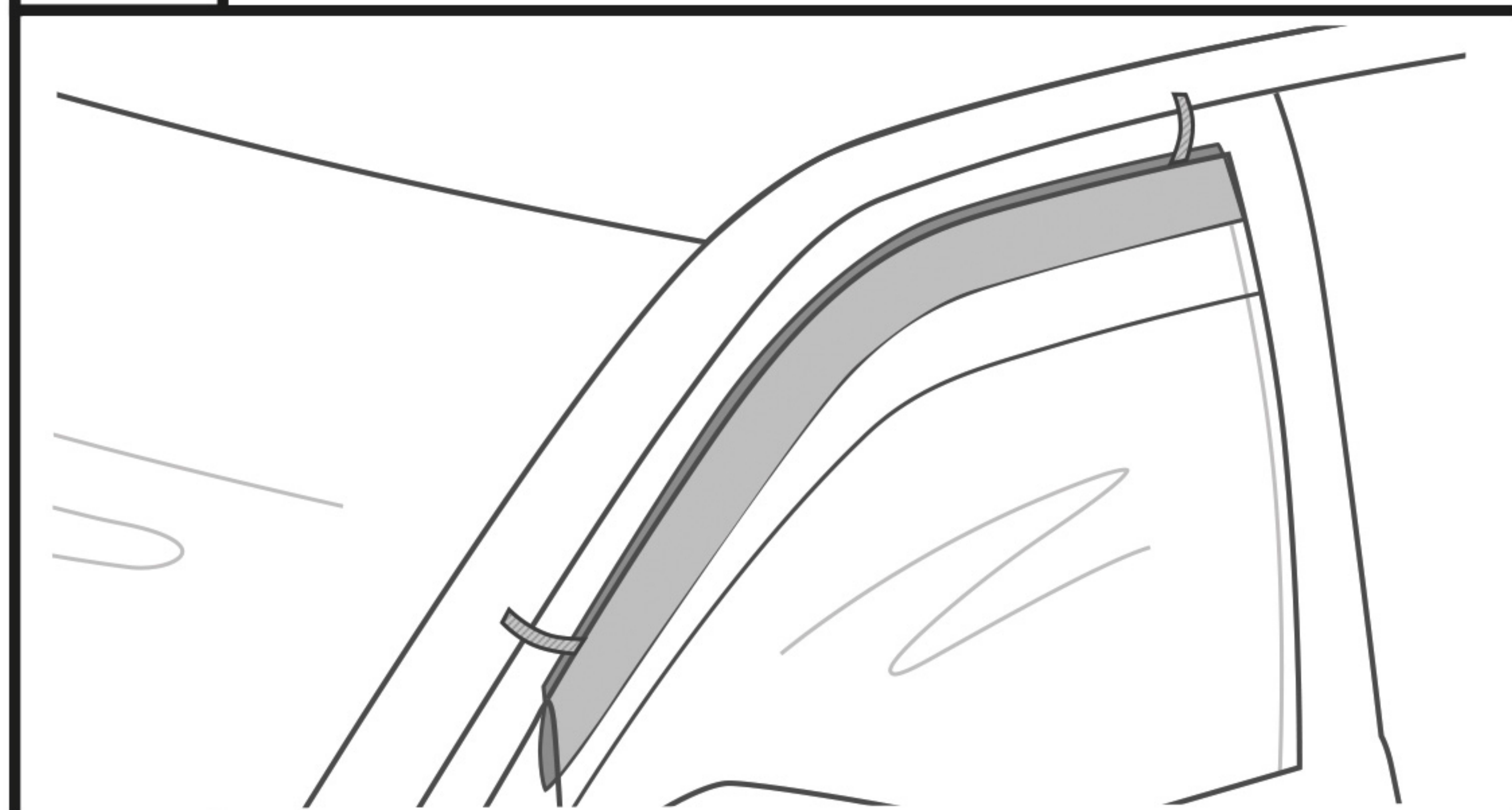

**4** Slide the exposed area of the tape in the window channel to verify the position.

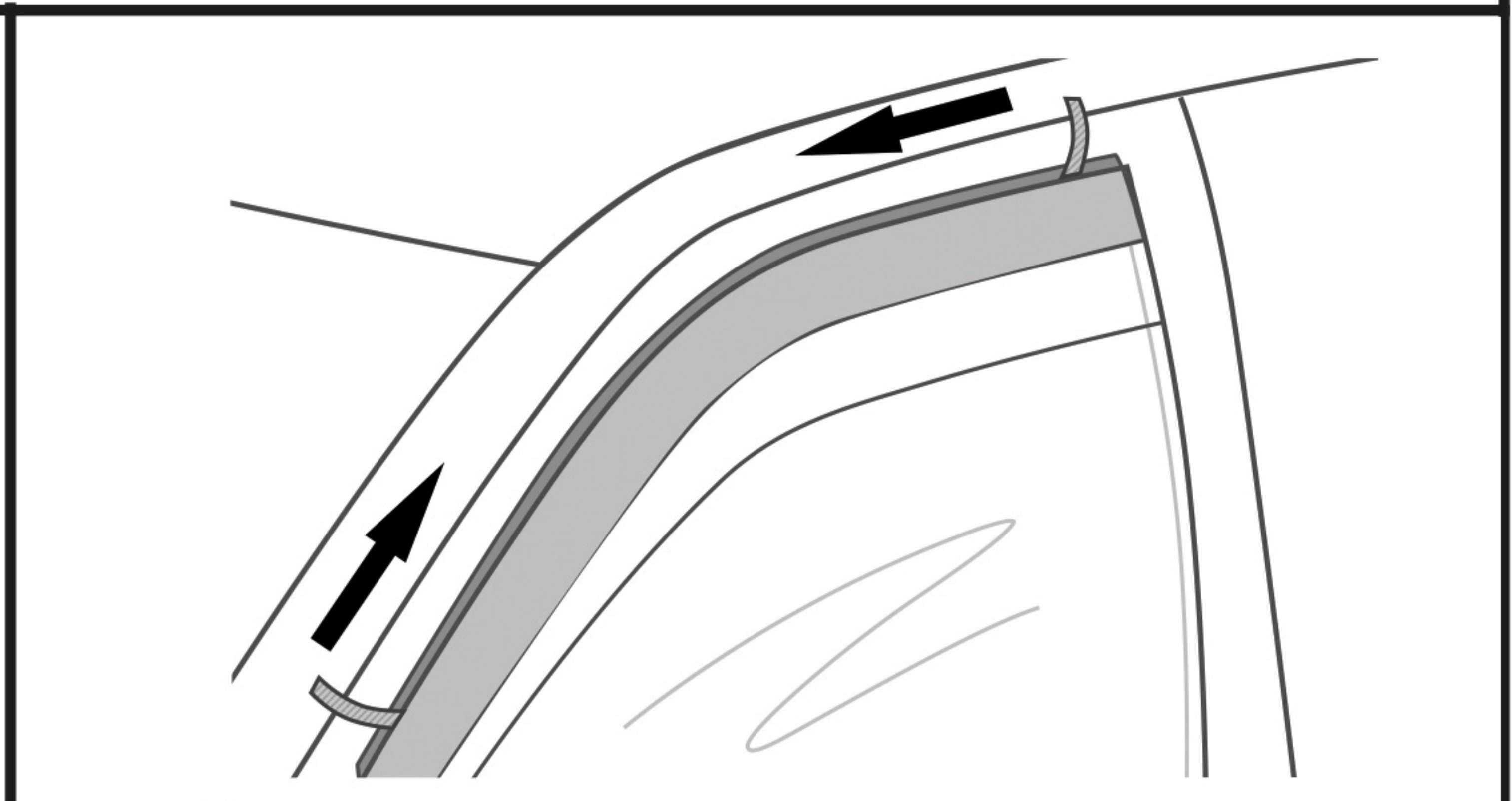

**5** Once the deflector is properly positioned, remove the remaining backing from the adhesive tape by pulling on free ends.

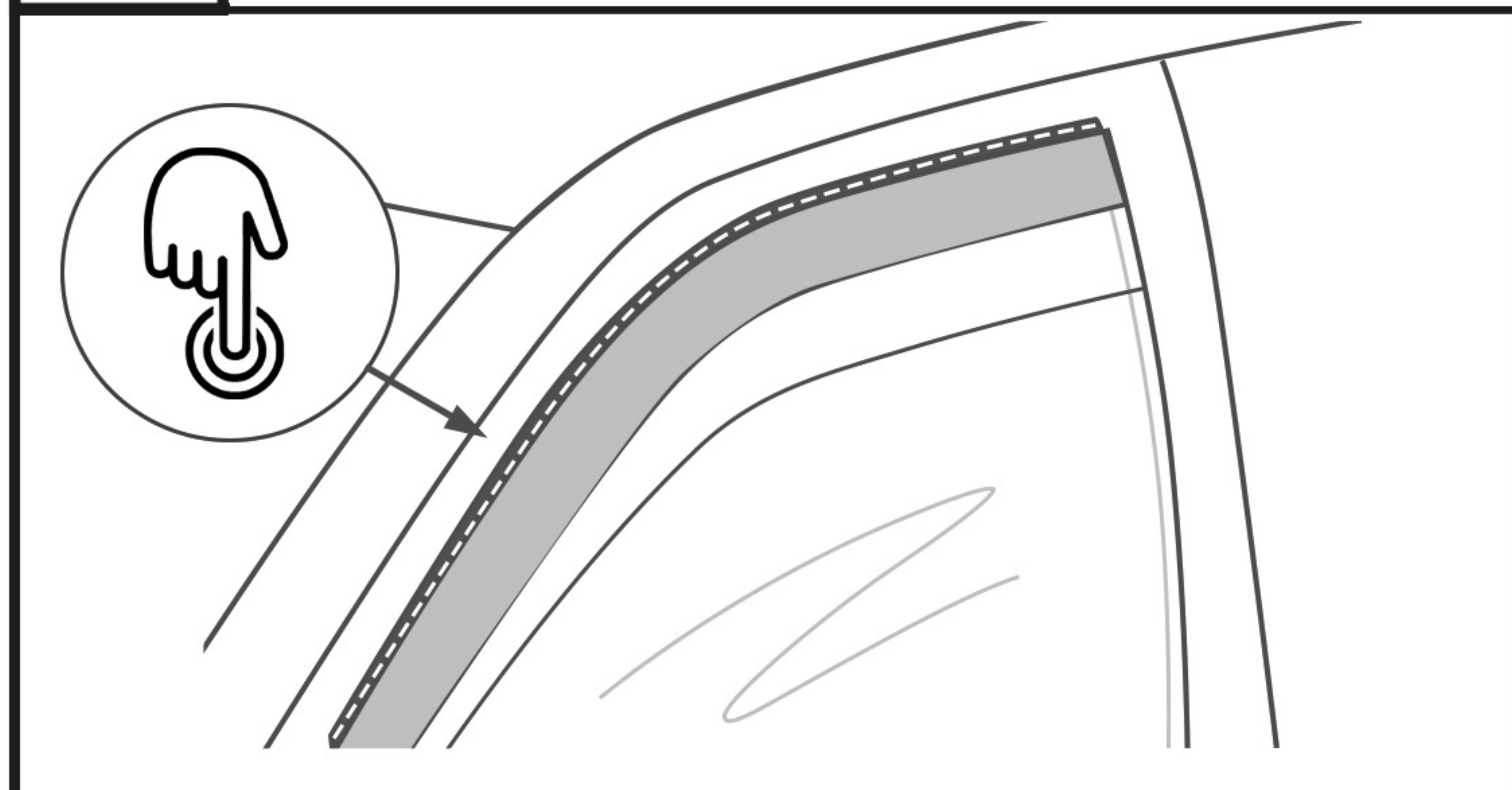

**6** Apply pressure with your fingertips along the flange edges and the entire length of the deflector to secure it in place.

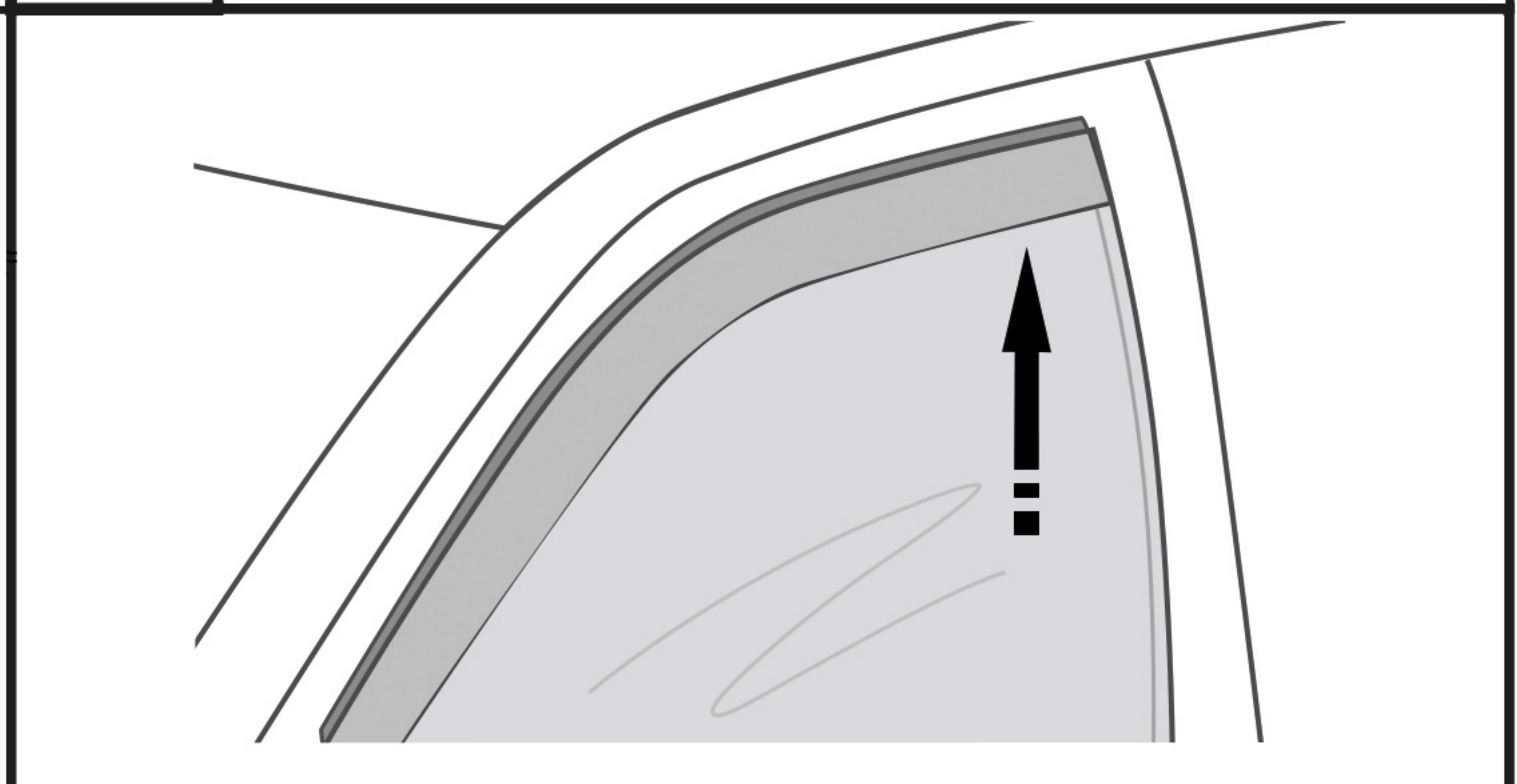

**7** Roll your window all the way up and leave it for at least 24 hours to ensure the adhesive is properly set.

## 4-Piece Kit

**NOTE:** Pictures below may differ slightly from actual application.

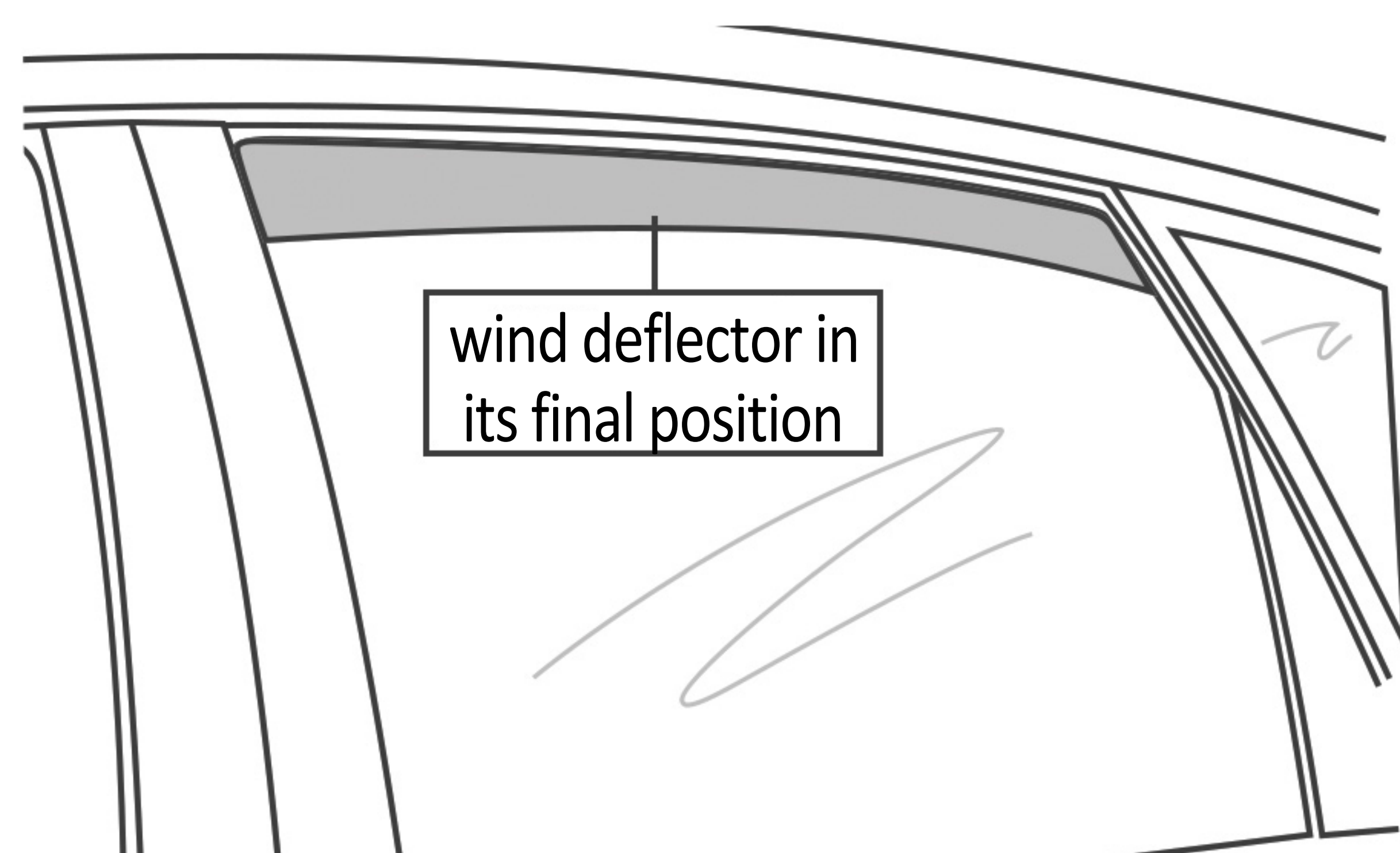

Repeat **Steps 1-8** for passenger side.

**8**

The driver side rear wind deflector installs following the same installation steps.

## Washing and Care

- Use only mild soap for cleaning. Wipe dry using a clean cloth.

## Congratulations!