

**EXTREME GRILLE GUARD
2009-2012 F150 (INCLUDES ECOBOOST)**

PARTS LIST:

1	Grille Guard	4	12-1.75mm x 150mm x 40mm Gr. 10.9 Hex Bolts
1	Driver/Left Front Frame Mounting Bracket	8	12-1.75mm x 40mm Gr. 10.9 Hex Bolts
1	Passenger/Right Front Frame Mounting Bracket	24	12mm x 32mm OD x 3mm Flat Washers
1	Driver/Left Outer Support Bracket	8	12mm Lock Washers
1	Passenger/Right Outer Support Bracket	8	12mm Hex Nuts
1	Driver/Left Inner Support Bracket	4	12mm Nylon Lock Nuts (for use on Support Brackets only)
1	Passenger/Right Inner Support Bracket		

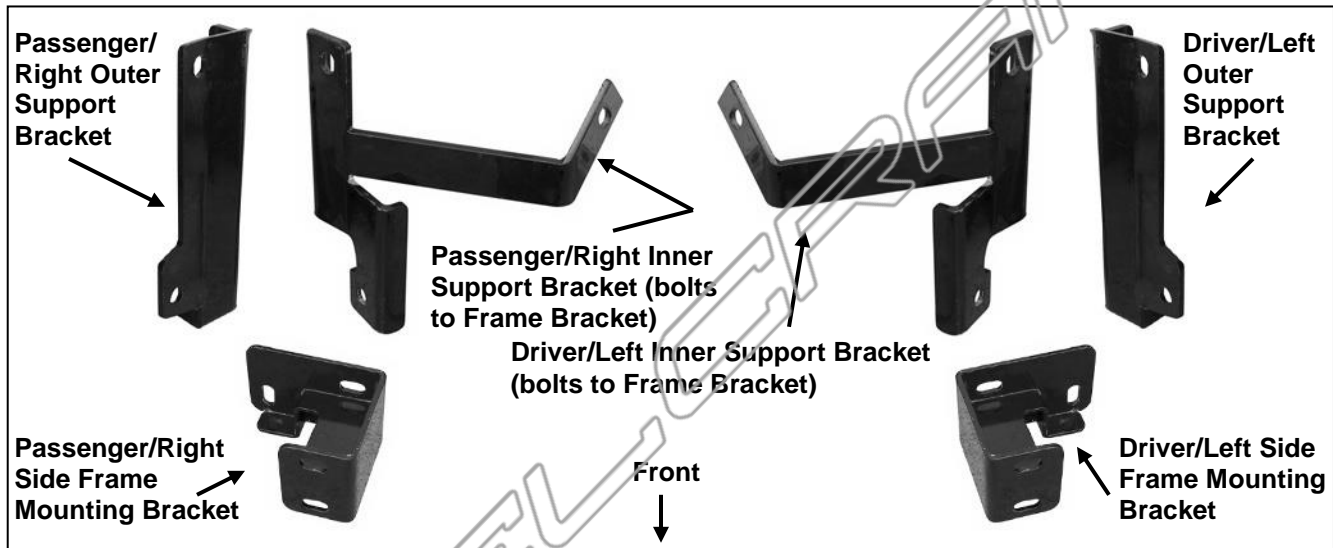

PROCEDURE:

REMOVE CONTENTS FROM BOX. VERIFY ALL PARTS ARE PRESENT. READ INSTRUCTIONS CAREFULLY BEFORE STARTING INSTALLATION. GRILLE GUARD IS VERY HEAVY AND ASSISTANCE IS HIGHLY RECOMMENDED TO AVOID POSSIBLE INJURY OR DAMAGE TO THE VEHICLE. CUTTING MAY BE REQUIRED.

2011-12 w/EcoBoost: It will be necessary to relocate the front license plate. If local/state law requires a front license plate, an aftermarket bracket kit must be purchased separately. Follow manufacturer's directions for installation. **IMPORTANT:** Do not block the air inlet in the front bumper on EcoBoost equipped vehicles!

- Remove the front license plate and plastic bracket, **(Figure 1)**. Open the hood. Starting on the driver side, remove the factory hex nut located on the back of the bumper bracket, **(Figure 2A)**. Drive the bumper bolt into the hole in the bracket to release the bolt from the metal retaining clip, **(Figure 3)**. **IMPORTANT: Do not damage threads on the factory bumper bolt!** Discard the metal clip. The factory bumper bolt is attached to a metal tab on the front bumper. Gently pry the metal tab away, (forward) from the bracket to pull the bolt out of the bracket, **(Figures 4 & 5)**. **NOTE:** The metal tab and bumper bolt can be moved by hand once released from the retaining clip. Access the bumper bolt through the opening behind the plastic bumper cover, **(Figure 5)**.
 - EcoBoost equipped vehicles:** The bumper bolt must be accessed from below/behind the front bumper or the crossmember mounting bracket for the intercooler may be temporarily removed, **(Figures 2A & 6)**.
- Pull the bumper bolt clear of the bracket and insert the driver side Frame Mounting Bracket into position between the plastic bumper cover and the bumper bracket, **(Figure 6)**. Line up the (2) mounting holes in the Frame Bracket with the holes in the bumper bracket. Insert the bumper bolt back through the Frame Mounting Bracket and bumper bracket and reinstall the factory hex nut. Do not tighten hardware at this time.

**EXTREME GRILLE GUARD
2009-2012 F150 (INCLUDES ECOBOOST)**

3. Repeat **Steps 1 & 2** for passenger side Mounting Bracket installation.
 - a. **Ecoboost equipped vehicles:** Reinstall the crossmember mounting bracket for the intercooler if removed in Step 2, (**Figure 2B**).
4. Open the hood and locate the top of the frame on the driver side. Use a flat blade screwdriver to gently pry up on the plastic clip on the top of the frame to move the rubber splash guard out of the way, (**Figure 7**). Select the driver side Inner Support Bracket, (**Figure 8**). **IMPORTANT:** Temporarily remove the plastic air dam-if equipped. Hold the Inner Bracket in position against the side of the frame. Insert (1) 12mm x 150mm Hex Bolt with (1) 12mm Flat Washer into and through the hole in the top of the Bracket. **NOTE:** Hex Bolt will rest on the top of the frame channel, (**Figures 8, 9 & 15**).
5. Next, select the driver side Outer Support Bracket. Hang the Bracket from the (1) 12mm x 150mm Hex Bolt, (**Figures 9 & 10**). Secure the Outer Bracket to the Inner Bracket with (1) 12mm Flat Washer and (1) 12mm Nylon Lock Nut. Repeat this step to secure the bottom of the Inner and Outer Support Brackets. **IMPORTANT:** Leave hardware completely loose, do not tighten hardware on the 12mm x 150mm Hex Bolts until installation is complete. **NOTE:** The sides of the frame are not flat at the mounting point so both brackets will be at slight angles to each other and not parallel, (**Figure 11**).
6. Repeat **Steps 4 – 5** for passenger side Support Bracket installation.
7. Once the driver and passenger side Support Bracket assemblies have been partially installed, push the Support Brackets as far forward on the frame as possible. **NOTE:** Hardware must be loose-remove the lower 12mm x 150mm Hex Bolt if necessary. Reinstall the air dam. Pull the Bracket assemblies back into position with the Outer Support Bracket against the body mount, (**Figures 11 & 15**). The Outer Support Bracket must be tight against the factory frame mount when properly installed, (**Figures 10, 11 & 15**). The Support Brackets are designed to fit over and around the factory air dam but depending on model and year, the air dam may require some trimming to clear the Outer Brackets, (**Figures 12 - 14**).
8. Line up the slot in the long, angled tab on the inner Support Bracket with the hole in the back of the factory bumper bracket next to the opening in the bumper, (**Figures 8 & 15**). This hole will also line up with the remaining hole in the Frame Mounting Bracket installed in **Step 2**. Insert (1) 12mm x 40mm Hex Bolt with (1) 12mm Flat Washer into the Frame Mounting Bracket and through the bumper bracket, (**Figure 8**). **NOTE:** Move the rubber splash guard behind and below the bumper. Secure the Inner Support Bracket to the Hex Bolt with (1) 12mm Flat Washer, (1) 12mm Lock Washer and (1) 12mm Hex Nut, (**Figures 8 & 15**). Snug but do not fully tighten hardware at this time.
9. Repeat **Step 8** for passenger side Inner Support Bracket installation.
10. With assistance, hold the Grille Guard up to the vehicle. Stands are highly recommended. Line up the (4) mounting holes in the Frame Mounting Brackets with the holes in the mounting plates on the Grille Guard. Bolt the Grille Guard to the Frame Brackets with (4) 12mm x 40mm Hex Bolts, (8) 12mm Flat Washers, (4) 12mm Lock Washers and (4) 12mm Hex Nuts, (**Figure 16**). Snug but do not tighten hardware at this time.
11. Next, move to the driver side lower mount welded to the Grille Guard. Line up the slot in the bottom of the Outer Support Bracket with the lower mount on the Grille Guard. Bolt the two Brackets together with (1) 12mm x 40mm Hex Bolt, (2) 12mm Flat Washers, (1) 12mm Lock Washer and (1) 12mm Hex Nut, (**Figure 17**). Snug but do not tighten hardware at this time.
12. Repeat **Step 11** to attach the passenger side lower Grille Guard mount.
13. Align, center and adjust the Grille Guard properly and tighten the Grille Guard and Frame Bracket hardware first. Once properly tightened, move to the Support Brackets. Hold the (2) Support Brackets tight against the frame and slowly tighten the hardware. Make sure that the (2) long Hex Bolts are tightened evenly to clamp the (2) Brackets against the frame, (**Figures 9, 11 & 15**). Once the Support Bracket hardware is tight, check and tighten all remaining hardware. Replace license plate if required.
14. Do periodic inspections to the installation to make sure that all hardware is secure and tight.

To protect your investment, wax this product after installing. Regular waxing is recommended to add a protective layer over the finish. Do not use any type of polish or wax that may contain abrasives that could damage the finish.

For gloss black finishes: Mild soap may be used to clean the Grille Guard.

Driver Side Installation Pictured

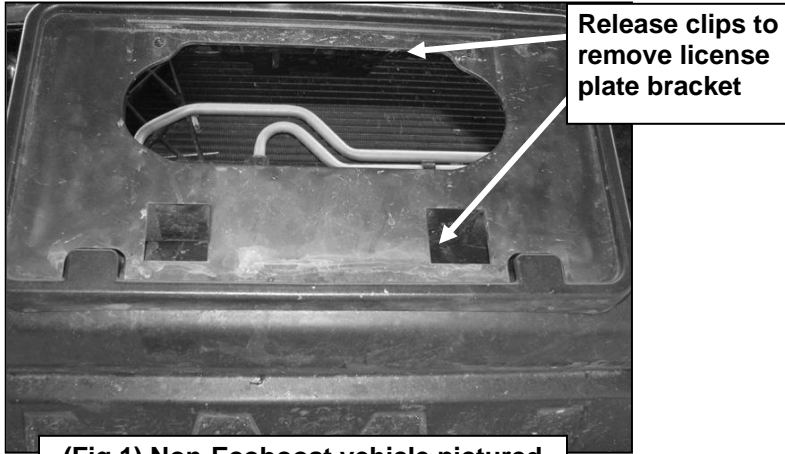

(Fig 1) Non-EcoBoost vehicle pictured

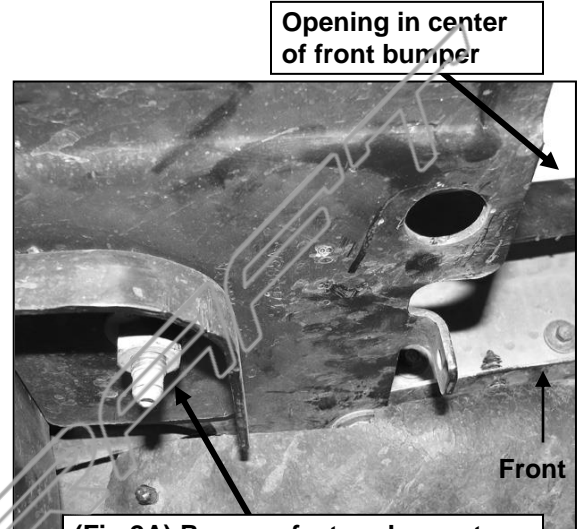

(Fig 2A) Remove factory hex nut (Driver side, non EcoBoost vehicle pictured from behind bumper)

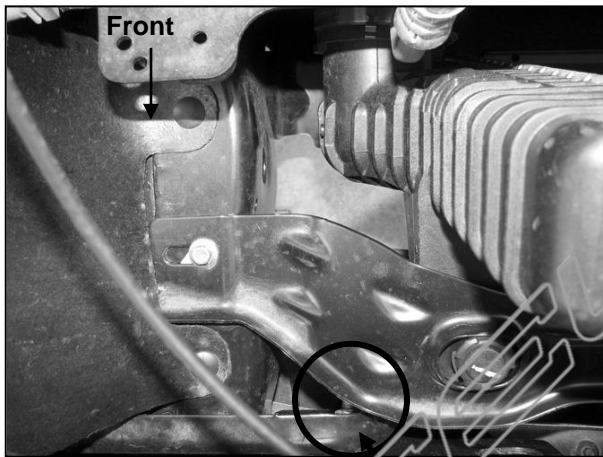

(Fig 2B) Remove bumper bracket hex nuts located under intercooler bracket (EcoBoost) (Passenger side pictured from above)

Pull/pry forward metal tab on bumper bolt to pull bolt out of bumper bracket

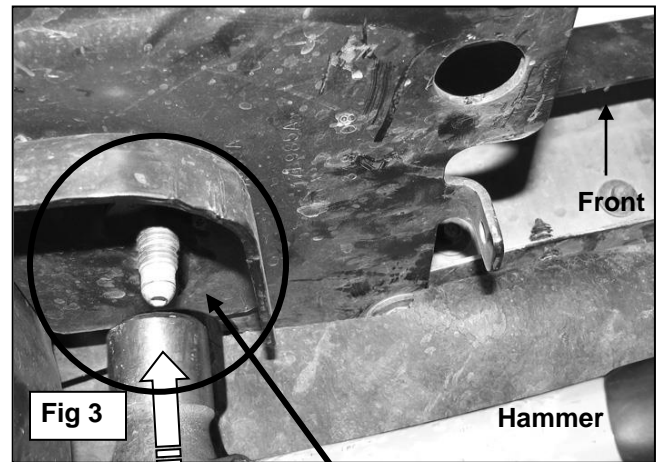

Remove factory hex nut. Drive bumper bolt back through hole with hammer to break tin retaining clip. IMPORTANT: Do not damage threads on bumper bolt!

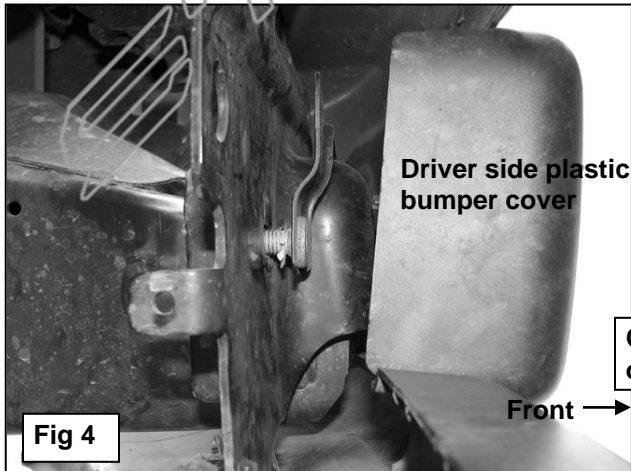
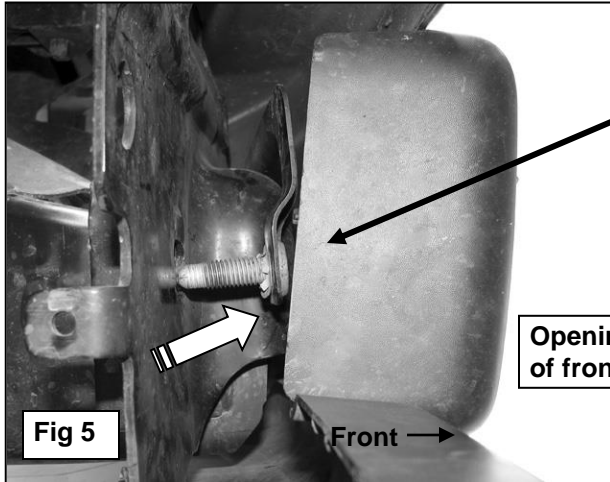

Fig 4

Driver Side Installation Pictured



Hold the bumper bolt out of the way and insert Frame Bracket between bumper cover and bumper bracket. Line up hole in Bracket with bumper bracket and reinsert bumper bolt

Insert through hole in Frame Bracket:
12mm x 40mm Hex Bolt
12mm Flat Washer

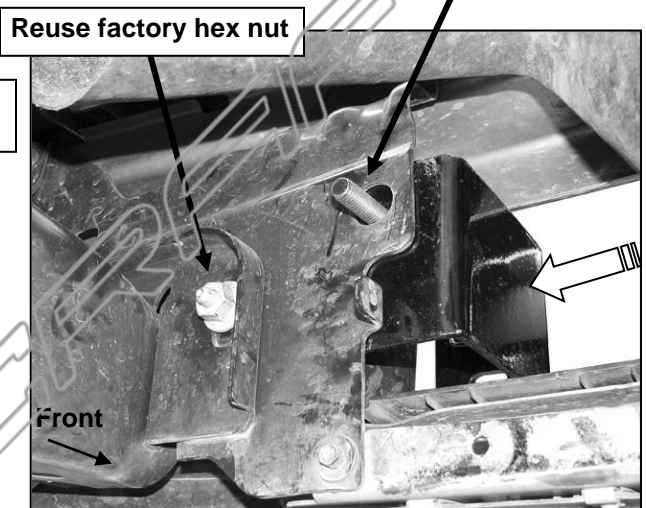

(Fig 6) Driver side viewed from behind bumper

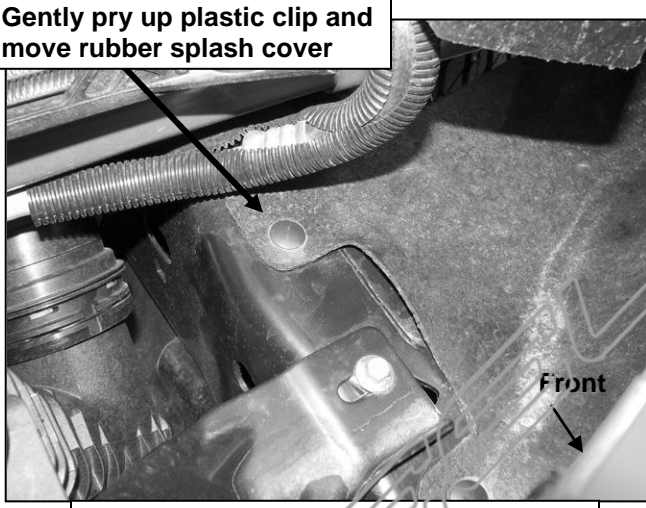

Gently pry up plastic clip and move rubber splash cover

12mm x 40mm Hex Bolt
(2) 12mm Flat Washers
12mm Lock Washer
12mm Hex Nut



(Fig 8) Inner Support Bracket pictured from behind front bumper

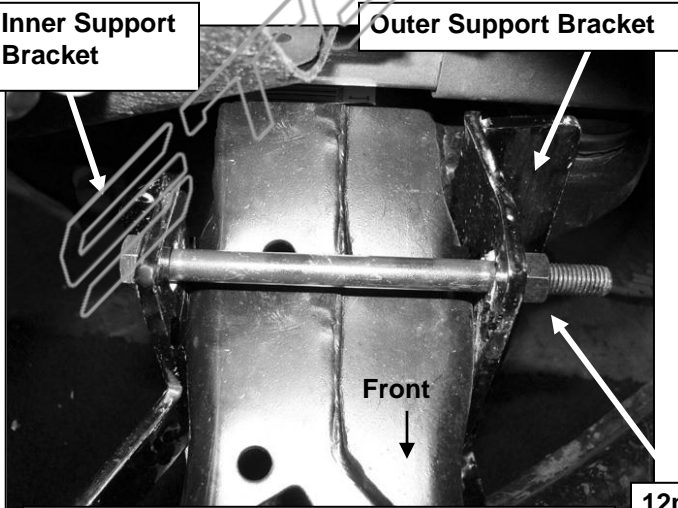

(Fig 9) Driver side Inner and Outer Support Brackets pictured from above. Note fit of Brackets against frame channel

12mm x 150mm Hex Bolt
(2) 12mm Flat Washers
12mm Nylon Lock Nut

**EXTREME GRILLE GUARD
2009-2012 F150 (INCLUDES ECOBOOST)**

Driver Side Installation Pictured

12mm x 150mm Hex Bolt
(2) 12mm Flat Washers
12mm Nylon Lock Nut

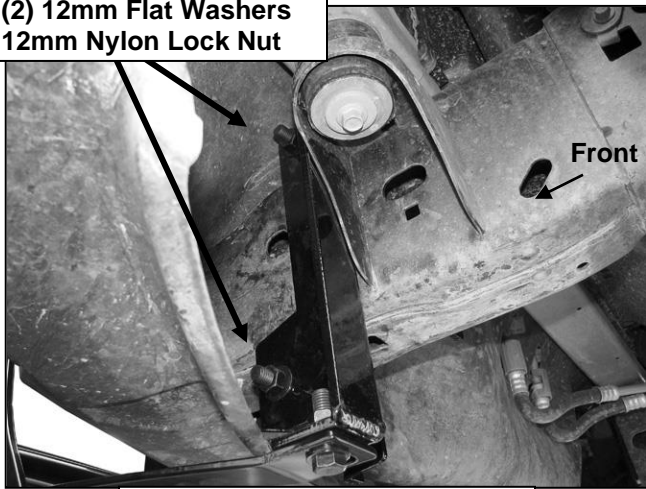

(Fig 10) Outer Support Bracket

Factory air dam mounts to each frame rail in this location.

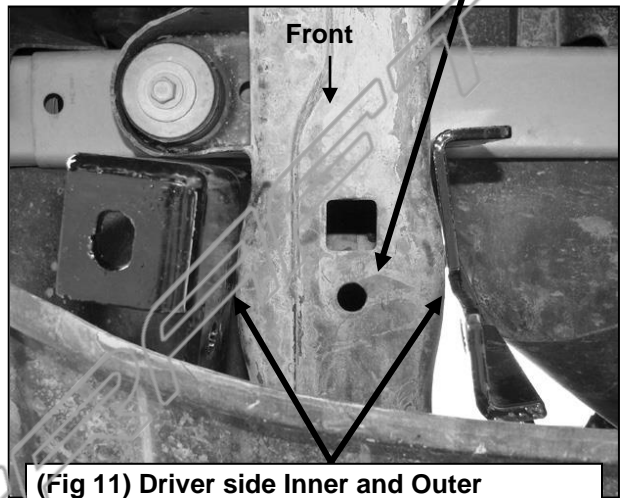

(Fig 11) Driver side Inner and Outer Support Brackets pictured from below. Note fit of Brackets against frame channel

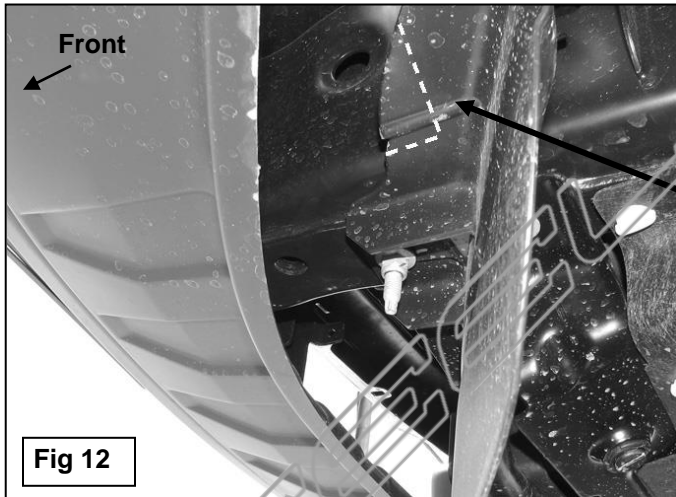
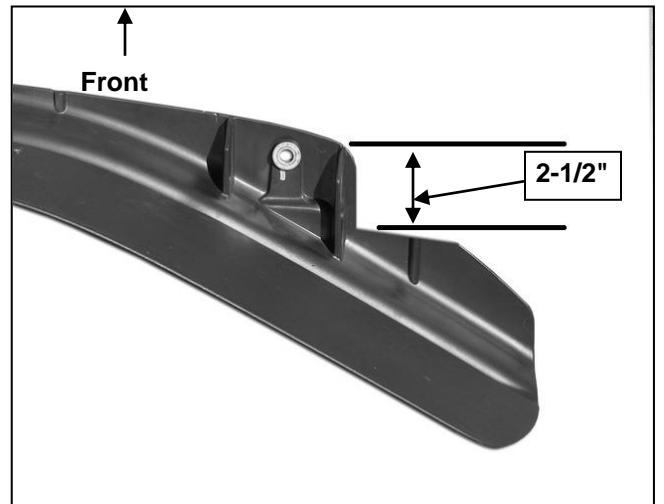

Fig 12

On some vehicles, it may be necessary to cut two small sections from the air dam to clear the outer brackets (see dashed line). Area represented for example only



(Fig 13) Bottom of driver/left side pictured

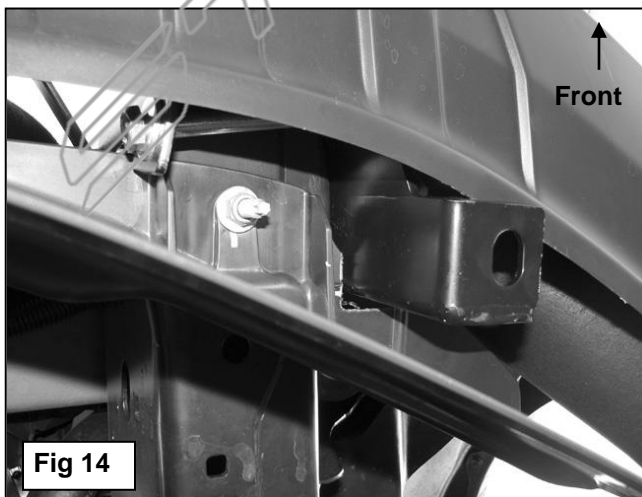

Fig 14

Driver Side Installation Pictured

- 12mm x 40mm Hex Bolt
- (2) 12mm Flat Washers
- 12mm Lock Washer
- 12mm Hex Nut

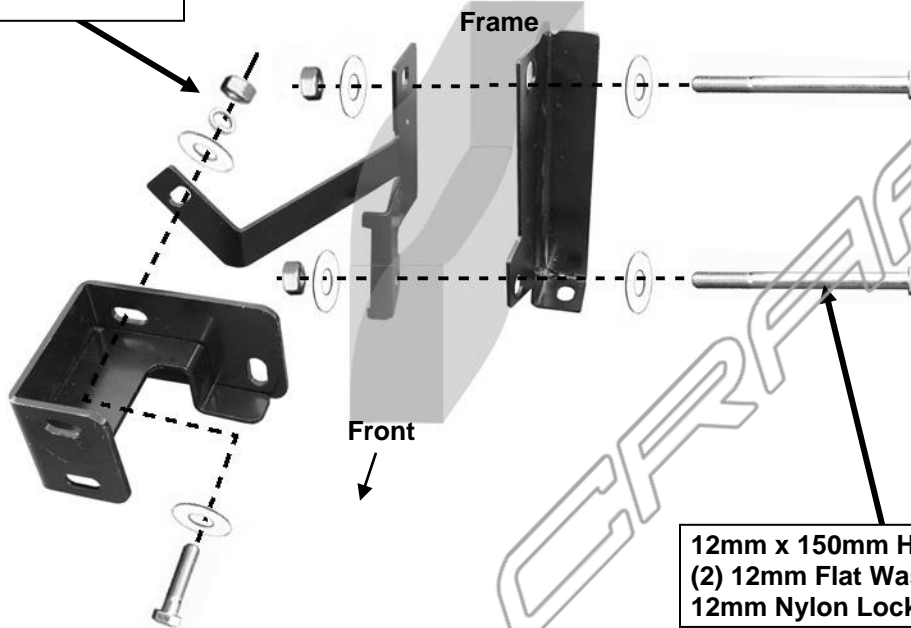
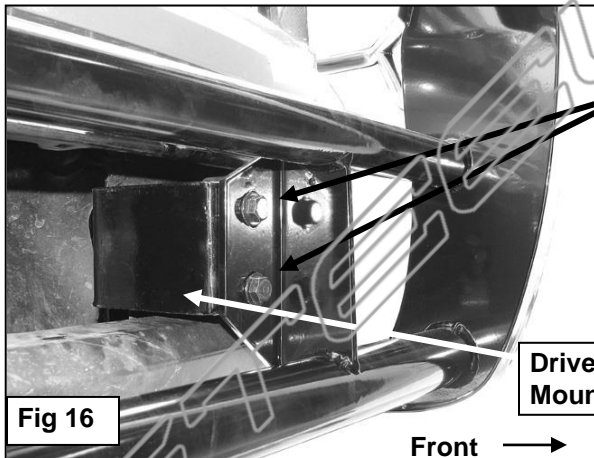

Fig 15

- 12mm x 150mm Hex Bolt
- (2) 12mm Flat Washers
- 12mm Nylon Lock Nut



- (2) 12mm x 40mm Hex Bolts
- (4) 12mm Flat Washers
- (2) 12mm Lock Washers
- (2) 12mm Hex Nuts

Driver/Left Frame
Mounting Bracket

Fig 16



Fig 17

- 12mm x 40mm Hex Bolt
- (2) 12mm Flat Washers
- 12mm Lock Washer
- 12mm Hex Nut



Complete Installation