



# 2015-2019 C7 Corvette Z06 103mm Plate System

PART NUMBER: 00-10167-Z06-XX

## INSTALLATION INSTRUCTIONS

This Nitrous Outlet plate system was designed specifically for the 2015-2019 Chevrolet Corvette Z06. If you need any assistance contact our Tech Help Line at (254) 848-4300.

### Tools Needed For Installation:

- Flathead Screwdriver
- Drill
- 7/16" Wrench
- Floor Jack
- T-40 Torx Bit
- 5mm Allen Wrench
- 10mm Socket
- 1" Drill Bit
- 9/16" Wrench
- 4 Jack Stands
- Impact Gun (Optional)
- 7mm Socket
- Ratchet Extension
- 11/16" Wrench
- T-15 Torx Bit
- Air Compressor
- Ratchet
- 3/8" Quick Disconnect Tool
- 3/8" Wrench
- T-30 Torx Bit
- 3/4" Socket

\*These are the tools required for installation of this kit on a stock vehicle. If your vehicle has aftermarket parts, other tools may be required.



### Step 1 – Battery Disconnection

- Open the rear hatch and pull back the carpet over the battery.



- Using a 10mm socket, loosen the nut and remove the negative battery terminal.



### Step 2 – Vehicle Disassembly

- Open the hood. Use a flathead screwdriver to loosen the clamp on the throttle body. After it's loose, remove the intake tube from the throttle body.

**IMPORTANT:** All appropriate safety equipment (gloves, tools etc.) must be used during the installation of this product(s). Nitro Dave's LLC accepts NO responsibility for injuries resulting in the installation of any product(s). Nitrous oxide is for off-road use only.

[WWW.NITROUSOUTLET.COM/INSTALLATION-GUIDES](http://WWW.NITROUSOUTLET.COM/INSTALLATION-GUIDES)



# 2015-2019 C7 Corvette Z06 103mm Plate System

PART NUMBER: 00-10167-Z06-XX

## INSTALLATION INSTRUCTIONS



- Disconnect the throttle position sensor.

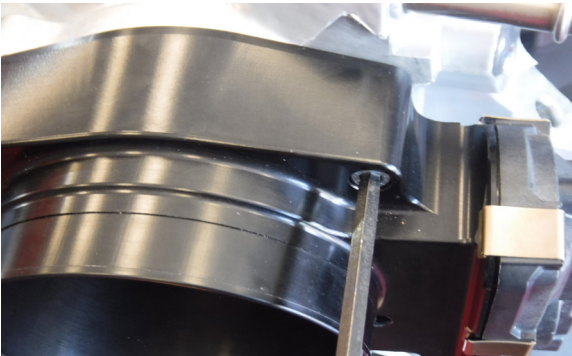

- Using a 5mm Allen wrench, remove the 4 bolts holding the throttle body and remove it from the vehicle.



- Locate the jack points on the vehicle, then use a floor jack to lift the vehicle. Be sure to use jackstands.



- Lift the vehicle completely off of the ground.

**IMPORTANT:** All appropriate safety equipment (gloves, tools etc.) must be used during the installation of this product(s). Nitro Dave's LLC accepts NO responsibility for injuries resulting in the installation of any product(s). Nitrous oxide is for off-road use only.

[WWW.NITROUSOUTLET.COM/INSTALLATION-GUIDES](http://WWW.NITROUSOUTLET.COM/INSTALLATION-GUIDES)



# 2015-2019 C7 Corvette Z06 103mm Plate System

PART NUMBER: 00-10167-Z06-XX

## INSTALLATION INSTRUCTIONS



- Use a 3/4" Socket and Ratchet or Impact gun to remove both wheels on the passenger side of the vehicle.



- On the passenger side rear of the vehicle, remove the five 7mm bolts below the mudflap. Then, remove the ten T-15 Torx bolts and single 10mm bolts.



- Use the trim too to remove the trim fasteners in the passenger side rear fender well.



- Gently remove the inner fender well from the vehicle.

**IMPORTANT:** All appropriate safety equipment (gloves, tools etc.) must be used during the installation of this product(s). Nitro Dave's LLC accepts NO responsibility for injuries resulting in the installation of any product(s). Nitrous oxide is for off-road use only.

[WWW.NITROUSOUTLET.COM/INSTALLATION-GUIDES](http://WWW.NITROUSOUTLET.COM/INSTALLATION-GUIDES)





# 2015-2019 C7 Corvette Z06 103mm Plate System

PART NUMBER: 00-10167-Z06-XX

## INSTALLATION INSTRUCTIONS



- On the front passenger side, use a 7mm socket to remove the four bolts on the bottom rear of the front fender. Then, remove the two 10mm bolts and remove the splash guard.



- Remove the three 7mm bolts in the front of the fender well.



- Remove the 8 bolts inside the front passenger side fender well with a T-15 Torx.



- Remove the 5 trim tabs inside the fender well. After the trim tabs are loose, remove the single 10mm bolt.

**IMPORTANT:** All appropriate safety equipment (gloves, tools etc.) must be used during the installation of this product(s). Nitro Dave's LLC accepts NO responsibility for injuries resulting in the installation of any product(s). Nitrous oxide is for off-road use only.

[WWW.NITROUSOUTLET.COM/INSTALLATION-GUIDES](http://WWW.NITROUSOUTLET.COM/INSTALLATION-GUIDES)





# 2015-2019 C7 Corvette Z06 103mm Plate System

PART NUMBER: 00-10167-Z06-XX

## INSTALLATION INSTRUCTIONS



- Remove the inner fender well by gently pulling down and outwards on it.



- In the engine bay, remove the 2 black plastic covers on the passenger side fender. There is 1 at the front and back of the fender.



- Lift the cowl on the passenger side of the vehicle and remove the single 7mm bolt on the fender. Then, remove the three T-15 Torx on top of the fender.



- Remove the three bolts that secure the bumper cover with a T-30 Torx Bit.

**IMPORTANT:** All appropriate safety equipment (gloves, tools etc.) must be used during the installation of this product(s). Nitro Dave's LLC accepts NO responsibility for injuries resulting in the installation of any product(s). Nitrous oxide is for off-road use only.

[WWW.NITROUSOUTLET.COM/INSTALLATION-GUIDES](http://WWW.NITROUSOUTLET.COM/INSTALLATION-GUIDES)



# 2015-2019 C7 Corvette Z06 103mm Plate System

PART NUMBER: 00-10167-Z06-XX

## INSTALLATION INSTRUCTIONS



- Use the trim tool to remove the 2 trim tabs on the front of the drivers and passenger side fender wells.



- Pop loose the bumper cover on the drivers and passenger side by gently pulling on it.



- Use a 7mm socket and extension to remove the bolts that hold the passenger side headlight.



- Remove the passenger side headlight from the vehicle.

**IMPORTANT:** All appropriate safety equipment (gloves, tools etc.) must be used during the installation of this product(s). Nitro Dave's LLC accepts NO responsibility for injuries resulting in the installation of any product(s). Nitrous oxide is for off-road use only.

[WWW.NITROUSOUTLET.COM/INSTALLATION-GUIDES](http://WWW.NITROUSOUTLET.COM/INSTALLATION-GUIDES)



# 2015-2019 C7 Corvette Z06 103mm Plate System

PART NUMBER: 00-10167-Z06-XX

## INSTALLATION INSTRUCTIONS



- Remove the two 10mm bolts under the headlight location.

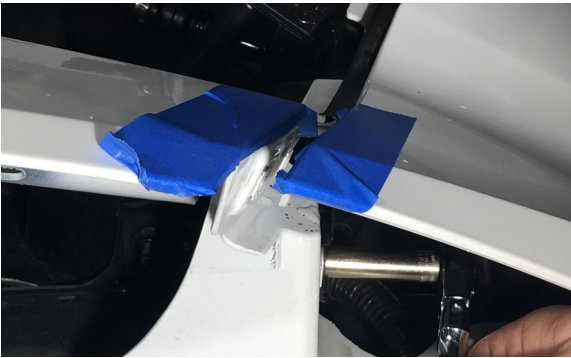

- Remove the single 10mm bolt at the rear of the fender near the PCM.



- Open the passenger side door of the vehicle, and remove the single 10mm bolt on the rear of the front fender.



- Gently remove the fender from the vehicle.

**IMPORTANT:** All appropriate safety equipment (gloves, tools etc.) must be used during the installation of this product(s). Nitro Dave's LLC accepts NO responsibility for injuries resulting in the installation of any product(s). Nitrous oxide is for off-road use only.

[WWW.NITROUSOUTLET.COM/INSTALLATION-GUIDES](http://WWW.NITROUSOUTLET.COM/INSTALLATION-GUIDES)





# 2015-2019 C7 Corvette Z06 103mm Plate System

PART NUMBER: 00-10167-Z06-XX

## INSTALLATION INSTRUCTIONS



- Remove the floor mat from the hatch area.



- Use a T-40 Torx to remove the 4 D-Rings in the hatch area.



- Use a trim tool to pop loose the plastic trim in the hatch area.



- Remove the trim from the hatch area of the vehicle.

**IMPORTANT:** All appropriate safety equipment (gloves, tools etc.) must be used during the installation of this product(s). Nitro Dave's LLC accepts NO responsibility for injuries resulting in the installation of any product(s). Nitrous oxide is for off-road use only.

[WWW.NITROUSOUTLET.COM/INSTALLATION-GUIDES](http://WWW.NITROUSOUTLET.COM/INSTALLATION-GUIDES)



# 2015-2019 C7 Corvette Z06 103mm Plate System

PART NUMBER: 00-10167-Z06-XX

## INSTALLATION INSTRUCTIONS



- Remove the carpet from the floor of the hatch area.



- Remove the speaker on the passenger side of the vehicle with a 7mm socket.



- Reach inside the speaker box and remove the foam insulation.



- Drill a 1" hole into the speaker box from inside the rear fender well. After the hole is drilled, place a grommet in the hole.

**IMPORTANT:** All appropriate safety equipment (gloves, tools etc.) must be used during the installation of this product(s). Nitro Dave's LLC accepts NO responsibility for injuries resulting in the installation of any product(s). Nitrous oxide is for off-road use only.

[WWW.NITROUSOUTLET.COM/INSTALLATION-GUIDES](http://WWW.NITROUSOUTLET.COM/INSTALLATION-GUIDES)



# 2015-2019 C7 Corvette Z06 103mm Plate System

PART NUMBER: 00-10167-Z06-XX

## INSTALLATION INSTRUCTIONS

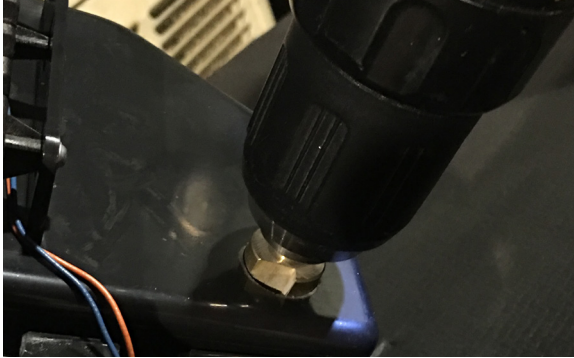

### Step 3 – Fuel Adapter Installation

- Remove the fuel line retainer clip on the fuel line. The fuel is located on the back drivers side of the supercharger.

**\*\*Note:** Make sure that the engine and exhaust are not hot before disconnecting the fuel feed.

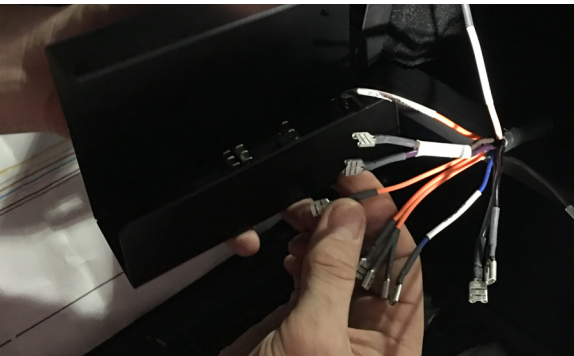

- Use a 3/8" Quick Disconnect tool to separate the fuel line from the injector rail. Placing a towel under the quick disconnect fitting will help keep the area clean of any fuel that is in the hose.



- Assemble the fuel adapter by putting a drop of blue Loc-Tite on the 1/8" NPT hex plug then with the fuel adapter positioned as shown, install the plug using a 3/16" Allen wrench.



- Apply blue loc-tite on the NPT threads of the 1/8 x 4AN 90° fitting. Then using a 3/8" wrench, install the fitting into the other fuel adapter opening. Orient the fitting so that it is just past parallel with the adapter.

**IMPORTANT:** All appropriate safety equipment (gloves, tools etc.) must be used during the installation of this product(s). Nitro Dave's LLC accepts NO responsibility for injuries resulting in the installation of any product(s). Nitrous oxide is for off-road use only.

[WWW.NITROUSOUTLET.COM/INSTALLATION-GUIDES](http://WWW.NITROUSOUTLET.COM/INSTALLATION-GUIDES)





# 2015-2019 C7 Corvette Z06 103mm Plate System

PART NUMBER: 00-10167-Z06-XX

## INSTALLATION INSTRUCTIONS



- Install the fuel adapter to the fuel supply line by sliding the female end over the fuel line until it rests against the fuel line flange. Then slide the fuel adapter nut over the fuel line and thread into the body of the fuel adapter. Using a 13/16" wrench tighten the adapter nut firmly into the adapter body pinching the fuel line flange between.



### Step 4 – Nitrous Plate Installation

- Make sure that the intake manifold and nitrous plate O-rings are intact and properly seated in place.

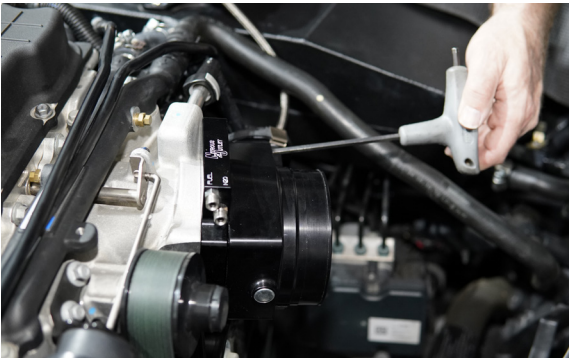

- Using a 5mm Allen wrench, install the nitrous plate between the throttle body and intake manifold with the provided 6mm bolts. Install the driver side bolts only, do not tighten them down.

**\*\*Note:** You should be able to properly read the engraved Nitrous Outlet logo while standing at the front of the vehicle.



### Step 5 – Solenoid Assembly Installation

- Remove the B-nut and ferrule from the straight fitting on the bottom of each solenoid.

**IMPORTANT:** All appropriate safety equipment (gloves, tools etc.) must be used during the installation of this product(s). Nitro Dave's LLC accepts NO responsibility for injuries resulting in the installation of any product(s). Nitrous oxide is for off-road use only.

[WWW.NITROUSOUTLET.COM/INSTALLATION-GUIDES](http://WWW.NITROUSOUTLET.COM/INSTALLATION-GUIDES)



# 2015-2019 C7 Corvette Z06 103mm Plate System

PART NUMBER: 00-10167-Z06-XX

## INSTALLATION INSTRUCTIONS



- Place the solenoid bracket assembly on front of the mounting holes on the passenger side of the throttle body. Put the 2 remaining throttle body mounting bolts into the holes, then tighten them down with a 10mm socket and ratchet. Evenly tighten down all the throttle body bolts.

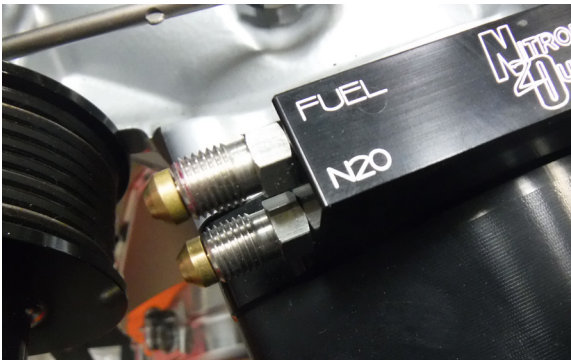

### Step 6 – Jet Installation

- Install the nitrous and fuel jet into the nitrous plate. The plate is engraved N2O for nitrous jet location and engraved FUEL for fuel jet location.

**\*\*Note:** Use the jet card that came with the nitrous system to choose the correct jetting recommendation for your desired horsepower.



### Step 7 – Hardline Installation

- Using the hardline with the black b-nut, slide the compression nut and ferrule on the opposite end of the b-nut.

**\*\*Note:** The nut slides on first and then the ferrule.

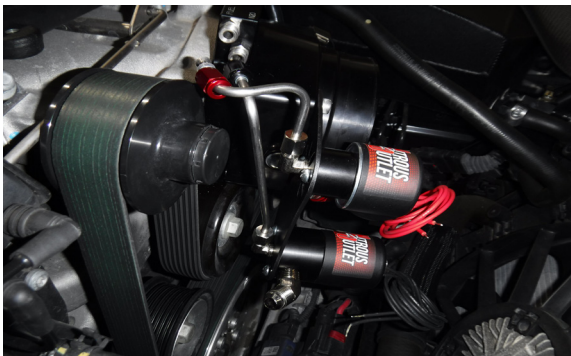

- Holding the nut and ferrule in place slide the hardline into the fuel solenoids exit fitting.

- Using a 3/8" wrench to hold the jet holder fitting and a 7/16" wrench to tighten the fuel hardline b-nut.

**\*\*Note:** Do not over tighten the b-nut, it only needs to be snugged.

**IMPORTANT:** All appropriate safety equipment (gloves, tools etc.) must be used during the installation of this product(s). Nitro Dave's LLC accepts NO responsibility for injuries resulting in the installation of any product(s). Nitrous oxide is for off-road use only.

[WWW.NITROUSOUTLET.COM/INSTALLATION-GUIDES](http://WWW.NITROUSOUTLET.COM/INSTALLATION-GUIDES)





# 2015-2019 C7 Corvette Z06 103mm Plate System

PART NUMBER: 00-10167-Z06-XX

## INSTALLATION INSTRUCTIONS

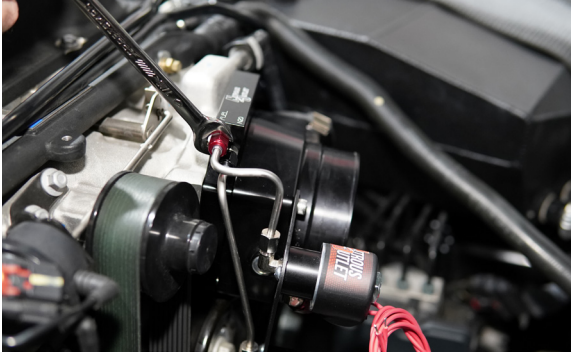

- Using a 7/16" wrench tighten the compression nuts at the solenoids.

**\*\*Note:** Tighten enough for the ferrule to compress.

- Repeat the same steps to install the nitrous hardline.

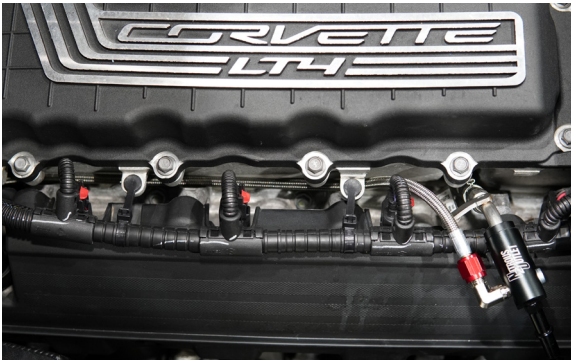

### Step 8 – Fuel Feed Line Installation

- Route the fuel hose along the top of the driver side cylinder head, and up to the front of the supercharger. Finger tighten the hose onto the fuel adapter.



- Route the fuel hose over the throttle body connector, under the throttle body and up the fuel solenoid. Tighten the hose onto the fuel solenoid with a 9/16" wrench.

**\*\*Note:** Make sure that the fuel hose is routed so that it does not make contact with the supercharger belt or pulley.



- Tighten the fuel hose onto the adapter with a 9/16" wrench.

**IMPORTANT:** All appropriate safety equipment (gloves, tools etc.) must be used during the installation of this product(s). Nitro Dave's LLC accepts NO responsibility for injuries resulting in the installation of any product(s). Nitrous oxide is for off-road use only.

[WWW.NITROUSOUTLET.COM/INSTALLATION-GUIDES](http://WWW.NITROUSOUTLET.COM/INSTALLATION-GUIDES)





# 2015-2019 C7 Corvette Z06 103mm Plate System

PART NUMBER: 00-10167-Z06-XX

## INSTALLATION INSTRUCTIONS



- Push the fuel hose onto the fuel adapter. When the fuel hose is properly seated, you will hear a faint click.



### Step 9 – Bottle Installation

- The most user friendly bottle mounting method is our C7 Bottle Mounting Plate (Part Number 00-33019). Not using the bottle mounting plate will require removal of the exhaust, suspension components, and will require drilling through the body. For additional bottle mounting info see the 2nd to last page of this installation guide.



### Step 10 – Nitrous Feed Line Installation

- Route the nitrous feed hose into the grommet in the speaker box.



- Route the nitrous feed hose through the grommet in the bottom of the speaker box and into the rear fender well.

**IMPORTANT:** All appropriate safety equipment (gloves, tools etc.) must be used during the installation of this product(s). Nitro Dave's LLC accepts NO responsibility for injuries resulting in the installation of any product(s). Nitrous oxide is for off-road use only.

[WWW.NITROUSOUTLET.COM/INSTALLATION-GUIDES](http://WWW.NITROUSOUTLET.COM/INSTALLATION-GUIDES)



# 2015-2019 C7 Corvette Z06 103mm Plate System

PART NUMBER: 00-10167-Z06-XX

## INSTALLATION INSTRUCTIONS



- Using a wire fishing pole, route the nitrous hose through the passenger side rocker panel of the vehicle.



- When the nitrous feed hose has reached the front of the rocker panel, pull it through enough that you can reach the front of the engine bay.



- Route the nitrous feed hose through the frame of the vehicle and into the engine bay.



- Route the nitrous feed hose through the engine bay and up to the nitrous solenoid. Use an air hose to blow through the nitrous hose and clear it of any debris. Then tighten onto the nitrous solenoid inlet fitting with an 11/16" wrench.

**IMPORTANT:** All appropriate safety equipment (gloves, tools etc.) must be used during the installation of this product(s). Nitro Dave's LLC accepts NO responsibility for injuries resulting in the installation of any product(s). Nitrous oxide is for off-road use only.

[WWW.NITROUSOUTLET.COM/INSTALLATION-GUIDES](http://WWW.NITROUSOUTLET.COM/INSTALLATION-GUIDES)



# 2015-2019 C7 Corvette Z06 103mm Plate System

PART NUMBER: 00-10167-Z06-XX

## INSTALLATION INSTRUCTIONS

NITROUS OUTLET — UNIVERSAL SINGLE STAGE WIRING DIAGRAM

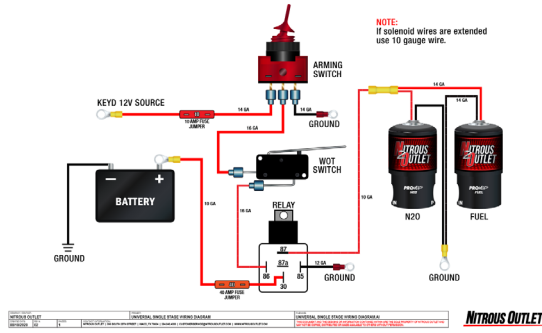

### Step 11 – Wiring

- This step will cross over into the installation of other components you are installing in conjunction with the nitrous system, such as nitrous controller, bottle heater, purge etc. Using the diagrams that came with those components route the wiring.

**\*\*Note:** The diagram to the left is a basic system diagram with a WOT Switch.

To view a larger diagram, turn to the last page of these instructions, however you should be using a nitrous controller that incorporates a window safety switch with TPS activation.



### Step 12 – Final Check Over

- Reconnect the battery.
- Key car on and let the system prime. Check all fuel system components for fuel leaks.
- With the nitrous bottle still closed check the system functions to ensure proper wiring and proper settings of any electronic controllers.
- With the nitrous system deactivated open the nitrous bottle and check for any nitrous leaks.



### Step 13 – Final Assembly

- Reinstall the trunk speaker, making sure to place the speaker foam back in place.



- Replace the trunk carpet.

**IMPORTANT:** All appropriate safety equipment (gloves, tools etc.) must be used during the installation of this product(s). Nitro Dave's LLC accepts NO responsibility for injuries resulting in the installation of any product(s). Nitrous oxide is for off-road use only.

[WWW.NITROUSOUTLET.COM/INSTALLATION-GUIDES](http://WWW.NITROUSOUTLET.COM/INSTALLATION-GUIDES)





# 2015-2019 C7 Corvette Z06 103mm Plate System

PART NUMBER: 00-10167-Z06-XX

## INSTALLATION INSTRUCTIONS

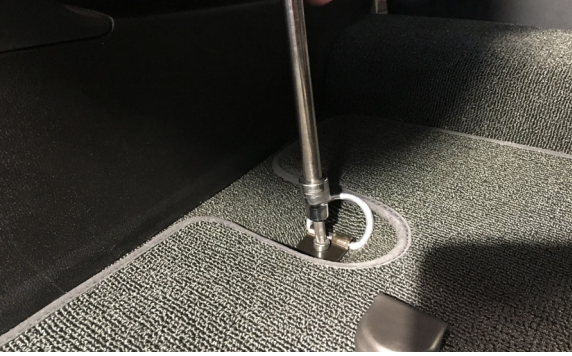

- Replace the 4 D-Rings in the hatch area.



- Replace the trunk trim panel.



- Replace the trunk floor mat.



- Reinstall the front fender.

**IMPORTANT:** All appropriate safety equipment (gloves, tools etc.) must be used during the installation of this product(s). Nitro Dave's LLC accepts NO responsibility for injuries resulting in the installation of any product(s). Nitrous oxide is for off-road use only.

[WWW.NITROUSOUTLET.COM/INSTALLATION-GUIDES](http://WWW.NITROUSOUTLET.COM/INSTALLATION-GUIDES)



# 2015-2019 C7 Corvette Z06 103mm Plate System

PART NUMBER: 00-10167-Z06-XX

## INSTALLATION INSTRUCTIONS



- Reinstall the headlight.



- Reinstall the three bumper cover bolts.



- Reinstall the 2 black plastic covers on the passenger side fender.



- Reinstall the inner fender well.

**IMPORTANT:** All appropriate safety equipment (gloves, tools etc.) must be used during the installation of this product(s). Nitro Dave's LLC accepts NO responsibility for injuries resulting in the installation of any product(s). Nitrous oxide is for off-road use only.

[WWW.NITROUSOUTLET.COM/INSTALLATION-GUIDES](http://WWW.NITROUSOUTLET.COM/INSTALLATION-GUIDES)



# 2015-2019 C7 Corvette Z06 103mm Plate System

PART NUMBER: 00-10167-Z06-XX

## INSTALLATION INSTRUCTIONS



- Reinstall the wheels.



- Reconnect the throttle position sensor.

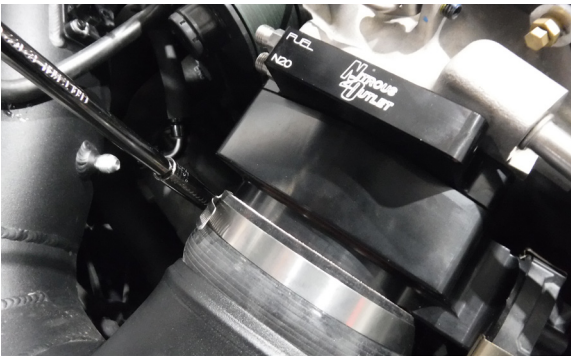

- Reinstall the intake air tube.



### CONCLUSION

You have finished your installation.

**IMPORTANT:** All appropriate safety equipment (gloves, tools etc.) must be used during the installation of this product(s). Nitro Dave's LLC accepts NO responsibility for injuries resulting in the installation of any product(s). Nitrous oxide is for off-road use only.

[WWW.NITROUSOUTLET.COM/INSTALLATION-GUIDES](http://WWW.NITROUSOUTLET.COM/INSTALLATION-GUIDES)





# 2015-2019 C7 Corvette Z06 103mm Plate System

PART NUMBER: 00-10167-Z06-XX

## INSTALLATION INSTRUCTIONS

### Bottle Mounting Information

It's very important to mount your bottle in the proper orientation. Ideally, the bottle should be facing with the valve to the front of the vehicle. This is because the siphon tube inside the bottle is curved towards the bottom of the bottle, so it can pick up a steady supply of nitrous. In the event your bottle cannot be mounted front to back, you can mount it at an angle, or even sideways. If you mount the bottle sideways, you'll need to rotate the bottle so that the siphon tube is at a 45° angle. This means the bottle nipple will be facing towards the back of the vehicle at a 45° angle. This is because upon acceleration, the nitrous can be pulled away from the siphon tube. With it at an angle it still allows the siphon tube to be submerged in the nitrous. The siphon tube on Nitrous Outlet bottles are curved in the same direction as the bottle nipple. If the bottle is mounted front-to-back, the nipple should be facing down towards the floor of the vehicle. If you have any questions about mounting your bottle, call our Tech Help line at (254) 848-4300.



**IMPORTANT:** All appropriate safety equipment (gloves, tools etc.) must be used during the installation of this product(s). Nitro Dave's LLC accepts NO responsibility for injuries resulting in the installation of any product(s). Nitrous oxide is for off-road use only.

[WWW.NITROUSOUTLET.COM/INSTALLATION-GUIDES](http://WWW.NITROUSOUTLET.COM/INSTALLATION-GUIDES)



# System Wiring Diagram

NITROUS OUTLET — UNIVERSAL SINGLE STAGE WIRING DIAGRAM

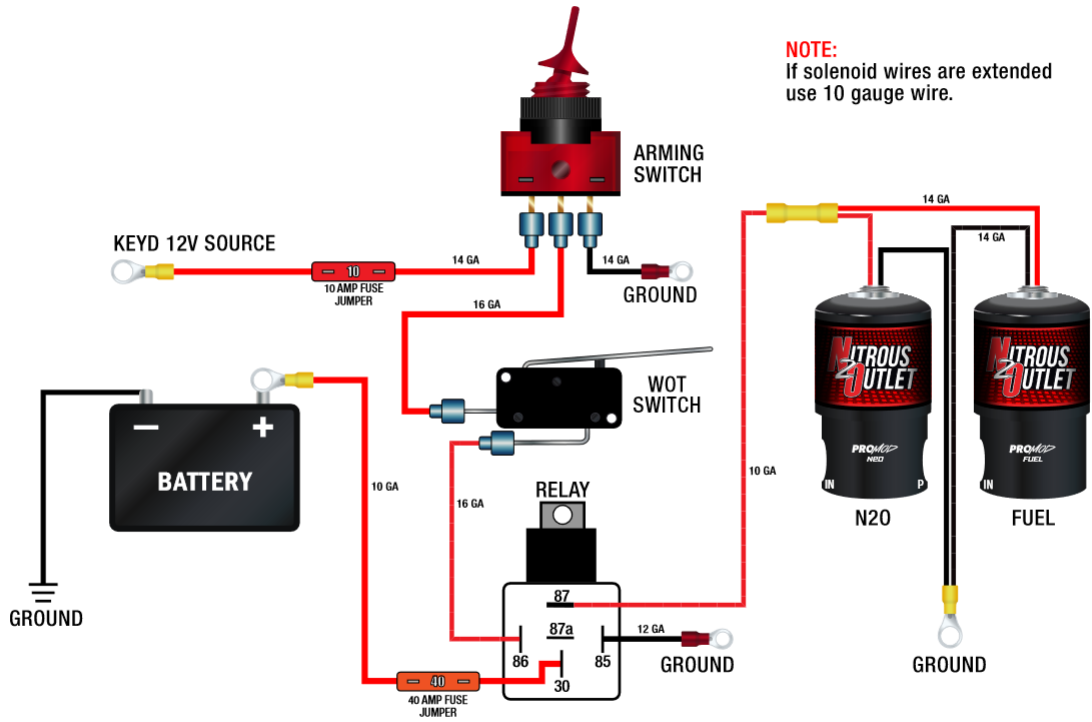

**NOTE:**  
If solenoid wires are extended use 10 gauge wire.

<small>COMPANY CONTACT</small> <b>NITROUS OUTLET</b> <small>REVISED DATE</small> 08/10/2020   <small>REV</small> 02   <small>PRINTED</small> 1 <small>COMPANY INFORMATION</small> NITROUS OUTLET   305 SOUTH 28TH STREET   WACO, TX 76764   254.848.4300   CUSTOMERSERVICE@NITROUSOUTLET.COM   WWW.NITROUSOUTLET.COM	<small>PROJECT</small> <b>UNIVERSAL SINGLE STAGE WIRING DIAGRAM</b>	<small>FILENAME</small> <b>UNIVERSAL SINGLE STAGE WIRING DIAGRAM.AI</b> <small>THIS DOCUMENT AND THE SERVICE OR INFORMATION CONTAINED WITHIN ARE THE SOLE PROPERTY OF NITROUS OUTLET AND MAY NOT BE COPIED, REPRODUCED OR MADE AVAILABLE TO OTHERS WITHOUT PERMISSION.</small>
--	--	--



**IMPORTANT:** All appropriate safety equipment (gloves, tools etc.) must be used during the installation of this product(s). Nitro Dave's LLC accepts NO responsibility for injuries resulting in the installation of any product(s). Nitrous oxide is for off-road use only.

[WWW.NITROUSOUTLET.COM/INSTALLATION-GUIDES](http://WWW.NITROUSOUTLET.COM/INSTALLATION-GUIDES)