



# 2009-2014 CADILLAC CTS-V

SUPERCHARGER SPRAY BAR SYSTEM 00-10171-XX

INSTALLATION INSTRUCTIONS

**This Nitrous Outlet Supercharger Spray Bar System is designed specifically for the 2009-2014 Cadillac CTS-V. If you need any assistance during installation or if you have questions about this wiring harness, call our Tech Help Line at (254) 848-4300.**

*\*\*\*Parts List included in the back of this Installation Guide\*\*\**

## Tools Needed For Installation:

- Ratchet
- Ratchet Extension
- 18mm Socket
- 13mm Socket
- 10mm Socket
- T-50 Torx
- 7/16" Wrench
- 9/16" Wrench
- 11/16" Wrench



### Step 1:

Remove the plastic engine covers from the engine bay. Gently lift upwards on them to release them from their retaining clips.



### Step 2:

Use a 18mm socket to remove the mounting bolts for the strut tower brace. There is 1 bolt and 1 nut on each side of the brace.

305 S. 28th street Waco, TX 76710 - TEL 254-848-4300

WWW.NITROUSOUTLET.COM

IMPORTANT- ALL APPROPRIATE SAFETY EQUIPMENT (GLOVES, TOOLS ETC.) MUST BE USED DURING THE INSTALLATION OF THIS PRODUCT(S).  
NITRO DAVE'S LLC ACCEPTS NO RESPONSIBILITY FOR INJURIES RESULTING IN THE INSTALLATION OF ANY PRODUCT(S). NITROUS OXIDE IS FOR OFF-ROAD USE ONLY.



# 2009-2014 CADILLAC CTS-V SUPERCHARGER SPRAY BAR SYSTEM 00-10171-XX

## INSTALLATION INSTRUCTIONS



### Step 3:

Remove the strut tower brace from the vehicle.

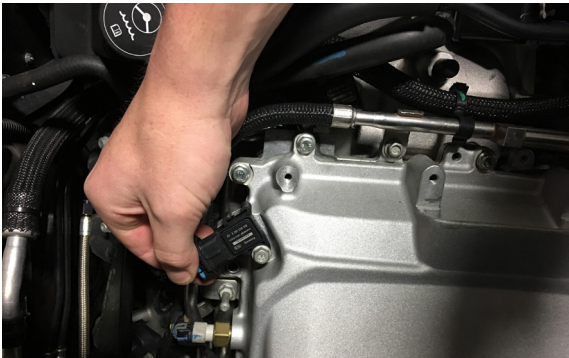

### Step 4:

Unplug the 3 sensors on the supercharger lid. Simply push the release tab, and pull the plug out of the sensors.



### Step 5:

Use a ratchet, extension and 10mm socket to remove the bolts that hold the supercharger lid.



### Step 6:

Lift off the supercharger lid. Remove the factory gaskets from the supercharger and replace them with the gaskets that came with your nitrous system. Place the factory gaskets in the grooves of the nitrous spraybar plate.

305 S. 28th street Waco, TX 76710 - TEL 254-848-4300

WWW.NITROUSOUTLET.COM

IMPORTANT- ALL APPROPRIATE SAFETY EQUIPMENT (GLOVES, TOOLS ETC.) MUST BE USED DURING THE INSTALLATION OF THIS PRODUCT(S).  
NITRO DAVE'S LLC ACCEPTS NO RESPONSIBILITY FOR INJURIES RESULTING IN THE INSTALLATION OF ANY PRODUCT(S). NITROUS OXIDE IS FOR OFF-ROAD USE ONLY.



# 2009-2014 CADILLAC CTS-V

SUPERCHARGER SPRAY BAR SYSTEM 00-10171-XX

## INSTALLATION INSTRUCTIONS



### Step 7:

Place the intercooler spacer and gasket in place of the factory gasket.



### Step 8:

Place the spray bar plate into the supercharger. The inlet fittings should be at the front of the supercharger and facing upwards.



### Step 9:

Lower the supercharger lid onto the spraybar plate and ensure it sits flat on the supercharger.

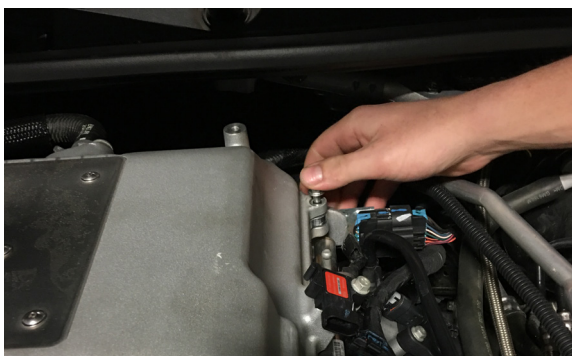

### Step 10:

Use the included bolts to tighten down the supercharger lid with a 10mm socket and ratchet. Do not put any bolts in the 2nd hole back from the front on each side.

305 S. 28th street Waco, TX 76710 - TEL 254-848-4300

WWW.NITROUSOUTLET.COM

IMPORTANT- ALL APPROPRIATE SAFETY EQUIPMENT (GLOVES, TOOLS ETC.) MUST BE USED DURING THE INSTALLATION OF THIS PRODUCT(S).  
NITRO DAVE'S LLC ACCEPTS NO RESPONSIBILITY FOR INJURIES RESULTING IN THE INSTALLATION OF ANY PRODUCT(S). NITROUS OXIDE IS FOR OFF-ROAD USE ONLY.



# 2009-2014 CADILLAC CTS-V

## SUPERCHARGER SPRAY BAR SYSTEM 00-10171-XX

### INSTALLATION INSTRUCTIONS

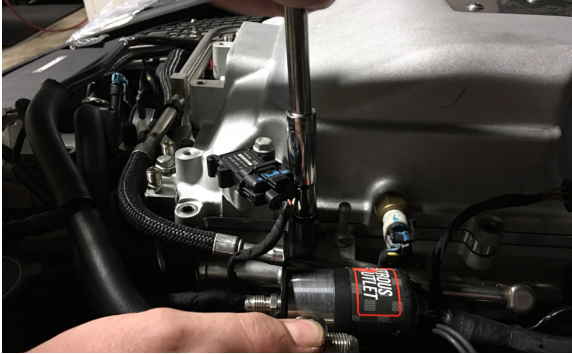

#### Step 11:

The nitrous and fuel solenoid brackets will mount on the 2nd bolt back from the front of the supercharger. Place a spacer between the supercharger lid and solenoid bracket, then tighten the bolt down with a 10mm socket and ratchet. The nitrous solenoid will mount on the drivers side and the fuel solenoid will mount on the passenger side.

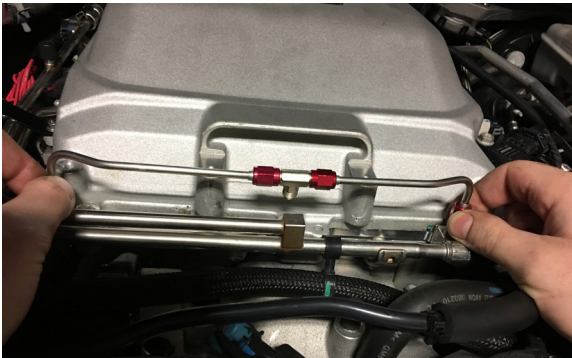

#### Step 12:

Assemble the fuel hardlines by threading them onto the T fitting. Do not tighten them at this point. Use the jet chart that came with your nitrous system to select the proper jetting, then put the jets in the fuel inlet fittings. Then, tighten the fuel hard lines onto the inlet fittings.

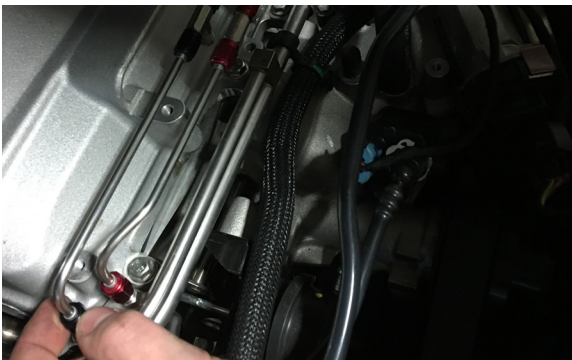

#### Step 13:

Assemble the nitrous hardlines by threading them onto the T fitting. Do not tighten them at this point. Use the jet chart that came with your nitrous system to select the proper jetting, then put the jets in the nitrous inlet fittings. Then, tighten the nitrous hard lines onto the inlet fittings.



#### Step 14:

Tighten the hard lines onto the plate and T fittings with a 7/16" wrench. Do not over-tighten the lines.

305 S. 28th street Waco, TX 76710 - TEL 254-848-4300

WWW.NITROUSOUTLET.COM

IMPORTANT- ALL APPROPRIATE SAFETY EQUIPMENT (GLOVES, TOOLS ETC.) MUST BE USED DURING THE INSTALLATION OF THIS PRODUCT(S).  
NITRO DAVE'S LLC ACCEPTS NO RESPONSIBILITY FOR INJURIES RESULTING IN THE INSTALLATION OF ANY PRODUCT(S). NITROUS OXIDE IS FOR OFF-ROAD USE ONLY.



# 2009-2014 CADILLAC CTS-V

SUPERCHARGER SPRAY BAR SYSTEM 00-10171-XX

## INSTALLATION INSTRUCTIONS



### Step 15:

Thread the straight end of the fuel hose onto the outlet fitting of the fuel solenoid.

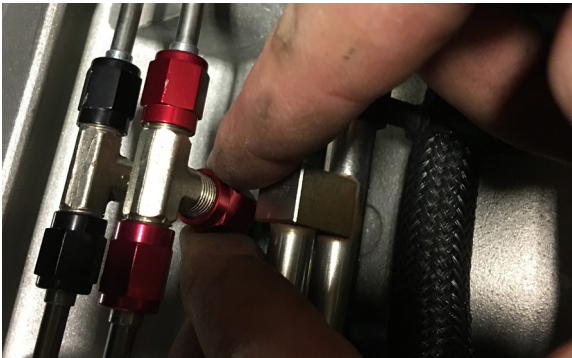

### Step 16:

Thread the 90° end of the fuel hose onto the T fitting. Then tighten the fuel hose onto the solenoid with a 9/16" wrench. Tighten the other end of the fuel hose onto the T with a 7/16" wrench.



### Step 17:

Thread the straight end of the nitrous hose onto the outlet fitting of the nitrous solenoid.



### Step 18:

Thread the 90° end of the nitrous hose onto the T fitting. Then tighten the nitrous hose onto the solenoid with a 9/16" wrench. Tighten the other end of the nitrous hose onto the T with a 7/16" wrench.

305 S. 28th street Waco, TX 76710 - TEL 254-848-4300

WWW.NITROUSOUTLET.COM

IMPORTANT- ALL APPROPRIATE SAFETY EQUIPMENT (GLOVES, TOOLS ETC.) MUST BE USED DURING THE INSTALLATION OF THIS PRODUCT(S).  
NITRO DAVE'S LLC ACCEPTS NO RESPONSIBILITY FOR INJURIES RESULTING IN THE INSTALLATION OF ANY PRODUCT(S). NITROUS OXIDE IS FOR OFF-ROAD USE ONLY.



# 2009-2014 CADILLAC CTS-V

## SUPERCHARGER SPRAY BAR SYSTEM 00-10171-XX

### INSTALLATION INSTRUCTIONS



#### Step 19:

Locate the schrader valve on the passenger side fuel rail. Using a schrader valve core removal tool, remove the valve core.



#### Step 20:

Thread the 90° swivel fitting onto the fuel rail. Then, thread the fuel supply hard line onto the swivel and fuel solenoid inlet port. Tighten the swivel and hard line with a 9/16" wrench.



#### Step 21:

Remove the back seat of the vehicle by lifting up on each side of the seat.



#### Step 22:

Remove the back seat from the cabin of the vehicle.

305 S. 28th street Waco, TX 76710 - TEL 254-848-4300

WWW.NITROUSOUTLET.COM

IMPORTANT- ALL APPROPRIATE SAFETY EQUIPMENT (GLOVES, TOOLS ETC.) MUST BE USED DURING THE INSTALLATION OF THIS PRODUCT(S).  
NITRO DAVE'S LLC ACCEPTS NO RESPONSIBILITY FOR INJURIES RESULTING IN THE INSTALLATION OF ANY PRODUCT(S). NITROUS OXIDE IS FOR OFF-ROAD USE ONLY.



# 2009-2014 CADILLAC CTS-V

SUPERCHARGER SPRAY BAR SYSTEM 00-10171-XX

## INSTALLATION INSTRUCTIONS



### Step 23:

Slide the drivers side seat completely forward. Then, use a trim tool to remove the trim pieces that cover the back of the seats mounting rails.



### Step 24:

Use a T-50 Torx bit to remove the 2 seat mounting bolts on the back of the drivers seat.



### Step 25:

Disconnect the battery of the vehicle and unplug the 3 electrical connections on front of the drivers seat.



### Step 26:

Tilt the drivers seat forward, and pull the base of the seat to the rear to release the mounting hooks on front of the seat.

305 S. 28th street Waco, TX 76710 - TEL 254-848-4300

WWW.NITROUSOUTLET.COM

IMPORTANT- ALL APPROPRIATE SAFETY EQUIPMENT (GLOVES, TOOLS ETC.) MUST BE USED DURING THE INSTALLATION OF THIS PRODUCT(S).  
NITRO DAVE'S LLC ACCEPTS NO RESPONSIBILITY FOR INJURIES RESULTING IN THE INSTALLATION OF ANY PRODUCT(S). NITROUS OXIDE IS FOR OFF-ROAD USE ONLY.



# 2009-2014 CADILLAC CTS-V

## SUPERCHARGER SPRAY BAR SYSTEM 00-10171-XX

### INSTALLATION INSTRUCTIONS



#### Step 27:

Remove the seat and front carpet from the cabin of the vehicle.



#### Step 28:

Starting at the trunk of the vehicle, route the nitrous feed hose under the back seat.



#### Step 29:

Route the nitrous feed hose through the back seat area, and under the carpet next to the factory wiring harness.



#### Step 30:

Reach under the carpet and pull the nitrous feed hose along the transmission tunnel.

305 S. 28th street Waco, TX 76710 - TEL 254-848-4300

WWW.NITROUSOUTLET.COM

IMPORTANT- ALL APPROPRIATE SAFETY EQUIPMENT (GLOVES, TOOLS ETC.) MUST BE USED DURING THE INSTALLATION OF THIS PRODUCT(S).  
NITRO DAVE'S LLC ACCEPTS NO RESPONSIBILITY FOR INJURIES RESULTING IN THE INSTALLATION OF ANY PRODUCT(S). NITROUS OXIDE IS FOR OFF-ROAD USE ONLY.





# 2009-2014 CADILLAC CTS-V

SUPERCHARGER SPRAY BAR SYSTEM 00-10171-XX

## INSTALLATION INSTRUCTIONS

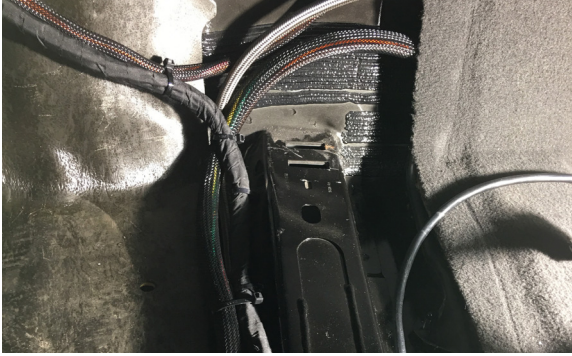

### Step 31:

Route the nitrous feed hose next to the factory wiring harness. It should cross the floor of the vehicle, and continue along the drivers side kick panel.



### Step 32:

Push the nitrous feed hose through the firewall where the factory harness passes through. Simply push it through the rubber seal and into the engine bay.



### Step 33:

Route the nitrous feed hose through the engine bay and to the nitrous solenoid inlet fitting. Use an air compressor to blow through the hose and clear it of any debris. Then, tighten the hose onto the nitrous solenoid inlet fitting with a 11/16" wrench.



### Step 34:

Your hardware install is now complete and you can begin reassembly. Use the attached wiring diagram to finish your installation. After wiring your system, check all fittings and joints for leaks.

305 S. 28th street Waco, TX 76710 - TEL 254-848-4300

WWW.NITROUSOUTLET.COM

IMPORTANT- ALL APPROPRIATE SAFETY EQUIPMENT (GLOVES, TOOLS ETC.) MUST BE USED DURING THE INSTALLATION OF THIS PRODUCT(S).  
NITRO DAVE'S LLC ACCEPTS NO RESPONSIBILITY FOR INJURIES RESULTING IN THE INSTALLATION OF ANY PRODUCT(S). NITROUS OXIDE IS FOR OFF-ROAD USE ONLY.



# 2009-2014 CADILLAC CTS-V

## SUPERCHARGER SPRAY BAR SYSTEM 00-10171-XX

### INSTALLATION INSTRUCTIONS

#### Bottle Mounting Information

It's very important to mount your bottle in the proper orientation. Ideally, the bottle should be facing with the valve to the front. This is because the siphon tube inside the bottle is curved towards the bottom of the bottle, so it can pick up a steady supply of nitrous. In the event your bottle cannot be mounted front to back, you can mount it at an angle, or even sideways. If you mount the bottle sideways, you'll need to rotate the bottle so that the siphon tube is at a 45° angle. This means the bottle nipple will be facing the back of the vehicle at a 45° angle. This is because upon acceleration, the nitrous can be pulled away from the siphon tube, and with it at an angle it still allows the siphon tube to be submerged in the nitrous. The siphon tube on Nitrous Outlet bottles are curved in the same direction as the bottle nipple. If the bottle is mounted front-to-back, the nipple should be facing down towards the floor of the vehicle. If you have any questions about mounting your bottle, call our Tech Help line at (254) 848-4300.



305 S. 28th street Waco, TX 76710 - TEL 254-848-4300

WWW.NITROUSOUTLET.COM

IMPORTANT- ALL APPROPRIATE SAFETY EQUIPMENT (GLOVES, TOOLS ETC.) MUST BE USED DURING THE INSTALLATION OF THIS PRODUCT(S).  
NITRO DAVE'S LLC ACCEPTS NO RESPONSIBILITY FOR INJURIES RESULTING IN THE INSTALLATION OF ANY PRODUCT(S). NITROUS OXIDE IS FOR OFF-ROAD USE ONLY.



# 2009-2014 CADILLAC CTS-V

SUPERCHARGER SPRAY BAR SYSTEM 00-10171-XX

## INSTALLATION INSTRUCTIONS

### Wiring Diagram and Information

Now that your system is installed, you can begin wiring it. When wiring your nitrous system, double check all of your wiring connections. For a clean, professional install we recommend using heat shrink of all crimped connectors. This will protect the connection, and make the connection stronger between the wire and crimp-on connector.

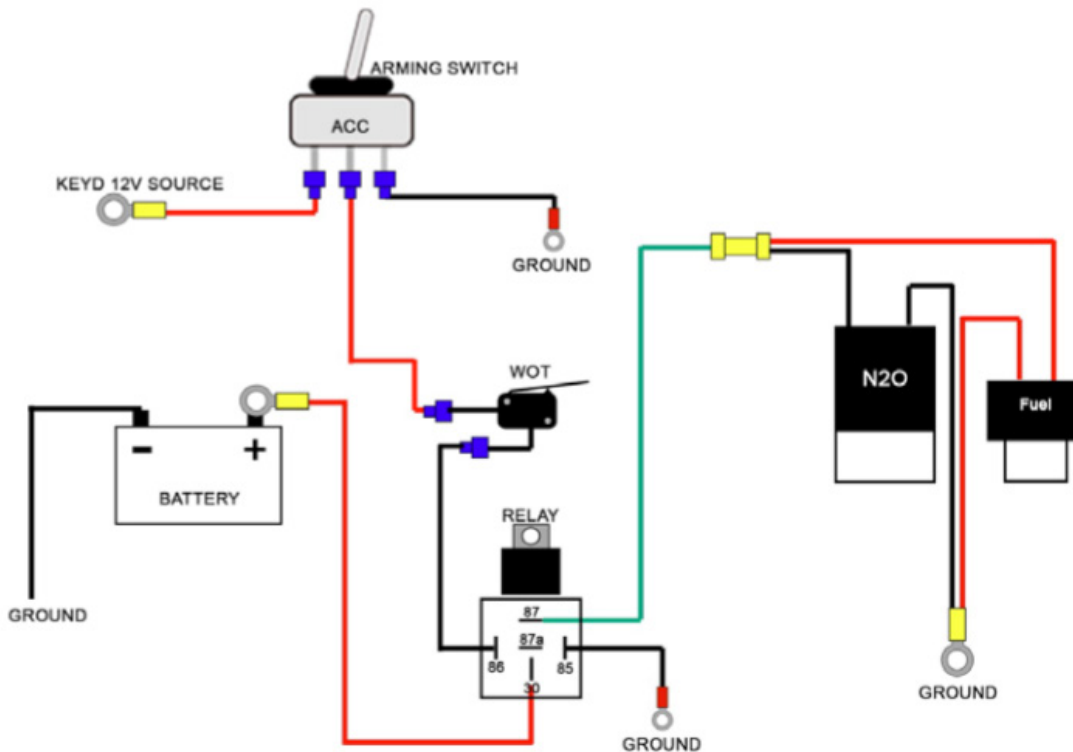

305 S. 28th street Waco, TX 76710 - TEL 254-848-4300

WWW.NITROUSOUTLET.COM

IMPORTANT- ALL APPROPRIATE SAFETY EQUIPMENT (GLOVES, TOOLS ETC.) MUST BE USED DURING THE INSTALLATION OF THIS PRODUCT(S).  
NITRO DAVE'S LLC ACCEPTS NO RESPONSIBILITY FOR INJURIES RESULTING IN THE INSTALLATION OF ANY PRODUCT(S). NITROUS OXIDE IS FOR OFF-ROAD USE ONLY.



# 2009-2014 CADILLAC CTS-V

## SUPERCHARGER SPRAY BAR SYSTEM 00-10171-XX

### INSTALLATION INSTRUCTIONS

#### Parts Included:

Billet Spraybar Spacer Plate  
Billet Intercooler Spacer  
LSA Supercharger Gasket  
LSA Intercooler Gasket  
17 x Supercharger Lid Bolts  
Jet Pack  
2 x Bracket Spacer  
2 x Solenoid Mounting Bolts  
Fuel Solenoid  
Fuel Solenoid Bracket  
Nitrous Solenoid  
Nitrous Solenoid Bracket  
1/4" x 6AN 90° Fitting  
1/8" x 4AN 45° Fitting  
1/8" x 4AN 90° Fitting  
1/8" x 4AN Straight Fitting  
4AN 90° Swivel Fitting  
LSA Hard Line Kit  
Fuel Feed Hard Line  
LSA Fuel Feed Hose (From Solenoid to Hard Lines)  
LSA Nitrous Feed Hose (From Solenoid to Hard Lines)  
192" 6AN Nitrous Feed Hose  
Standard Bottle Bracket  
WOT Switch  
Universal Solenoid Bracket  
Duckbill Toggle Switch  
Relay & Harness  
6ft. 18g Blue Wire  
6ft. 12g Red Wire

305 S. 28th street Waco, TX 76710 - TEL 254-848-4300

WWW.NITROUSOUTLET.COM

IMPORTANT- ALL APPROPRIATE SAFETY EQUIPMENT (GLOVES, TOOLS ETC.) MUST BE USED DURING THE INSTALLATION OF THIS PRODUCT(S).  
NITRO DAVE'S LLC ACCEPTS NO RESPONSIBILITY FOR INJURIES RESULTING IN THE INSTALLATION OF ANY PRODUCT(S). NITROUS OXIDE IS FOR OFF-ROAD USE ONLY.