

Installation Instructions

I - Sheet Number VV33 Rev.A



Ventvisor® Deflector

**For proper installation and best possible fit, please read all instructions BEFORE you begin.
For technical assistance or to obtain missing parts, please call Customer Relations at 1-800-241-7219.**

Important Safety Information



- CAUTION - Before driving, ensure that the vent visor is properly secured to vehicle.
- Do not use automatic "brush-style" car washes.
- Do not use cleaning solvents of any kind.
- Periodically check all components for tightness.

Contents - 2 Piece Set **NOTE:** Actual product may vary from illustration.



Front Driver Side Visor



Front Passenger Side Visor



Alcohol Pad x2

Contents - 4 Piece Set



Front Driver Side Visor



Front Passenger Side Visor



Rear Driver Side Visor



Rear Passenger Side Visor



Alcohol Pad x4

Tools Required



Car Wash Supplies

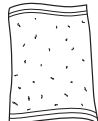

Clean Towel

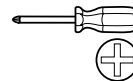

Screwdriver

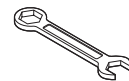

Wrench

Preparation Before Painting / Installation

- A trial fit is recommended to ensure proper positioning and fit.
- Check fit of parts before painting as we will not accept the return of modified or painted parts.
- Wash and dry your vehicle to remove any debris and/or dirt from the installation area.

Installation Steps **NOTE:** Actual application may vary slightly from illustrations.

Open door and lower window.

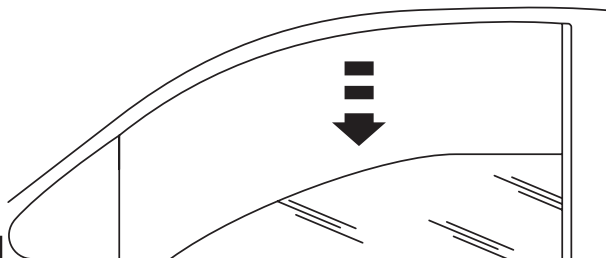

1



2

Locate fasteners that attach side mirror to door. Loosen (but do not remove) the fasteners to create the necessary gap behind mirror cap to install front visor flange.

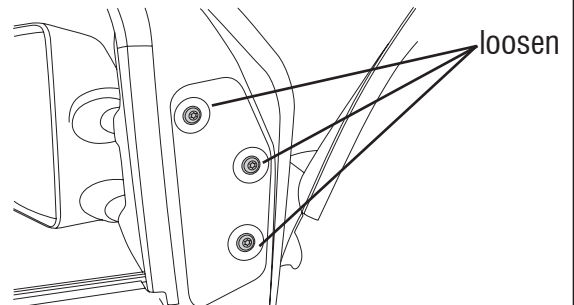

Installation Steps

NOTE: Actual application may vary slightly from illustrations.

Alcohol Pad

Clean the painted metal door frame around the front window with an alcohol pad.

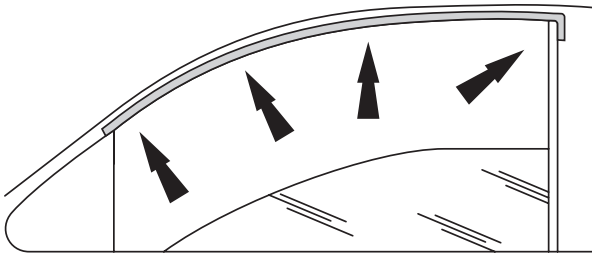

3

Remove tape liner from front & rear flange. Peel back 2" (5 cm) of tape line from each end of top flange.

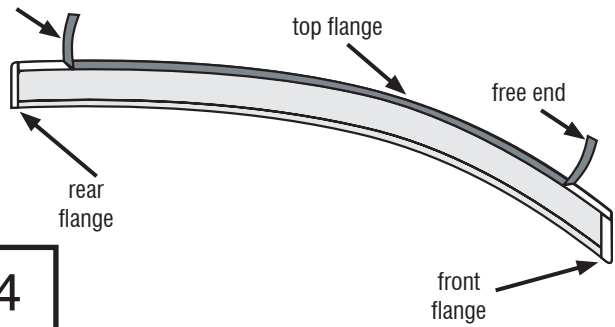

4

Align the visor on the metal door frame.

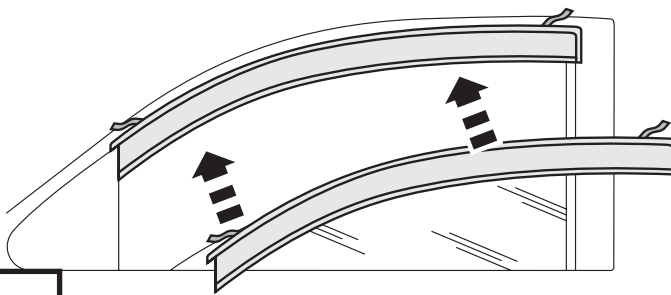

5

Position the front visor flange in the gap under the mirror cap created in Step 2.

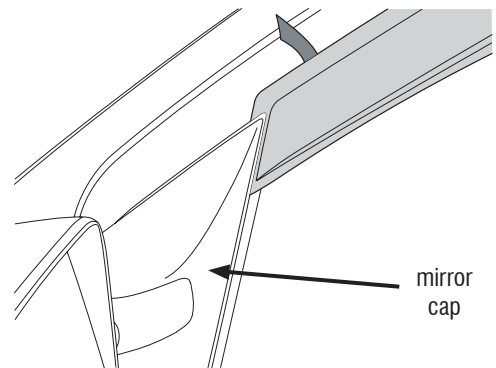

6

Gently press along exposed area of tape to secure in place.

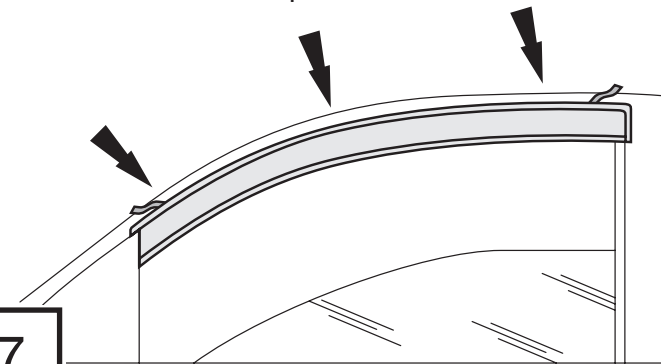

7

With the visor in its final position, remove remaining tape liner by pulling on free ends.

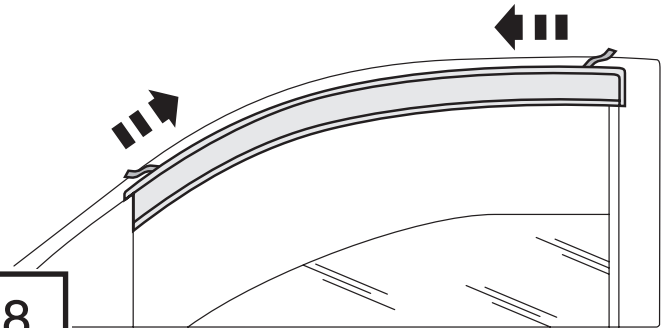

8

Press firmly along tape flanges to ensure tape adhesion.

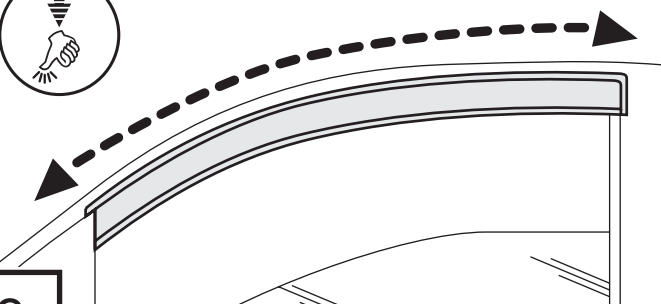

9

Re-tighten mirror mounting fasteners. To avoid damaging the mirror, do not overtighten the mirror mounting bolts.

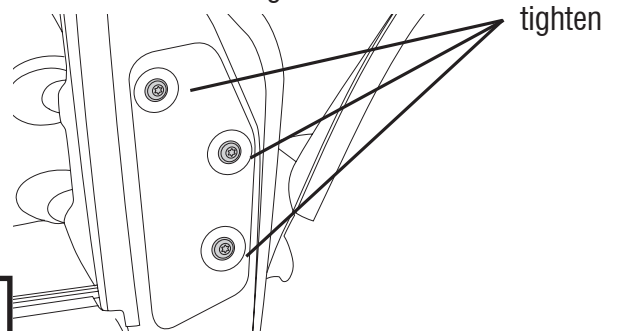

10

Installation Steps

NOTE: Actual application may vary slightly from illustrations.

Repeat **Steps 1 - 10** for passenger side front visor

4 Piece Set

Clean the painted metal door frame around the rear window with an alcohol pad.

Alcohol Pad

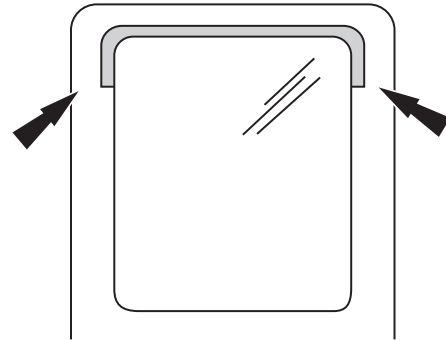

11

Remove tape liner from front & rear flange. Peel back 2" (5 cm) of tape line from each end of top flange.

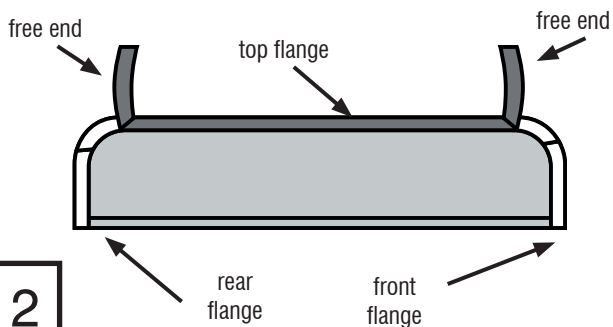

12

Align the visor on the metal door frame, remove remaining tape liners, and apply pressure to secure in place.

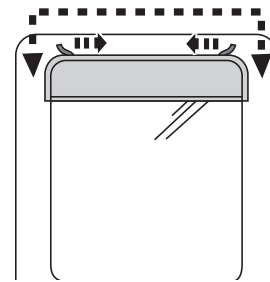

13

Repeat **Steps 11 - 13** for passenger side rear visor

Care and Cleaning

- Wash only with mild soap & dry with a clean cloth.

Congratulations!

You have purchased one of the many quality Auto Ventshade™ branded products offered by Lund International, Inc. We take the utmost pride in our products and want you to enjoy years of satisfaction from your investment. We have made every effort to ensure that your product is top quality in terms of fit, durability, finish and ease of installation.



AUTO VENTSHADE™

Lund International, Ventshade Accessories Division

655 Raco Drive, Lawrenceville, GA 30045

800-241-7219 • Fax 770-339-5839 • Visit us at lundinternational.com



© 2005 Lund International, Inc. All rights reserved.

Auto Ventshade™, the Auto Ventshade™ logo and the AVS™ logo are trademarks of Lund International, Inc.





Ventvisor® Deflector

Pour obtenir une installation correcte et le meilleur ajustement possible, lire toutes les instructions AVANT de commencer.
 Pour toute assistance technique ou obtention de pièces manquantes, appeler le service des relations avec la clientèle au 1-800-241-7219.

Informations importantes concernant la sécurité



- ATTENTION – Avant de conduire, s'assurer que la visière est solidement assujettie sur le véhicule.
- Ne pas utiliser les stations de lavage de voitures à brosses.
- Ne pas utiliser de solvants.
- Vérifier régulièrement le serrage des composants.

Contenu - Ensemble 2 pièces

NOTE: Le produit réel peut changer de l'illustration.



Visière avant côté conducteur



Visière avant côté passager



Tampons à l'alcool (2)

Contenu - Ensemble 4 pièces



Visière avant côté conducteur



Visière avant côté passager



Visière arrière côté conducteur



Visière arrière côté passager



Tampons à l'alcool (4)

Outils nécessaires



Fournitures pour lavage de voiture



Serviette propre

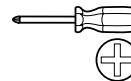

Tournevis

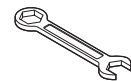

Clé

Préparation pour la peinture/l'installation

- Il est recommandé de procéder à un essai pour s'assurer que le positionnement et l'ajustement sont corrects.
- Vérifier l'ajustement des pièces avant peinture, car nous n'acceptons pas le retour de pièces modifiées ou peintes.
- Laver les glissières de glaces de la portière du véhicule pour éliminer toute poussière et tous débris.
- Sécher les glissières avec une serviette propre.

Étapes d'installation

REMARQUE : La méthode d'application peut être légèrement différente de celle représentée par les illustrations.

Ouvrir la portière et abaisser la glace.



Localiser les fixations qui retiennent le rétroviseur latéral à la portière. Desserrer (sans les retirer) les fixations afin d'obtenir un écartement suffisant, derrière le couvercle du rétroviseur, pour pouvoir installer le rebord de visière avant.

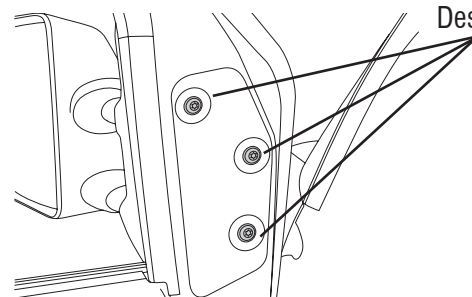

Desserrer

1

2

Étapes d'installation

REMARQUE : La méthode d'application peut être légèrement différente de celle représentée par les illustrations.

Alcohol Pad

Nettoyer avec un tampon à l'alcool l'encadrement peint métallique de la portière autour de la glace avant.

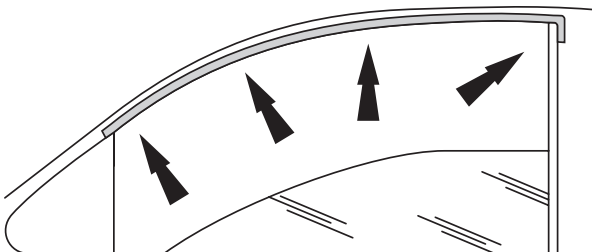

3

Retirer la protection d'adhésif des rebords avant et arrière. Décoller environ 5 cm (2 po) de protection d'adhésif à chaque extrémité du rebord supérieur.

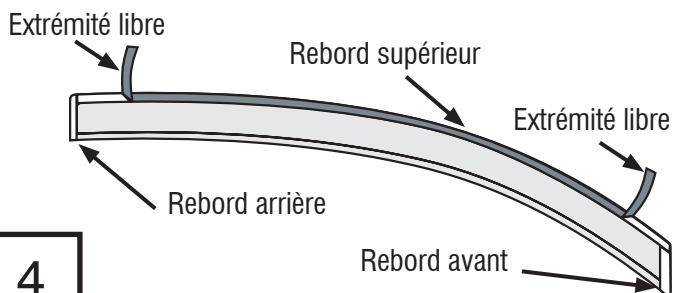

4

Aligner la visière et l'encadrement métallique de la portière.

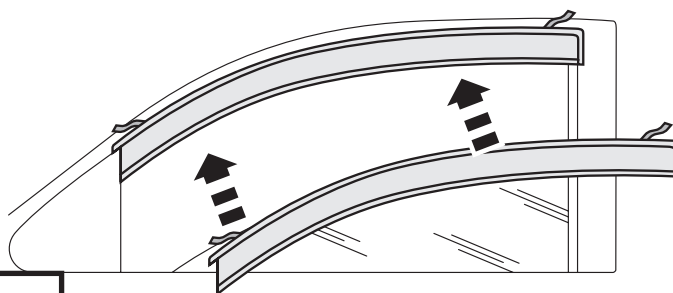

5

Positionner le rebord de visière avant dans l'écartement créé sous le couvercle du rétroviseur à l'étape 2.

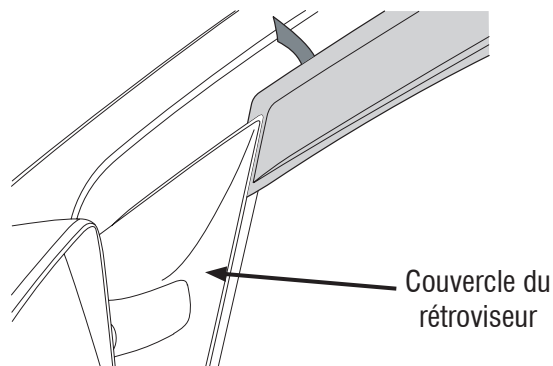

6

Appuyer doucement tout le long de la partie exposée du ruban adhésif pour bien le fixer en place.

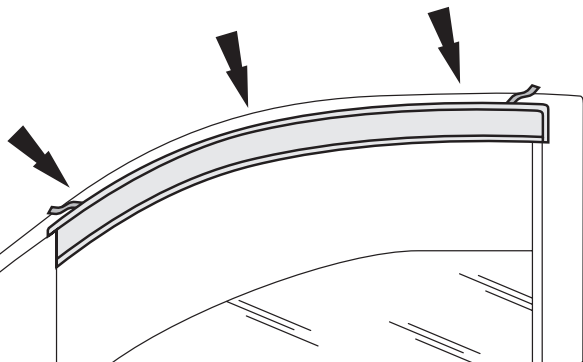

7

Une fois la visière en position finale, retirer le reste de la protection d'adhésif en tirant sur les extrémités libres.

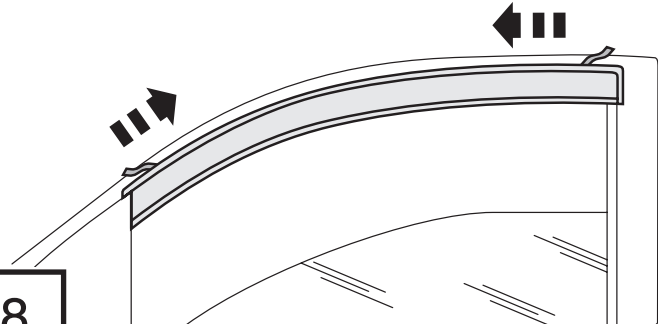

8

Appuyer fermement tout le long des rebords du ruban adhésif pour en assurer une bonne adhésion.

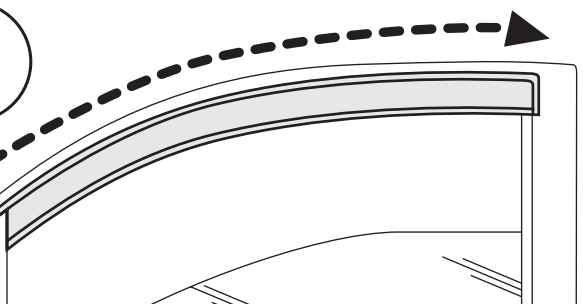

9

Resserrer les fixations de montage du rétroviseur. Ne pas trop serrer les boulons de montage du rétroviseur pour éviter d'endommager ce dernier.

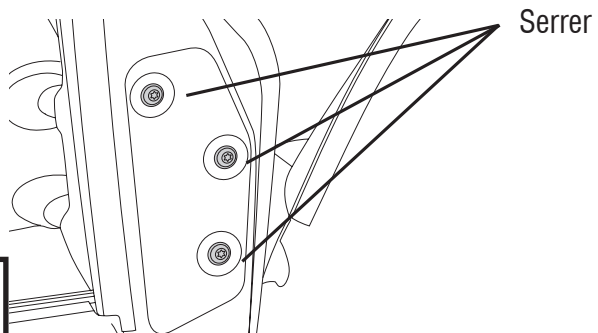

10

Étapes d'installation

REMARQUE : La méthode d'application peut être légèrement différente de celle représentée par les illustrations.

Répéter les **étapes 1 à 10** pour la visière avant côté passager.

Ensemble 4 pièces

Alcohol Pad

Nettoyer avec un tampon à l'alcool l'encadrement peint métallique de la portière autour de la glace arrière.

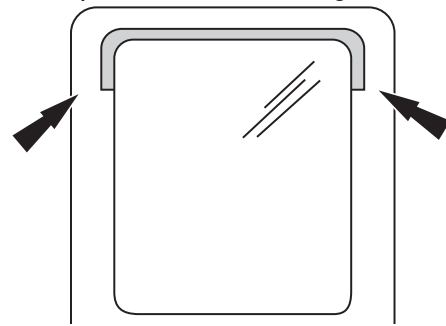

11

Retirer la protection d'adhésif des rebords avant et arrière. Décoller environ 5 cm (2 po) de protection d'adhésif à chaque extrémité du rebord supérieur.

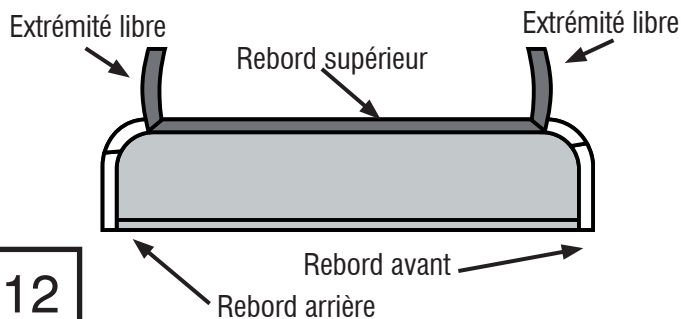

12

Aligner la visière et l'encadrement métallique de la portière, retirer le reste des protections d'adhésif et appuyer pour bien fixer le tout en place.

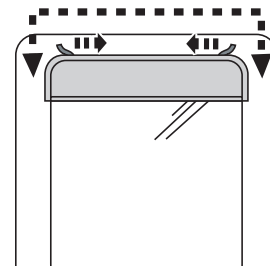

13

Répéter les **étapes 11 à 13** pour la visière arrière côté passager.

Entretien et nettoyage

- Laver exclusivement avec de l'eau savonneuse et sécher avec un chiffon propre.

Félicitations !

Vous avez acheté l'un des nombreux produits de qualité Auto Ventshade™ fabriqués par Lund International, Inc. Nous sommes extrêmement fiers de nos produits et souhaitons que vous tiriez des années de satisfaction de votre investissement. Nous avons pris toutes les mesures nécessaires pour assurer que ce produit est d'une qualité supérieure en ce qui concerne l'ajustement, la durabilité, la finition et la facilité d'installation.



AUTO VENTSHADE™

Lund International, Ventshade Accessories Division

655 Raco Drive, Lawrenceville, GA 30045, USA

800-241-7219 • Fax 770-339-5839 • Visitez notre site lundinternational.com



© 2005 Lund International, Inc. Tous droits réservés.
Auto Ventshade™, le logo Auto Ventshade™ et le logo AVS™ sont des marques déposées de Lund International, Inc.





Ventvisor® Deflector

Para una instalación adecuada y el mejor ajuste posible, lea todas las instrucciones ANTES de comenzar. Si desea recibir asistencia técnica u obtener piezas faltantes, llame al Servicio al cliente al 1-800-241-7219.

Información importante de seguridad



- PRECAUCIÓN - Antes de conducir, asegúrese de que la visera esté correctamente anclada al vehículo.
- No utilice servicios automáticos de limpieza de vehículos que utilizan cepillos.
- No utilice limpiadores al solvente de ningún tipo.
- Compruebe periódicamente que todos los componentes estén ajustados.

Contenido - Juego de dos piezas

NOTA: El producto real puede variar de la ilustración.



Visera delantera del conductor



Visera delantera del acompañante



Paños esterilizados x 2

Contenido - Juego de cuatro piezas



Visera delantera del conductor



Visera delantera del acompañante



Visera trasera del conductor



Visera trasera del acompañante



Paños esterilizados x 4

Herramientas necesarias



Equipo de limpieza de vehículos



Toalla limpia

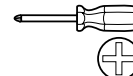

Destornillador

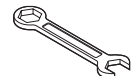

Llave

Preparación antes de pintar o instalar

- Se recomienda realizar un ajuste de prueba para asegurar el posicionamiento y ajuste correctos.
- Compruebe que las piezas se ajusten correctamente antes de pintarlas, ya que no aceptaremos la devolución de piezas modificadas o pintadas.
- Lave los canales de la ventanilla del vehículo para quitar los desechos y la suciedad.
- Seque los canales de la ventanilla con una toalla limpia.

Pasos de instalación

AVISO: La colocación real puede variar con respecto a las ilustraciones.

Abra la puerta y baje la ventanilla.



Ubique los sujetadores que unen el espejo lateral a la puerta. Afloje (pero no quite) los sujetadores hasta crear el espacio necesario detrás de la cubierta del espejo para instalar el reborde frontal de la visera.

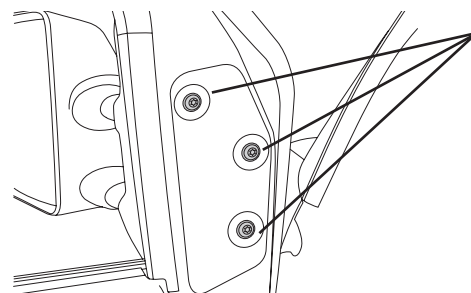

afloje

1

2

Pasos de instalación

AVISO: La colocación real puede variar con respecto a las ilustraciones.

Alcohol
Pad

Limpie el marco de metal pintado de la puerta situado alrededor de la ventanilla delantera con un paño esterilizado.

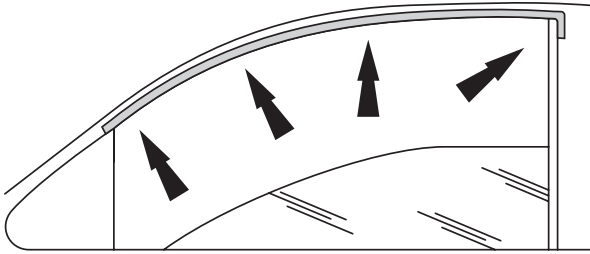

3

Quite la cinta protectora del reborde frontal y trasero. Retire 2 pulgs. (5 cm) de cinta protectora de cada uno de los extremos del reborde superior.

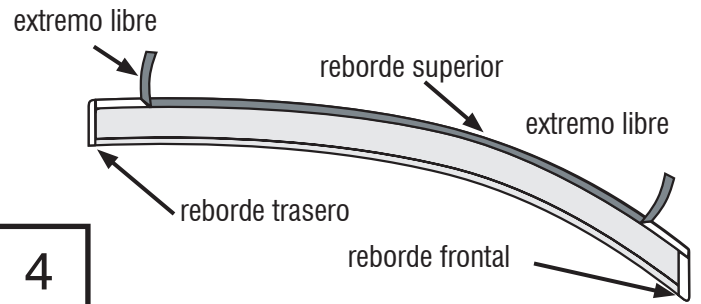

4

Alinee la visera con el marco de metal de la puerta.

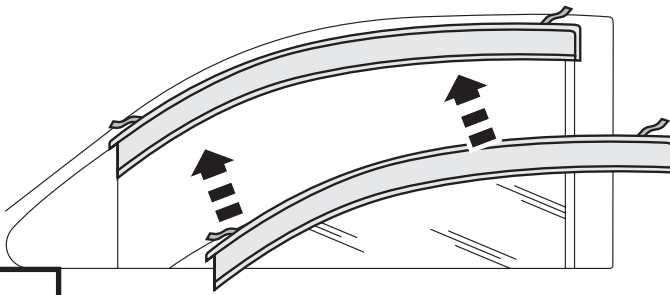

5

Coloque el rebordo frontal de la visera en el espacio debajo de la cubierta del espejo que creó en el **paso 2**.

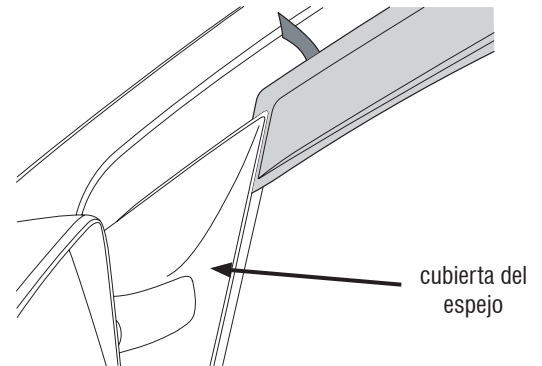

6

Presione suavemente el área expuesta de la cinta para fijarla en su lugar.

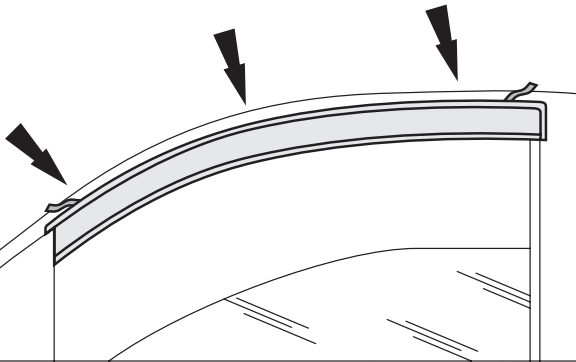

7

Una vez que la visera se encuentra en su posición definitiva, quite la cinta protectora restante tirando de los extremos libres.

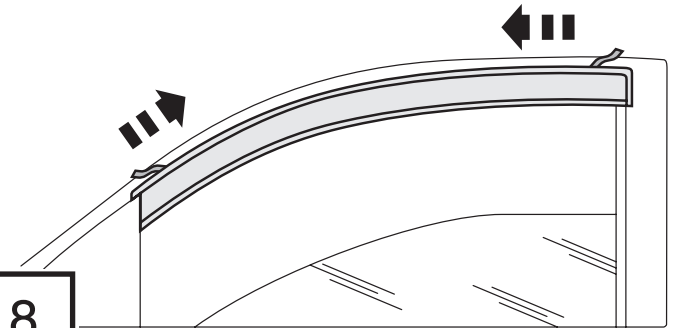

8

Presione firmemente sobre los rebordes para asegurarse de que la cinta quede adherida.

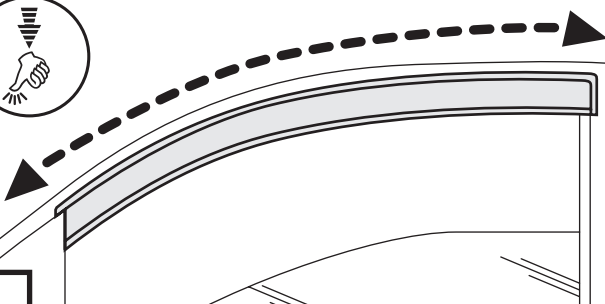

9

Vuelva a ajustar los sujetadores de montaje del espejo. Para evitar que se dañe el espejo, no ajuste demasiado los pernos de montaje del espejo.

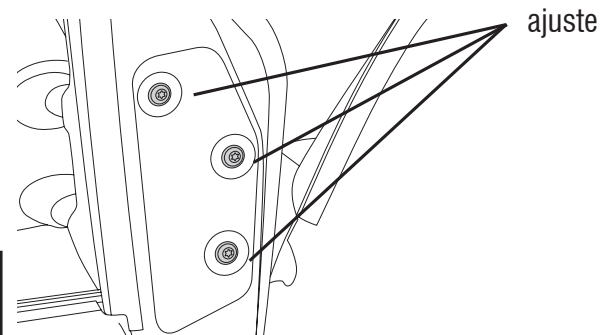

10

Pasos de instalación

AVISO: La colocación real puede variar con respecto a las ilustraciones.

Repita los **pasos 1 a 10** para la visera del acompañante

Juego de cuatro piezas

Alcohol Pad

Limpie el marco de metal pintado de la puerta situado alrededor de la ventanilla trasera con un paño esterilizado.

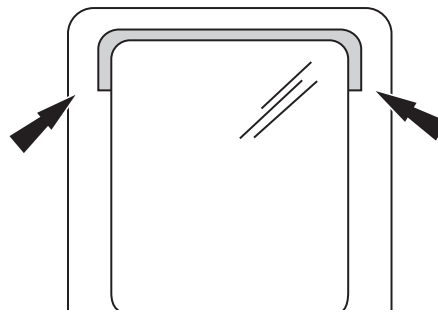

11

Quite la cinta protectora del reborde frontal y trasero. Retire 2 pulgs. (5 cm) de cinta protectora de cada uno de los extremos del reborde superior.

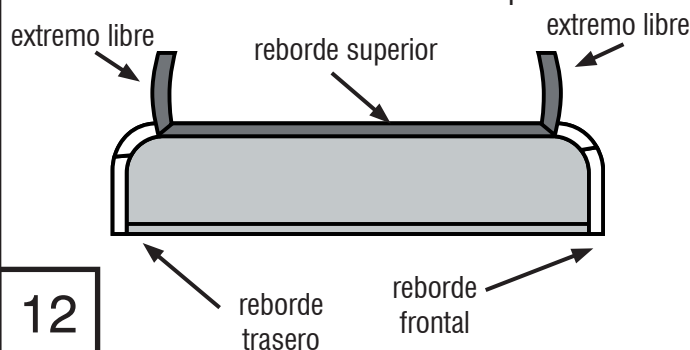

12

Alinee la visera con el marco de metal de la puerta, quite la cinta protectora restante y presione para fijarla en su lugar.

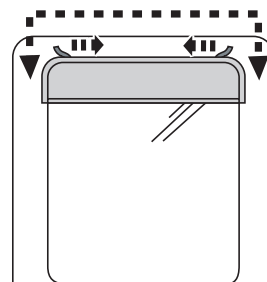

13

Repita los **pasos 11 a 13** para la visera trasera del acompañante

Cuidado y limpieza

- Limpie solamente con agua jabonosa tibia y seque con un paño limpio.

Felicidades

Usted ha comprado uno de los tantos artículos de calidad de Auto Ventshade™ ofrecidos por Lund International, Inc. Nuestros productos son nuestro mayor orgullo. Deseamos que disfrute de años de satisfacción con su inversión. Hemos realizado todos los esfuerzos para asegurarnos de que su producto sea de la mejor calidad en cuanto a ajuste, durabilidad, acabado y facilidad de instalación.



AUTO VENTSHADE™

Lund International, Ventshade Accessories Division

655 Raco Drive, Lawrenceville, GA 30045

800-241-7219 • Fax 770-339-5839 • Visite nuestro sitio Web: lundinternational.com



© 2005 Lund International, Inc. Todos los derechos reservados.
Auto Ventshade™, el logo de Auto Ventshade™ y el logo de AVS™ son marcas comerciales de Lund International, Inc.

