

**INSTALLATION INSTRUCTIONS  
FOR PART #210  
STAGE 2 BOOST COOLER®  
WATER-METHANOL INJECTION  
SYSTEMS**



**BOOST COOLER™**

---

---

# Install Notes

---

## CONTENTS

---

Kit Contents	3
Installation – Mechanical	5
Installation – Electrical	9
Testing the System	14
Initial Tuning	11
Tuning Quick Reference/Maintenance	15
Disclaimer/Warranty	16

Have a question?

Online: [www.snowperformance.net](http://www.snowperformance.net)

Tech Email: [tech@snowperformance.net](mailto:tech@snowperformance.net)

 **CAUTION**

You must completely read through these instructions before installing and operating this product. Failure to do so can result in damage to this product and the vehicle.

---

---

**Distributor/Dealer Warranty:**

All customers/dealers must deal directly with Snow performance to receive warranty. No warranty will be issued through a distributor for any reason.

**Return Policy:**

All returns must be called in for RMA #. Snow Performance will not take used kits or parts for refund. If you are returning an unused kit there is a 15% restocking fee minus shipping/handling. All returns must be made within 90 days of purchase date. No exceptions.

**LIMITATION OF LIABILITY:**

REPAIR OR REPLACEMENT OF A DEFECTIVE PRODUCT IS THE ORIGINAL RETAIL PURCHASER'S EXCLUSIVE REMEDY UNDER THIS WARRANTY. DAMAGE OR INJURY TO THE ORIGINAL RETAIL PURCHASER, TO HIS OR HER VEHICLE, CARGO, OR PROPERTY, AND/OR TO ANY OTHER PERSON OR PROPERTY IS NOT COVERED BY THIS WARRANTY. THIS WARRANTY IS EXPRESSLY MADE IN LIEU OF ANY AND ALL OTHER EXPRESS WARRANTIES, WHETHER ORAL OR WRITTEN. SNOW'S SOLE LIABILITY IS LIMITED TO THE REMEDY SET FORTH ABOVE. IN NO EVENT WILL SNOW BE LIABLE FOR ANY DIRECT, INDIRECT, CONSEQUENTIAL, INCIDENTAL, SPECIAL, EXEMPLARY, OR PUNITIVE DAMAGES OR FOR ANY OTHER DAMAGES OF ANY KIND OR NATURE (INCLUDING, BUT NOT LIMITED TO, LOST PROFITS OR LOST SALES). SOME STATES DO NOT ALLOW THE EXCLUSION OR LIMITATION OF INCIDENTAL OR CONSEQUENTIAL DAMAGES, SO THE ABOVE LIMITATIONS MAY NOT APPLY TO YOU.

**Contact Us:**Phone

Tech Support	(719) 633-3811
Fax	(719) 633-3496
Tech Support Line (Toll Free)	(866) 365-2762

Web

<http://www.snowperformance.net>

Email

[customerservice@snowperformance.net](mailto:customerservice@snowperformance.net)  
[tech@snowperformance.net](mailto:tech@snowperformance.net)

Mail

Snow Performance, Inc  
1017-A East Highway 24  
Woodland Park, CO 80863

**Parts**

- 300 PSI UHO (Ultra High Output) Pump
- 3 Qt Reservoir
- 10' High Temp Nylon Tubing
- 3' Black Wire Loom
- 18" 1/8" Silicone Tubing
- 1 Level Switch
- Gauge Pod Assembly

**Electrical Packet**

- 2 Blue Butt Connectors
- 3 Large Eyehooks
- 2 Wire Splice
- VC-50 Controller
- 10 Tie Wraps
- 1 Vacuum "T"
- 1 Running S Decal

**Required Tools:**

- Electric Drill
- 11/32" Drill Bit
- 13/16" Drill Bit
- Utility Knife
- Screw Driver
- 5/16, 7/16 Open End Wrench
- 1/8" -27 NPT Tap

**Mechanical Packet**

- 1 Nozzle Holder/Check Valve Combo
- 1 Reservoir Fitting 3/8" NPT to 1/4" tube
- 8 #8x1&1/2" Screws
- 8 #8 Washers
- 1 E-6000® (GOOP)

**Nozzles**

- 60ML/MN (#1)
- 100ML/MN (#2)
- 175ML/MN (#3)
- 225ML/MN (#4)
- 375ML/MN (#5)
- 625ML/MN (#6)

**Average Install Time:  
4-6 Hours**

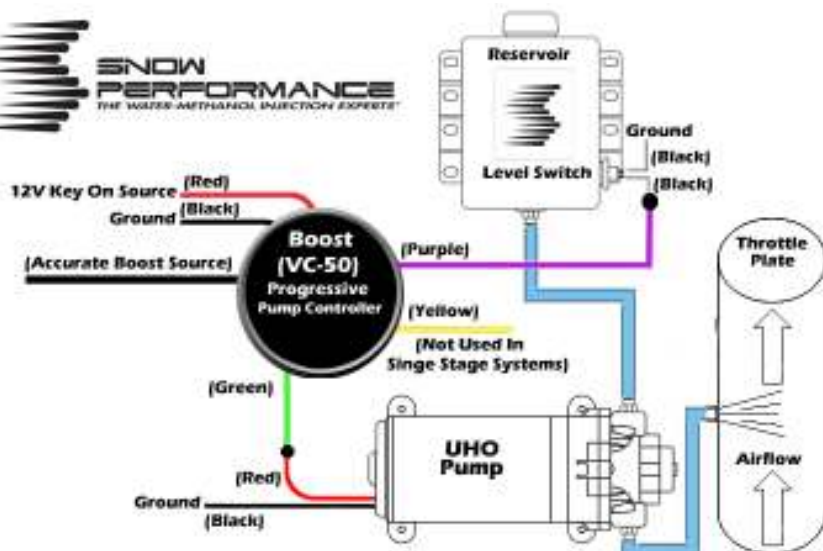

**Stage 2 Boost Cooler® (Part# 210)**

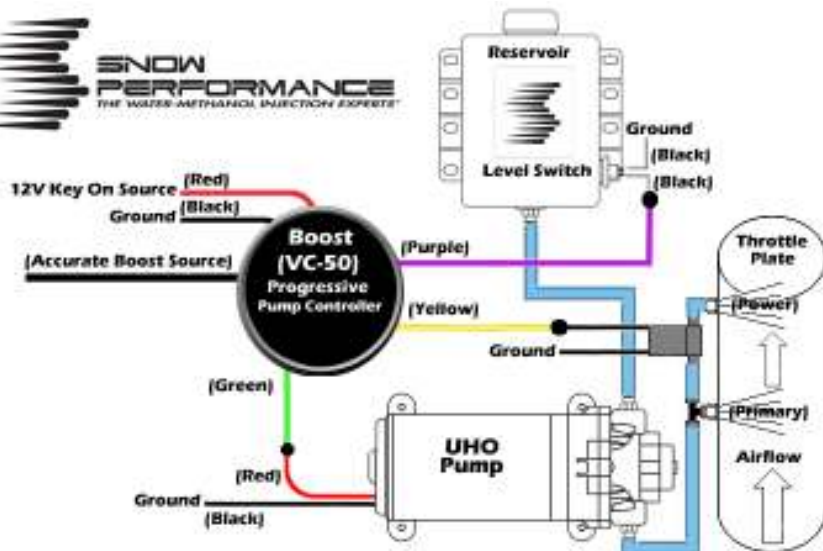

**Stage 2 Boost Cooler® (Part# 210) Dual Stage**

**Note: For dual stage functionality a Solenoid Part# 40060 & Dual Nozzle Upgrade Part# 40040 will need to be purchased separately.**

**Warranty Policy:**

Snow Performance, Inc. warrants that the Product shall conform to and perform in accordance with published technical specifications and shall be free of defects in materials and workmanship for 1-year providing:

1. You are the original purchaser and provide proof of purchase.
2. The system was purchased from a Snow Performance Authorized Dealer at MRP pricing set by Snow Performance.\*

\*No warranty will be offered for any Snow Performance products if purchased below MRP.

3. For Lifetime warranty, the Warranty Card that came with system (not applicable to separate parts purchases) is returned to Snow within 45-days of purchase and Boost Juice® injection fluid is used exclusively.\*

\* Boost Juice® usage evidenced by invoices/ receipts.

4. An RMA # has been attained and is displayed on package containing returned part.
5. Parts Warranty ~ 90 day warranty on parts purchased separately if used in conjunction with a Snow System. No warranty implied if used with a non-Snow part/system. Subject to Snow's inspection of the product, Snow will remedy defects in materials and/or workmanship by repairing or replacing, at Snow's option, the defective product without charge for parts or labor, subject to the limitations and exclusions described in this warranty.

This warranty does not cover problems caused by normal wear and tear including aesthetic oxidation of surfaces, accidents, unlawful vehicle operation, or modifications or repairs to product not performed or authorized by Snow. This includes any product that is disassembled or taken apart for any reason.

In addition, this warranty does not cover problems resulting from conditions beyond Snow's control including, but not limited to, theft, misuse, overloading, or failure to assemble, mount or use the product in accordance with Snow's written instructions or guidelines included with the product or made available to the original retail purchaser. In the event of failure, Snow will repair or replace the part at Snow's sole discretion. Failures resulting from misapplication or misuse of the Product, failure to adhere to any specifications or instructions, or failure resulting from neglect, abuse, accidents, or act of nature are not covered under this warranty.

Warranty service may be obtained by calling 719-633-3811, getting an RMA (Return Merchandise Authorization), delivering the part to Snow along with proof of purchase. Customer agrees to insure the Product or assume the risk of loss or damage in transit, to prepay shipping charges to Snow, and to use the original shipping container or equivalent. Shipping for Warranty replacement parts shipped outside the continental US will be charged to customer.

**Non-Warranty Repair/Retest**

Products returned due to damage or misuse and Products retested with no problem found are subject to repair/retest charges. Product will be returned to customer at customer's expense. A credit card number must be provided in order to obtain an RMA (Return Merchandise Authorization) number prior to returning Product.

---

---

# Maintenance

Remove nozzle(s) and clean screen filters once per year using a calcium removing formula such as CLR®

The Boost Cooler® has been designed to operate with high concentrations of methanol. Oil or other additives are not required for system lubrication, and can cause damage to the system.

Contaminants in the fluid such as dirt can damage the system. Ensure that dirt and debris do not fall into the tank.

Do not use Teflon tape or paste to seal connections. These sealers are not as effective as the Goop sealant provided and can break down over time, clogging components.

## Disclaimer

Do not use this product until you have carefully read the following agreement. This sets forth the terms and conditions for the use of this product. The installation of this product indicates that the BUYER has read and understands this agreement and accepts its terms and conditions. Performance products by their nature are designed to increase horsepower and performance not engineered in the original vehicle and the increased stress could result in damage to related systems. This is a high performance product – use at your own risk. Snow Performance Inc., Its agents, employees or owners shall not be under any liability whether in contract or otherwise whether or not resulting from our negligence or contents of information supplied for any damage or loss resulting from such information. The BUYER is responsible to fully understand the capability and limitations of his/her vehicle according to manufacturer specifications and agrees to hold the SELLER harmless from any damage resulting from failure to adhere to such specifications. The SELLER disclaims any warranty and expressly disclaims any liability for personal injury or damages. The BUYER acknowledges and agrees that the disclaimer of any liability for personal injury is a material term for this agreement and the BUYER agrees to indemnify the SELLER and to hold the SELLER harmless from any claim related to the item of the equipment purchased. Under no circumstances will the SELLER be liable for any damages or expenses by reason of use or sale of any such equipment. The BUYER is responsible to obey all applicable federal, state, and local laws, statutes, and ordinances when operating his/her vehicle, and the BUYER agrees to hold SELLER harmless from any violation thereof. The SELLER assumes no liability regarding the improper installation or misapplication of its products. It is the installer's responsibility to check for proper installation and if in doubt, contact the manufacturer.

Notes: The contents of this document are subject to change without prior notice. No part of or this entire document may be reproduced in any form without prior written permission of Snow Performance, Inc under the copyright except for private use. The names, addresses and telephone numbers mentioned are current as of December 8, 2014. Note that this information is subject to change. Please refer to [www.snowperformance.net](http://www.snowperformance.net) for current information.

---

---

# Installation- Mechanical

## Step 1 Level Switch Install

- Locate desired level switch mounting position. Suggest placement is 1/3 of max reservoir height.
- Using a stepped drill bit, Drill a 13/16th-inch hole approximately 1/5th from the bottom of the reservoir. Hole must be free of nicks or shavings for proper sealing. Clear any debris from the inside of the reservoir.
- Remove rubber seal from level switch. Insert seal into reservoir until fully seated.
- Lubricate exterior of level switch with water and insert into seal until fully seated. Position level switch so GT symbol is at six o'clock position.
- With fluid level above level switch, float should be angled up. With fluid level below level switch, float should be in horizontal position.



## Step 2 Reservoir Install

- Install 3/8" NPT to 1/4" tube reservoir fitting using E6000® sealant in the bottom of the reservoir.
- After allowing the thread sealant to dry, fill reservoir with about 1-quart of water and check for leaks around reservoir fitting and level switch. If leak occurs use E6000® sealant.
- Install the 3qt. reservoir with four (4) #8x1&1/2" screws and four (4) #8 washers in desired mounting location.

**\*\*The reservoir should be installed above the pump, but below the nozzle. This keeps the pump primed and avoids fluid leaking into nozzle when not in use\*\***

**\*\*Use caution when installing screws, do not damage any wiring or fluid lines that may be hidden\*\***

### \*\*\*Caution\*\*\*

To avoid gravity feeding of fluid with rear mount reservoirs, it is essential to use a solenoid upgrade (Part #40060). **Do not operate your rear mount reservoir equipped vehicle without a solenoid installed.**

## Installation- Mechanical (cont'd)

### Step 3 Pump Install

- Position the fluid pump so that the inlet is positioned at or below the lowest point of the reservoir, and within two feet of the reservoir. (Pump can be installed in any orientation).

**\*\*Arrows on the pump inlet and outlet indicate the direction of fluid flow\*\***

- Install the fluid pump with four (4) #8x1&1/2" screws and four (4) #8 washers in desired mounting location.
- Using Supplied large eyehook connect pump black wire to chassis ground.
- Remove the rubber plugs from the push-locks by first pushing the plug toward the pump, hold the grey collar against the pump, and gently pull the plug from the fitting.

**\*\*Pulling against the push-lock fittings with excessive force may cause damage to the fittings\*\***

- Fit the high temp nylon tubing between the reservoir fitting and the pump inlet, ensuring there are no kinks in the line and there is no stress on the push-lock fittings.

**\*\*\*Kinked tubing and stressed fittings may cause fluid leaks\*\*\***

- Cut tubing straight and remove burrs so that the fluid line properly seals against the internal o-rings.
- Insert tubing into the push-locks until fully seated, and pull lightly against push-locks to ensure proper installation.

### \*\*\*Caution\*\*\*

Pump must be shielded from road debris and tire wash. Failure to do so will result in pump failure.

## Testing the System

### Step 1 Priming The System

**\*\*Before operating the system, it is recommended that the lines are first primed with fluid\*\***

- Fill reservoir with water
- Remove the nozzle from the intake tube.
- With the nozzle temporarily placed inside an empty container, purge the system by pushing the "prime" button (left hand button) on the controller until fluid flows consistently through the nozzle.

**\*\*If pump goes on and fluid level doesn't go down, there is an obstruction in the tube or nozzle.\*\***



**\*\*If the pump fails to activate, check power and ground wiring\*\***

## Tuning Quick Reference

The power potential of the system is realized through increased boost and/or timing. The large gains on octane and cooling provided by the system make this possible, even on standard pump fuel. The Boost Cooler® adds an alternate fuel source as well as significantly cools combustion. With the Boost Cooler®, one does not need to cool combustion with overly rich air/fuel ratios. To minimize combustion quench, you should start with an air to fuel ratio of 12.0-12.5:1. Injecting water/methanol lower than 3300-3500 RPM could result in combustion quench. All vehicles are different. If the engine bogs or loses power, then it is coming on too early, the quantity is too much, or there is not enough methanol in the mixture (50/50 water/methanol recommended).



# Other Controller Functions

## Low Level Alert

- When the fluid in the reservoir is running low the border of the graph for injection will blink yellow alerting the user to fill the water-methanol reservoir.

## Fail Safe Alerts

## Clogged Line

- In the event of a clogged line the psi reading on the main screen will turn to stars and begin flashing. If this occurs, fix the problem and press the middle red button to clear the code.

## Broken Line

- In the event of a broken line the psi reading on the main screen will turn to stars and begin flashing. If this occurs, fix the problem and press the middle red button to clear the code.

## Solenoid Not Engaging (Dual Stage Systems Only)

- In the event of a solenoid not opening to engage a second stage of water-methanol the psi reading on the main screen will turn to stars and begin flashing. If this occurs, fix the problem and press the middle red button to clear the code.



Mounting the pump inlet at or below the reservoir fitting will ensure the pump is primed with fluid prior to use.

# Installation- Mechanical (cont'd)

## Step 4 Nozzle Selection

### Nozzle Identification Chart:

Nozzle Number	Nozzle Size
1	60 ml/min
2	100 ml/min
3	175 ml/min

Nozzle Number	Nozzle Size
4	225 ml/min
5	375 ml/min
6	625 ml/min

Nozzle sizing is determined by horsepower (which approximates the engine airflow) and boost (which approximates intake charge heat).

### Recommended starting points:

250 - 350 RWHP:	175 ml/min nozzle.
350 - 475 RWHP:	375 ml/min nozzle
475 - 600 RWHP	625 ml/min nozzle

- Install the desired nozzle into the nozzle holder using E6000® sealant around nozzle threads.



Seal the nozzle into the nozzle holder using the included E6000® sealant. Using a sealant that is not permanent will allow for nozzle changes during tuning. Simply remove the nozzle, clean the threads, and reinstall using sealant.

**\*\*The end of the nozzle with the fine mesh screen should be inserted into the nozzle holder\*\***



Correct



Incorrect

- Using a 5/16" open end wrench and a 7/16" open end wrench, tighten the nozzle 1/2 turn past finger tight.

**\*\*\*Teflon sealants are not compatible with water/methanol, and should not be used with the install of your Snow Performance Boost Cooler\*\*\***

### \*\*\*Caution\*\*\*

If nozzle is mounted lower than the reservoir or beyond the throttle body, a Solenoid (Part #40060) must be used to prevent gravity and/or vacuum siphoning.

## Installation- Mechanical (cont'd)

### Step 5 Nozzle Mounting

- Drill and tap the intake tube with a 11/32" drill bit and a 1/8"-27 NPT thread tap in desired nozzle mounting location.

**\*\*\*To prevent debris from entering the engine, remove the intake tube from the vehicle prior to drilling\*\*\***

**Note:** If no metal piping is available to tap for nozzle placement a Nozzle Mount Adapter (Part #40110) may be used to secure nozzle in plastic/rubber air Inlet pipe.



**TECH TIP** Install the nozzle within 6-inches of the throttle plate at a 90° angle to the direction of airflow, and so that the nozzle tip is flush with the inside of the intake tube or protruding slightly to ensure an uninterrupted spray pattern.

- Install the nozzle assembly into the threaded intake tube.
- Using a 5/16" open end wrench, tighten the nozzle assembly 1/2 turn past finger tight so that the nozzle head is flush with the inside of the intake tube.
- Re-install the vehicle's intake tube into its proper mounting location.

### Graph Color

- Setting screen 5 (see right) is used to select what Graph color will be displayed on screen. Using the red buttons below the up and down arrows adjust the color to the desired setting (Red, Blue, Green, Yellow, Orange, Purple, White) available. Press the red button underneath the arrow pointing right to move to setting screen 6.

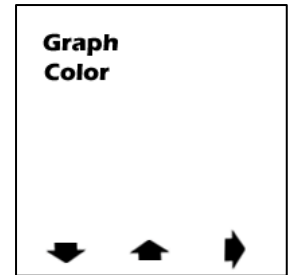

### Injection On/Off

- Setting screen 6 (see right) is used to toggle between on/off mode. In on mode injection will take place based off the boost settings in the unit. In off mode no injection will take place and the "off" icon will be shown on the main screen. In this mode the controller will only function as a boost gauge.

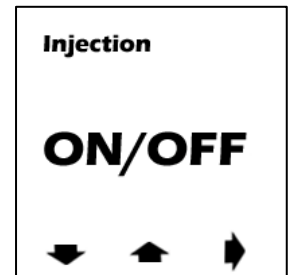

### Controller Operation Example

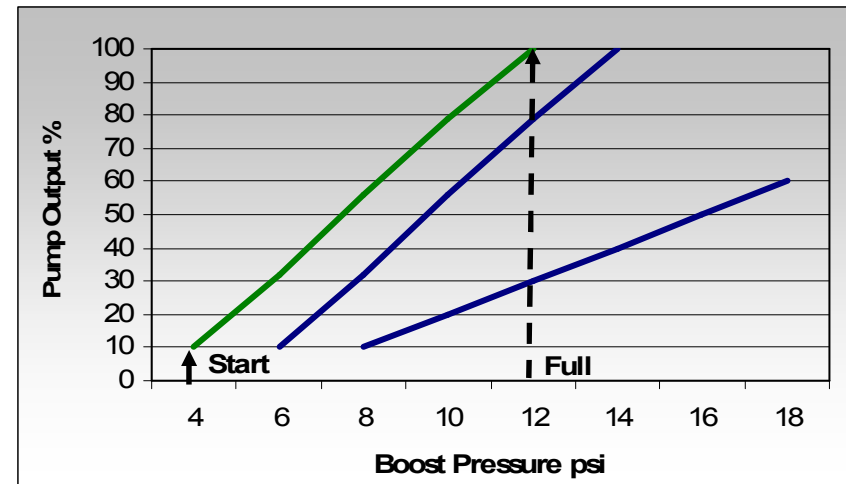

For the middle line, the chart shows the Start dial at 6 psi and the Full dial at 13 psi. At 6 psig of boost pressure the pump will operate at 10%. At 13 psig of boost pressure, the pump will deliver 100% of injection pressure. For boost pressure readings between the Start and Full settings, the controller will linearly adjust the pump pressure as shown on the graph.



### Injection Start

- Setting screen 1 (see right) is used to select what boost pressure will start injection. This should be set to  $1/3^{\text{rd}}$  to  $1/2$  the engines max boost output using the red buttons below the up and down arrows to adjust the PSI to desired setting. Press the red button underneath the arrow pointing right to move to setting screen 2.

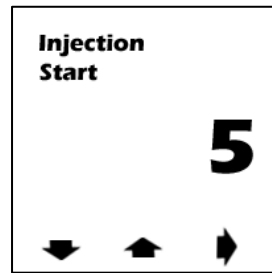

### Max Injection

- Setting screen 2 (see right) is used to select what boost pressure will correlate to max injection. This should be set to the vehicles maximum boost level using the red buttons below the up and down arrows to adjust the psi to desired setting. Press the red button underneath the arrow pointing right to move to setting screen 3.

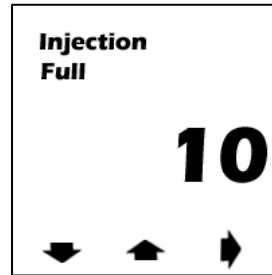

### Power Nozzle

- Setting screen 3 (see right) is used to select what boost pressure a second stage of injection will be triggered. This should be set to the vehicles maximum boost level using the red buttons below the up and down arrows to adjust. **If a dual stage system is not being used this must be set above 50 psi to the "off" setting to avoid fault code.** Press the red button underneath the arrow pointing right to move to setting screen 4.

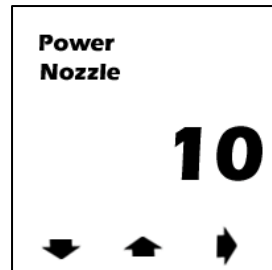

### Text Color

- Setting screen 4 (see right) is used to select what text color will be displayed on screen. Using the red buttons below the up and down arrows adjust the color to the desired setting (Red, Blue, Green, Yellow, Orange, Purple, White) available. Press the red button underneath the arrow pointing right to move to setting screen 5.

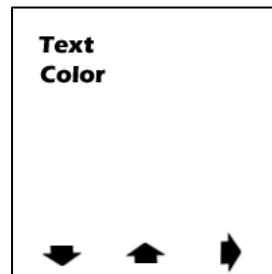

### \*\*\*Caution\*\*\*

Mounting the nozzle after the throttle body will cause siphoning due to engine vacuum. To prevent siphoning, a solenoid (Part #40060) must be installed.

## Installation- Mechanical (cont'd)

### Step 6 Nozzle Connection

- Fit the high pressure tubing between the pump outlet and the nozzle assembly, ensuring there are no kinks in the line and there is no stress on the push-lock fittings.
- Cut tubing straight and remove burrs so that the fluid line properly seals against the internal o-rings.
- Insert tubing into the push-locks until fully seated, and pull lightly against push-locks to ensure proper installation.

**\*\*Tubing should connect to push-lock fittings at shallow angles. Having an immediate sharp bend may unseat the tubing from the internal o-ring and create a leak\*\***

- Use tie wraps to help route tubing and to ensure it doesn't contact moving or hot parts in the engine compartment.

**\*\*Continual insertion and removal from push-lock fittings will mar the end of the tubing. Over time the internal gripping teeth may lose their hold of the tubing which may create a leak. If this occurs simply remove the tubing and make a fresh, square cut\*\***

# Installation- Electrical

## Step 1 Variable Controller Installation

- Mount controller in desired location using gauge pod assembly and o-ring or other 2 1/16 gauge pod.
- Connect vacuum/boost hose (black silicon hose) from controller to accurate boost source using included “T” fitting and supplied 1/8” boost line. Secure connections with supplied tie wraps.

**⚠ CAUTION: Disconnect the negative battery terminal while connecting wires to prevent electrical fire or damage to controller.**

- Using Supplied Large Eyehook connect BLACK wire to good ground location.
- Using Supplied Blue Butt connect GREEN wire to Pump RED power wire.
- Using Supplied Blue Butt connect PURPLE wire to one level switch black wire. Using Supplied Large Eyehook connect other level switch black wire to good ground location. These wires are interchangeable and either one can connect to controller/ground.
- Using Supplied wire splice connect RED wire to 12Volt key on source.
- YELLOW wire is only used to control a second stage of water/methanol. If solenoid and dual nozzle upgrade is not being used YELLOW wire can be tied out of the way. If solenoid/dual nozzle upgrade is being used follow wiring diagram on the right to properly insert dual nozzle upgrade and solenoid. The wires on the solenoid are interchangeable and either one can connect to ground or the yellow wire from the controller.

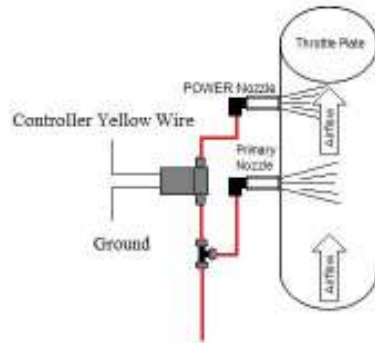

## \*\*\*Caution\*\*\*

Do not route wires near hot or moving parts. Use corrugated wire loom and tie wraps to protect and route wires.



**Always have a good electrical ground connection. Poor ground will result in erratic operation of controller.**

## Variable Controller Settings/Screens/Functions

### Main Screen

- Main Screen (see right) is used to monitor boost pressure, injection, low level, second stage activation, and to prime the system.
  - To prime the system press the red button underneath “P”. This will command 100% injection briefly to fully prime the system. **ONLY ENGAGE PRIME WHEN ENGINE IS RUNNING!**
  - Boost pressure is displayed in PSI on the upper left of the screen
  - Percentage of Injection is displayed using the graph in the middle of the screen. When injection is turned “Off” the graph will display the text “Off”.
  - When a low level situation occurs the outside of the screen will blink yellow alerting the user to fill the water-methanol reservoir.
  - (Dual Stage Systems Only) When a second stage of water-methanol is activated a asterisk will appear where “PSI” is located alerting the user or both stages injecting.
  - To enter the setting screens press the red button directly under the arrow on the bottom right.

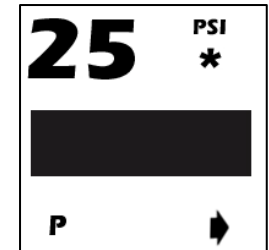

**⚠ CAUTION: Do not operate the prime button when the engine is not running. Only engage priming of the system when the engine is on.**