



RHINO-RACK®

Chevrolet Tahoe, Chevrolet Suburban, GMC Yukon/ Yukon XL RCP43-BK

Important:

1. Check the Rhino-Rack website to ensure you have the latest issue of these instructions.
2. Please refer to your fitting instruction to ensure that the roof racks are installed in the correct locations.
3. Check the contents of kit before commencing fitment and report any discrepancies.
4. Place these instructions in the vehicle's glove box after installation is complete.
5. These instructions must be followed for warranty to be upheld.

Fit Time: 15 min

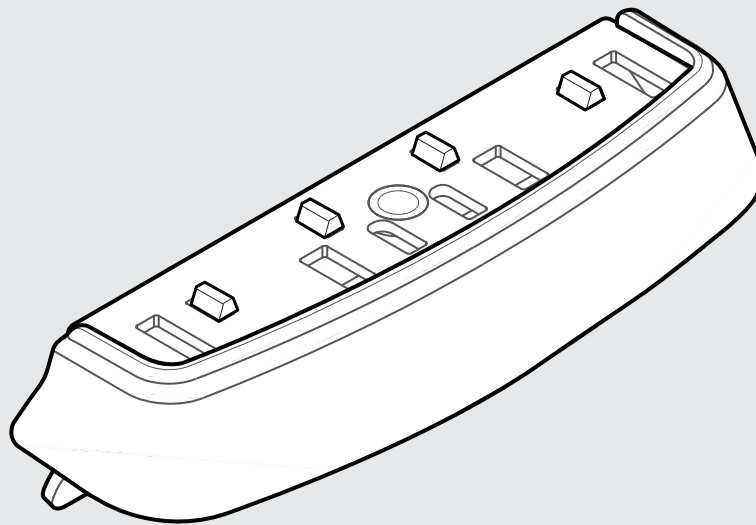

RCP43-BK Instructions

Carrying Capacity





Check your vehicle owners hand book for vehicle maximum carrying capacity. Please ensure you use the vehicle manufacturer's maximum roof allowance if it is lower than the figure listed in this instruction.

Load must be evenly distributed over the system.

VISIT THE ONLINE
LOAD LIMIT
CALCULATOR FOR
CURRENT LOAD DATA



DYNAMIC LOAD LIMIT :
***USE THE VEHICLE MANUFACTURER'S MAXIMUM ROOF ALLOWANCE IF IT IS LOWER THAN THE FIGURE LISTED**

 CARGO	 SYSTEM WEIGHT	 LOAD LIMIT		 Max kg
UP TO 75 KG 165 lbs	+ 5 KG 11 lbs	=		UP TO 80 KG 176 lbs
				*VEHICLE MANUFACTURER'S ROOF LOAD LIMIT

 **STATIC LOAD LIMIT: UP TO 200KG / 440LBS***



Cargo Load Limit

Total permissible weight allowed on top, and attached to roof racks whilst the vehicle is in motion.



System Weight

Total weight of the roof rack system. (Crossbars, Backbone, Platform)



Max System Load Capacity

Please ensure you use the vehicle manufacturer's maximum roof allowance if it is lower than the figure listed in the fitting chart.



Vehicle Manufacturer's Load Limit

Total permissible weight attached to the roof of the car. This is inclusive of the weight of the roof rack system.

Warning

- Check part number or kit is correct for use with your vehicle.
- Do not attempt to fit the rack system to your vehicle unless you fully understand these fitting instructions. Please direct any questions regarding fitting to the dealer from where the roof racks were purchased.
- Off-road conditions can be much more rigorous. Extreme care must be taken on any driven path that does not contain a surface protection layer (tar/bitumen).
- Roof racks must be removed when vehicle is put through an automatic car wash.
- With utility vehicles, the cabin and the canopy move independently. Roof racks and vehicle can be damaged if the item transported is rigidly fixed at points on both the cabin and canopy. Instead, rigidly fix to either the cabin roof racks or the canopy roof racks.
- Always ensure you fasten your load securely.
- Use only non-stretch fastening ropes or straps to attach cargo to your load.

In service maintenance checks

- All bolt connections should be checked after driving a short distance when you first install your roof racks.
- All bolted connections should be checked again at regular intervals (weekly is recommended, depending on road conditions, usage, loads and distances travelled).
- All bolted connections should be checked each time they are re-fitted.
- Off-road conditions are more rigorous. Check all bolted connections and your load more regularly.
- Ensure that your vehicle manufacturer's GVM, and gross axle weights are not exceeded (refer to vehicle owner's manual).

Torque Settings

Unless stated otherwise in these instructions, all fasteners should be set to the following torque settings:

- M6: 4-5Nm (3-4lbs/ft),
- M8: 8-10Nm (6-7.5lbs/ft)
- M10: 16-18Nm (12-13lbs/ft).





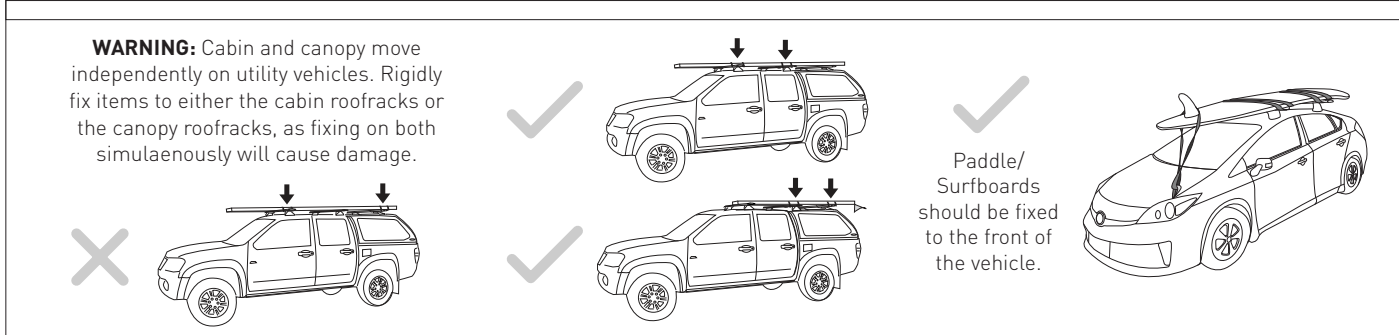
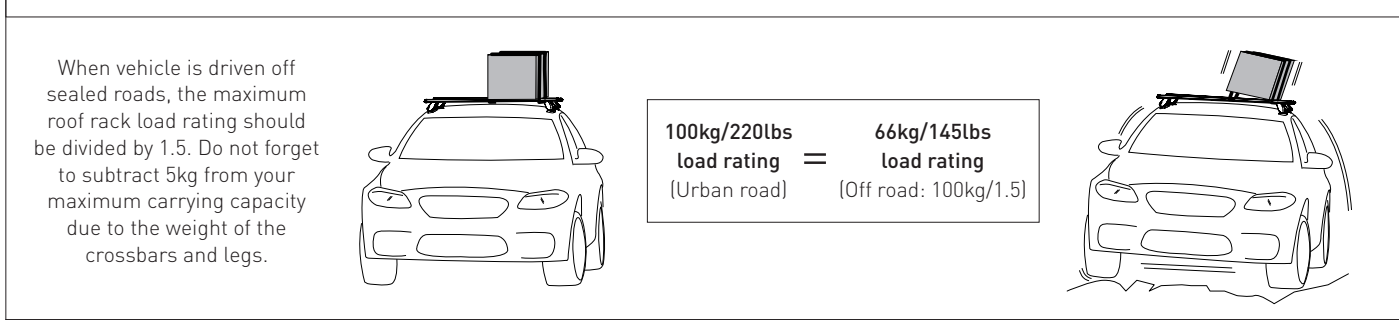
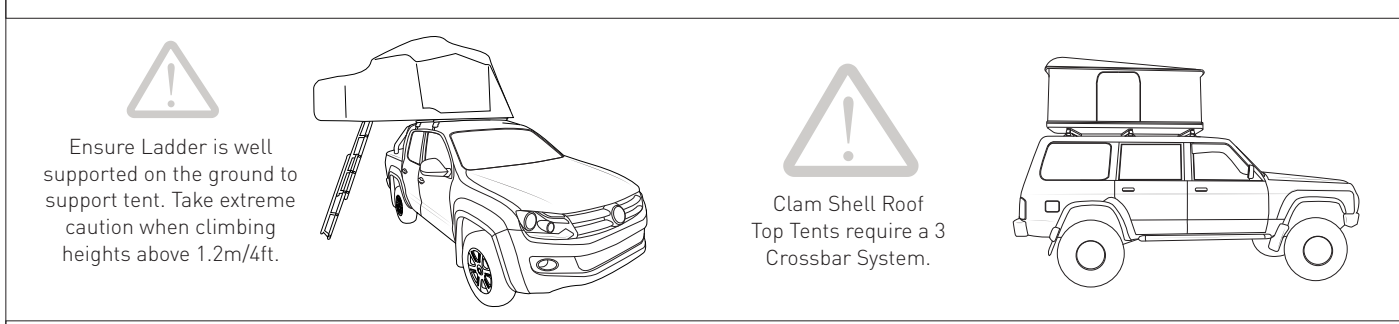
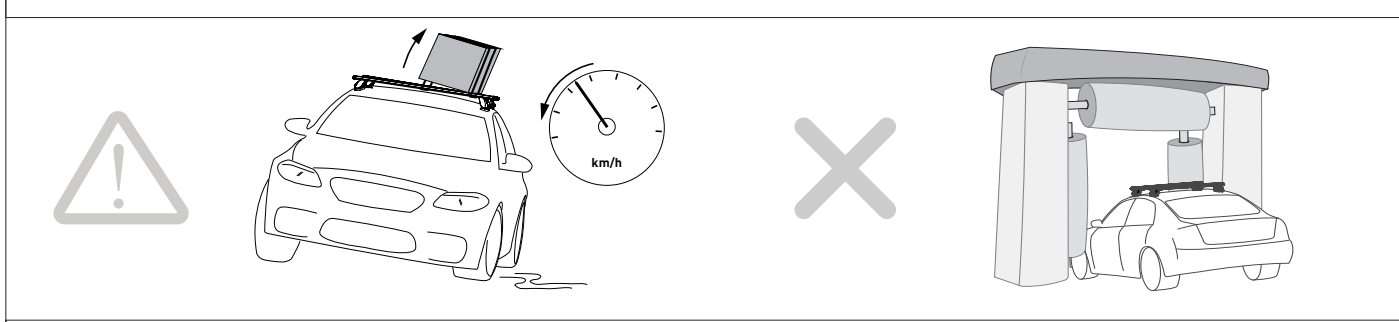
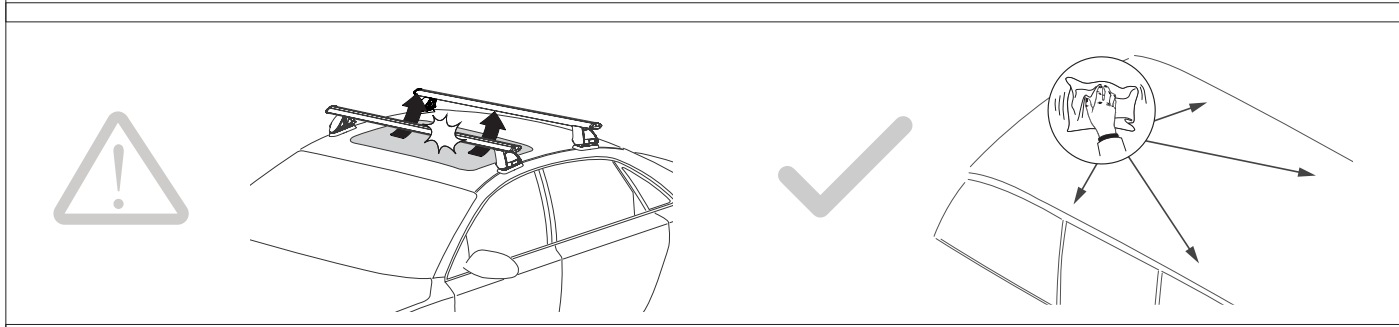
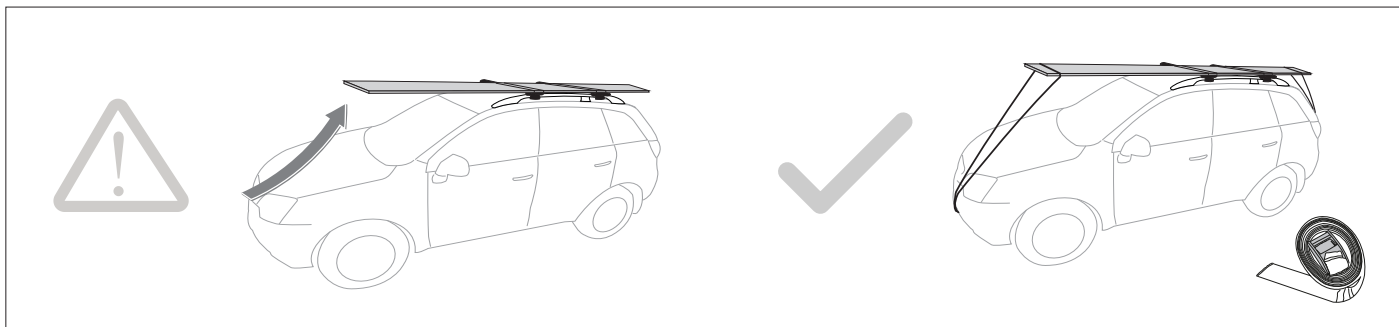

Note for Dealers and Fitters

It is your responsibility to ensure these fitting instructions are given to the end user or client. These instructions remain the property of Rhino-Rack Australia Pty. Ltd. and may not be used or changed for any other purpose than intended.

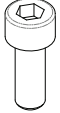
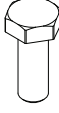
RCP43-BK Instructions

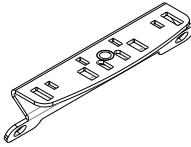
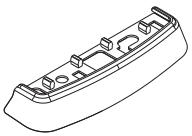
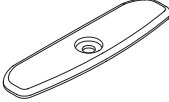
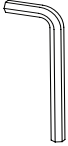

Parts List

<p>M6 x 16mm Socket Head Cap Screw</p>  <p>A x8</p>	<p>M6 x 16mm Hex Set screw</p>  <p>B x4</p>	<p>M6 Spring washer</p>  <p>C x12</p>	<p>M6 x 12.5mm Flat Washer</p>  <p>D x8</p>
<p>M6 x 16mm Flat Washer</p>  <p>E x4</p>	<p>M6 Washer (used on cover plate)</p>  <p>F x4</p>	<p>RLCP Bracket</p>  <p>G x4</p>	<p>Rubber Skirt</p>  <p>H x4</p>
<p>Cover Plate</p>  <p>I x4</p>	<p>Allen Key</p>  <p>J x1</p>	<p>Instruction</p>  <p>K x1</p>	

FOR SINGLE BAR KIT:

Item	Component	Qty
A	M6 x 16 Cap Head Screw	4
B	M6 x 16mm Hex Setscrew	2
C	M6 Spring Washer	6
D	M6 x 12.5mm Flat Washer	4
E	M6 x 16mm Flat Washer	2
F	M6 Washer (used on cover plate)	2
G	RLCP Bracket	2
H	Rubber Skirt	2
I	Cover Plate	2
J	Allen Key	1
K	Instructions	1

Tools required:
 T1 - Flathead Screwdriver
 T2 - 10mm Socket Wrench/ Spanner
 T3 - Torx Key

- 1** Select fixed mounting points for your vehicle.
ROOF RAIL SIDE VIEW:

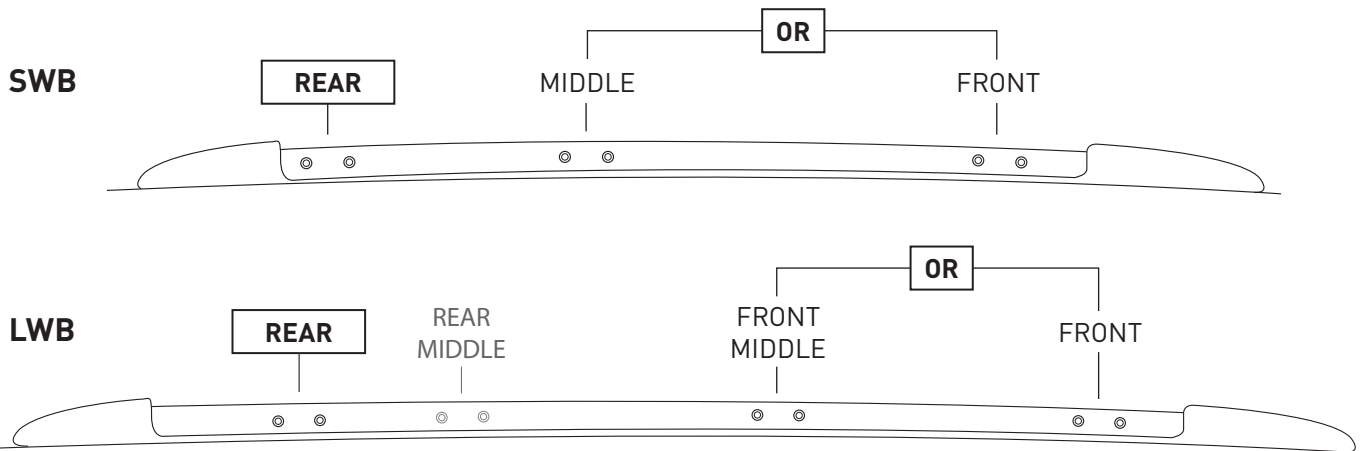

- 2**

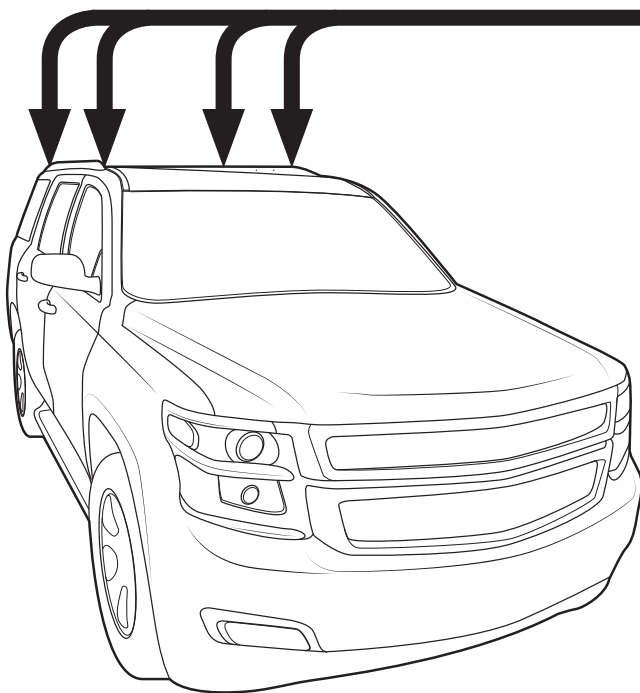

Remove thread protection clips selected in Step 1.

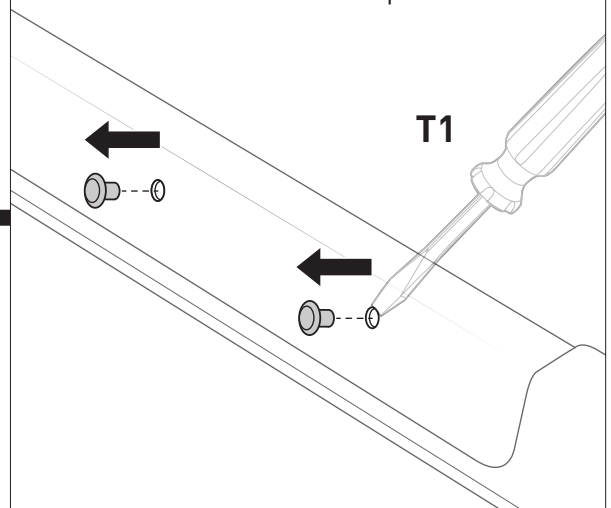

Remove factory rails if installed.

