



NOS LS1 Plate Kit

Kit Number 05168NOS



OWNER'S MANUAL

P/N 199R10361

CONGRATULATIONS on purchasing your NOS Nitrous Oxide Injection System! Your system is composed of the highest quality components available. It should provide many miles of trouble-free performance when used correctly. If you have any questions regarding the performance of your system, **call NOS Technical Service at 1-866-GOHOLLEY, fax to 1-270-781-9772, or for online help, refer to the Tech Service section of our website: www.holley.com.**

NOTICE: The installation of Nitrous Oxide Systems, Inc. products signifies that you have read this document and have agreed to the terms stated within.

It is the purchaser's responsibility to follow all installation instruction guidelines and safety procedures supplied with the product as it is received by the purchaser to determine the compatibility of the product with the vehicle or the device the purchaser intends to install the product on.

Nitrous Oxide Systems Inc. assumes no responsibility for damages occurring from accident, misuse, abuse, improper installation, improper operation, lack of reasonable care, or all previously stated reasons resulting from incompatibility with other manufacturers' products.

Nitrous Oxide Systems Inc. assumes no responsibility or liability for damages incurred by the use of products manufactured or sold by Nitrous Oxide Systems Inc. on vehicles used for competition or racing.

Nitrous Oxide Systems Inc. neither recommends nor condones the use of products manufactured or sold by Nitrous Oxide Systems Inc. on vehicles, which may be driven on public roads or highways, and assumes no responsibility for damages incurred by such use.

NOS nitrous oxide is legal for use in most states when used in accordance with state and local traffic laws. NOS does not recommend or condone the use of its products in illegal racing activities.

NOS has not pursued California Air Research Board (CARB) exemptions for its kits, hence, they are not legal for use on pollution-controlled vehicles in California. A correctly installed NOS nitrous system should not alter the emission control performance of your vehicle under standard EPA test cycle conditions.

HAZARDS DEFINED

This manual presents step-by-step instructions that describe the process of installing your NOS Nitrous Oxide Injection System. These procedures provide a framework for the installation and operation of this kit. Parts are referenced by name and number to avoid confusion. Within the instructions, you are advised of potential hazards, pitfalls, and problems to avoid. The following examples explain the various hazard levels:

WARNING! Failure to comply with instructions may result in injury or death.

CAUTION! Failure to comply with instructions may result in damage to equipment.

NOTE: This information is important, needs to be emphasized, and is set apart from the rest of the text.

HINT: These special instructions provide a handy work tip.

NITROUS OXIDE INJECTION SYSTEM SAFETY TIPS

WARNINGS

IT IS NOT LEGAL TO ENGAGE NITROUS OXIDE INJECTION SYSTEMS ON PUBLIC ROADS OR HIGHWAYS. NITROUS OXIDE INJECTION SYSTEMS ARE ONLY TO BE ENGAGED DURING SANCTIONED COMPETITION OR RACING EVENTS.

Do not attempt to start the engine if the nitrous has been injected while the engine was not running. Disable the ignition system (consult owner's manual) and turn the engine over with the throttle wide open for several revolutions before attempting to start. Failure to do so can result in extreme engine damage.

Never permit oil, grease, or any other readily combustible substances to come in contact with cylinders, valves, solenoids, hoses, and fittings. Oil and certain gases (such as oxygen and nitrous oxide) may combine to produce a highly flammable condition.

Never interchange nitrous and fuel solenoids. Failure to follow these simple instructions can result in extreme engine damage and/or personal injury.

Never drop or violently strike the bottle. Doing so may result in an explosive bottle failure.

Never change pressure settings of safety relief valve on the nitrous bottle valve. Increasing the safety relief valve pressure settings may create an explosive bottle hazard.

Please note that the NOS bottle label has changed to a two-part assembly. The first label is already located on the bottle. Upon filling your bottle with nitrous oxide, apply the (second) material information label in the area indicated in the picture to the right.

NOTE: The material information decal is located in the same plastic bag as the bottle.

WARNING! Once the nitrous bottle has been filled, it must be shipped according to the applicable transportation and shipping regulations!

Do not deface or remove any markings, which are used for content identification.

Nitrous bottle valves should always be closed when the system is not being used.

Notify the supplier of any condition that may have permitted any foreign matter to enter the valve or bottle.

Keep the valves closed on all empty bottles to prevent accidental contamination.

After storage, open the nitrous bottle valve for an instant to clear the opening of any possible dust or dirt.

It is important that all threads on the valves and solenoids are properly mated. Never force connections that do not fit properly.

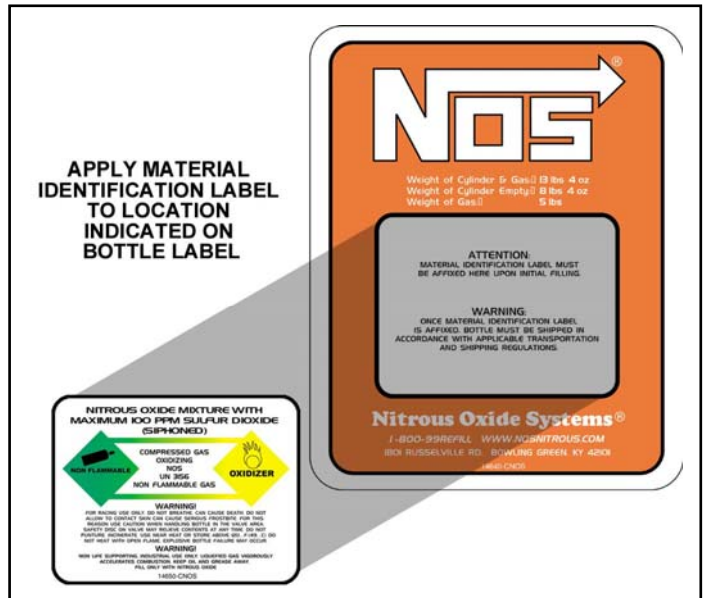

TABLE OF CONTENTS

WHAT IS NITROUS OXIDE?	5
DO'S AND DON'TS OF NITROUS OXIDE	5
Chapter 1 Introduction to Your NOS Nitrous Oxide Kit	5
1.1 General Information.....	5
1.2 System Requirements	6
1.3 Kit Components	6
Chapter 2 Kit Installation.....	8
2.1 Bottle Mounting Instructions	8
2.2 Bottle Orientation.....	8
2.3 Bottle Installation	8
2.4 05168NOS Kit Plate Installation	9
2.4.1 Corvette Plate Installation	9
2.4.2 Camaro Plate Installation	10
2.5 05168NOS Solenoid Mounting.....	10
2.5.1 Corvette Solenoid Mounting.....	10
2.5.2 Camaro Solenoid Mounting.....	12
2.6 Electrical System	12
2.8 Testing for Proper Operation <u>without</u> Nitrous Bottle Hook Up.....	14
2.9 Preparing for Operation	14
Chapter 3 Tuning	14
Chapter 4 Determining Optimum System Performance	15
Chapter 5 Alternate Sensor, Actuator, and Switch Components	16
Chapter 6 Routine Maintenance	16
6.1 Nitrous Solenoid Filter	16
6.2 Nitrous Solenoid Plunger.....	17
6.2.1 General Information.....	17
6.2.2 Nitrous Solenoid Plunger Disassembly and Inspection	17
Appendix A Troubleshooting Guide	18
Nitrous Oxide Accessories	19

WHAT IS NITROUS OXIDE?

NITROUS OXIDE...

...Is a cryogenic gas composed of nitrogen and oxygen molecules

...Is 36% oxygen by weight

...Is non-flammable by itself

...Is stored as a compressed liquid

...Exists in two grades—U.S.P. and Nitrous Plus:

- ❑ U.S.P. is medical grade nitrous oxide; its common use is dental and veterinary anesthesia. It is also commonly used as a propellant in canned whipped cream. U.S.P. is not available to the public.
- ❑ Nitrous Plus differs from U.S.P. in that it contains trace amounts of sulphur dioxide added to prevent substance abuse. Nitrous Plus is intended for automotive applications and is available for sale to the public.

In automotive applications, Nitrous Plus and fuel are injected into the engine's intake manifold, which produces the following results:

- ❑ Lowers engine intake air temperature, producing a dense inlet charge.
- ❑ Increases the oxygen content of the inlet charge (air is only 22 percent oxygen by weight).
- ❑ Increases the rate at which combustion occurs in the engine's cylinders.

DO'S AND DON'TS OF NITROUS OXIDE

Do's

- ❑ Read all instructions before attempting to install your NOS nitrous system.
- ❑ Make sure your fuel delivery system is adequate for the nitrous jetting you have chosen. Inadequate fuel pressure or flow will result in engine damage.
- ❑ Use 14 gauge (minimum) wire when installing electrical system components.
- ❑ Use high-quality connections at all electrical joints.
- ❑ Use Teflon-based paste on pipe-style fittings.
- ❑ Make sure your engine and related components (ignition, carburetor, and driveline) are in proper working condition.
- ❑ **If nitrous is accidentally injected into the engine when it is not running, remove the engine ignition wires, open the throttle, and crank the engine 10 to 15 seconds before starting. Failure to do so can result in an explosive engine failure.**
- ❑ **Use your NOS nitrous system only at wide-open throttle and at engine speeds above 3000 RPM.**
- ❑ **Install a proper engine to chassis ground. Failure to do so may result in an explosive failure of the main nitrous supply line.**
- ❑ Use a high-quality fuel, as suggested in Chapter 3, Baseline Tuning Suggestions.

Don'ts

- ❑ Engage your nitrous system with the engine off. Severe engine damage can occur.
- ❑ Modify NOS nitrous systems (if you need a non-stock item, call NOS Technical Service for assistance)
- ❑ Overtighten AN type fittings.
- ❑ Use Teflon Tape on any pipe threads. Pieces of Teflon tape can break loose and become lodged in the nitrous or fuel solenoids or solenoid filters. Debris lodged in a nitrous or fuel solenoid can cause catastrophic engine failure.



- ❑ Use sealant of any kind on AN type fittings.
- ❑ Allow nitrous pressure to exceed 1100 psi. Excessive pressure can cause swelling or in extreme cases failure of the nitrous solenoid plunger. Solenoid plungers are designed so that pressure-induced failures will prevent the valve from operating. No leakage should occur with this type of failure.
- ❑ **Inhale nitrous oxide. Death due to suffocation can occur.**
- ❑ **Allow nitrous oxide to come in contact with skin. Severe frostbite can occur.**
- ❑ **Use octane boosters that contain methanol. Fuel solenoid failure may occur, producing severe engine damage.**

Chapter 1 Introduction to Your NOS Nitrous Oxide Kit

1.1 General Information

Kit Number 05168NOS is intended for use on 1997-2004 GM LS1 engines. Power output is increased by 75-250HP over stock.

1.2 System Requirements

When used correctly, Kit Number 05168NOS is designed to work with stock LS1 internal engine and driveline components. The three jet combinations in this kit generate 100HP, 125HP, or 150HP gains. Colder plugs (non-platinum, gapped at .035) are recommended. Check **Table 2** in the back of the manual for recommended spark plug heat range selection. If the jetting is increased over 150 HP, it is advised to upgrade the fuel delivery system to ensure safe operation.

1.3 Kit Components

Before beginning the installation of your NOS kit, compare the components in your kit with those listed in Table 1. If any components are missing, please contact NOS Technical Support at 1-866-GOHOLLEY.

Table 1 Kit Number 05168NOS Parts List

Item	Description	Quantity	NOS P/N
(1)	Bottle Nut Adapter	1	16230NOS
(2)	Bottle Valve Washer	1	16210NOS
(3)	10 lb. Bottle w/ racer safety	1	14745-TPINOS
(4)	Blow Down Tube	1	16160NOS
(5)	Bottle Mounting Bracket, Short	1	14126-SNOS
(6)	Bottle Mounting Bracket, Long	1	14127-SNOS
(7)	N ₂ O Super Pro Shot Solenoid	1	16045NOS
(8)	Cheater Fuel Solenoid	1	16050NOS
(9)	Relay Wiring Harness	1	15604-SNOS
(10)	30 Amp Relay	1	15618NOS
(11)	Throttle Body / Plate Gasket	1	8R2254
(12)	6an – 1/4NPT Nitrous Filter	1	15564NOS
(13)	4AN – 1/8NPT 90° Fuel Filter (Red)	1	15573NOS
(14)	4AN – 1/8 NPT 90° Adapter (Red)	1	17661NOS
(15)	4AN – 1/8 NPT Adapter (Blue)	1	17960NOS
(16)	4AN – 1/8NPT Adapter (Red)	1	17961NOS
(17)	0.031" Flare Jet	1	13760-31NOS
(18)	0.035" Flare Jet	1	13760-35NOS
(19)	0.038" Flare Jet	1	13760-38NOS
(20)	0.051" Flare Jet	1	13760-51NOS
(21)	0.055" Flare Jet	1	13760-55NOS
(22)	0.063" Flare Jet	1	13760-63NOS
(23)	6AN 14 ft. Hose (Blue)	1	15475NOS
(24)	4AN 90° 1 ft. Hose (Red)	1	15215NOS
(25)	4AN to 3AN 18" Hose (Blue)	1	15345NOS
(26)	4AN to 3AN 18" Hose (Red)	1	15346NOS
(27)	LS1 Plate Assembly***	1	40R819A
(28)	Screws, Solenoid Mounting*	4	16501-SNOS
(29)	Brackets, Solenoid	2	16500-VSNOS
(30)	Bracket, LS1 Microswitch	1	49R2071
(31)	Bracket, Throttle Switch C5	1	49R2086
(32)	Bracket, Throttle Cable Extension	1	49R2095
(33)	Power Steering Pump Spacers	2	40R820
(34)	Power Steering Pump Bolts	2	5R2205
(35)	Throttle Cable Extension Screws	2	5R2197
(36)	Throttle Body Bolts M6 x 45mm	3	5R2201
(37)	14 Gauge Blue Wire 8 ft.	1	15751-VSNOS
(38)	14 Gauge Red Wire	1	15752-SNOS
(39)	6AN Black Cap Plug	1	A1002-SNOS
(40)	Basic Wire Pack*	1	15612-VSNOS
	Rocker Switch	1	15602NOS
	15 amp Fuse	1	208R2
	Microswitch	1	15640NOS
	4-40 x 1 SL PAN HD M Screw*	2	15647-SNOS
	4-40 Hex Nut*	2	15648-SNOS
	1/4" Ring Terminal	3	15882-SNOS
	Blue Female Spade Terminal .25	7	15885B-SNOS
	Blue Male Spade Terminal .25	1	15886B-SNOS
	Scotchlock	1	15891-SNOS

Figure 1 Kit Number 05168NOS Component Identification

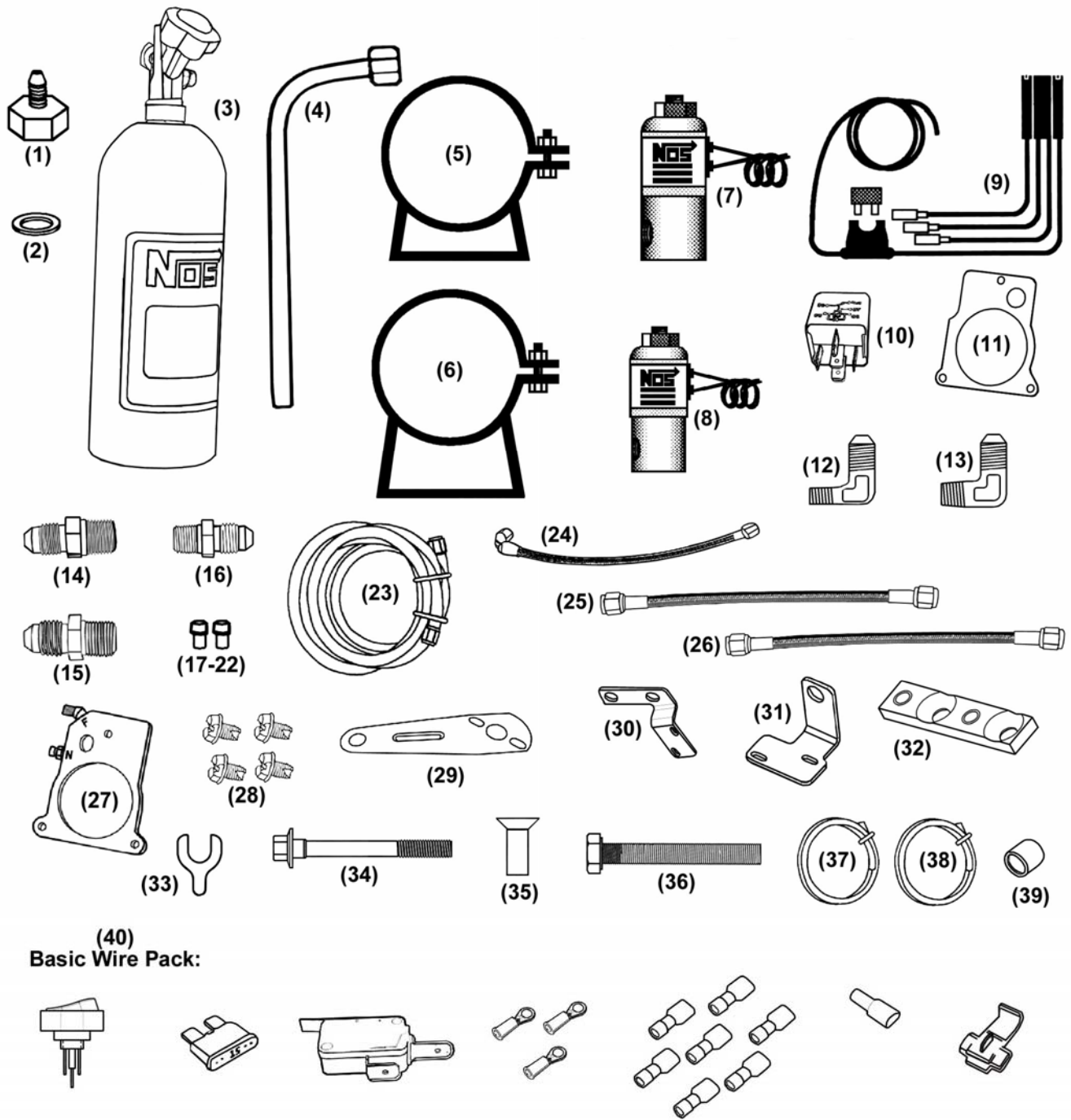

-Parts Shown are not to scale-

Chapter 2 Kit Installation

2.1 Bottle Mounting Instructions

Accurate calibration of your NOS nitrous system depends on the bottle remaining at a stable temperature. Mount the bottle away from heat sources, such as the engine compartment or exhaust system, and away from windows, where the bottle is exposed to direct sunlight.

2.2 Bottle Orientation

Bottle placement is critical to the performance of your NOS nitrous system. It is important to understand how the bottle valve and siphon tube are assembled to properly orient the bottle in your vehicle and ensure that it picks up liquid nitrous while undergoing acceleration. All nitrous bottles are assembled so that the bottom of the siphon tube is at the bottom of the bottle and opposite the bottle label (Figure 2).

Whenever the bottle is mounted in a lay-down position, the valve handle must be towards the front of the vehicle with the label facing up (Figure 3A).

If the bottle is mounted vertically, the valve handle and label must face toward the front of the vehicle (Figure 3B). This orientation will position the siphon tube at the back of the bottle where the liquid N₂O will be during acceleration.

WARNING! DO NOT attempt to remove the siphon tube without completely emptying the bottle of all N₂O and pressure.

A bottle mounted upside-down must have the siphon tube removed before use (Figure 3C). Non-siphon bottles can be specially ordered from NOS.

If the bottle must be mounted parallel to the axles of the vehicle (sideways), the valve handle and label must be angled at approximately 45° toward the front of the vehicle (Figure 3D). This orientation will position the siphon tube toward the rear of the bottle.

NOTE: When using a bottle with a siphon tube, the tall bracket should be at the valve end of the bottle and the short bracket at the bottom (Figure 3E).

The most efficient mounting is the lay-down position (Figure 3A) with the valve handle toward the front of the vehicle. This position allows the greatest amount of liquid to be used before the siphon tube begins to pick up gaseous nitrous oxide.

Find a position in the rear of your vehicle that meets your personal preference. Make sure that it meets the guidelines show in Figure 3.

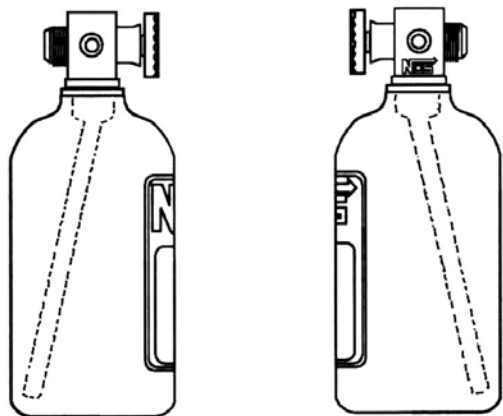

Figure 2 Nitrous Bottle Siphon Tube Orientation

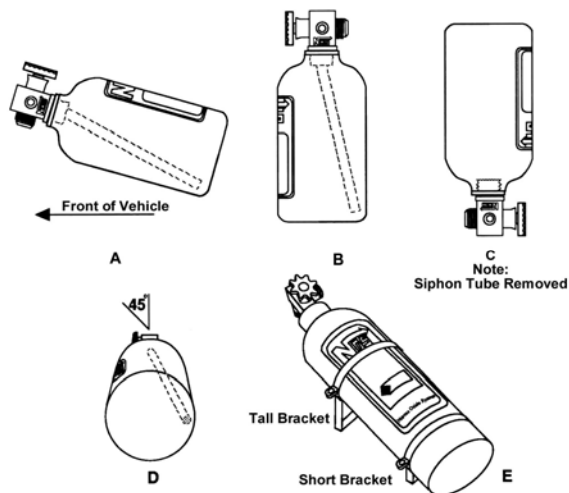

Figure 3 Nitrous Bottle Mounting Orientations

2.3 Bottle Installation

Before mounting a nitrous bottle in a racing vehicle intended for use in sanctioned events, check with the sanctioning association for any rules regarding this subject. Most associations require the bottle to be mounted within the confines of the safety roll cage with the safety pressure relief cap vented away from the driver's compartment. This feature is included in the 05168NOS kit.

NOTE: Numbers in parentheses () refer to the parts list (Table 1).

1. Install the bottle nut adapter (1) and washer (2) on the nitrous bottle (3), and tighten securely.
2. Slip the bottle mounting brackets (4 & 5) onto the nitrous bottle, as shown in Figure 3E.
3. Locate the bottle assembly in the desired mounting location, ensuring that the location will provide easy access to the bottle valve, hose connection, bracket clamp bolts to facilitate bottle changing and through hole of the blow-down tube.
4. Use the assembled bottle/bracket unit as a pattern to mark for hole drilling. Drill four 11/32" holes in the mounting surface for the bottle bracket bolts. **Make sure the holes are in a position that does not damage other components.**

CAUTION! When drilling or punching holes for these fasteners, be aware what components, wires, hoses or fluid reservoirs are located or routed behind the general area to avoid vehicle or equipment malfunction.

5. Mount the brackets securely to the surface (recommended minimum of 5/16" bolts or No. 12 sheet metal screws).
6. Secure the nitrous bottle in the mounting brackets and tighten the bracket clamps.
7. Route the blow-down tube through the hole in the trunk, install and fasten to the fitting on the bottle valve.

2.4 05168NOS Kit Plate Installation

WARNING! Do not smoke, carry lighted tobacco, or allow an open flame of any type when working on or near any fuel-related components. Highly flammable mixtures are always present and may be ignited. Failure to follow these instructions may result in personal injury.

2.4.1 Corvette Plate Installation

1. Disconnect negative battery cable.
2. Unhook the inlet air temp (IAT) sensor in the air tube, TPS connector, and DBW connector on the throttle body (Figure 4).
3. Using an 8mm nut driver, loosen the air inlet flex tube on both ends (Figure 4). Remove the flex tube.

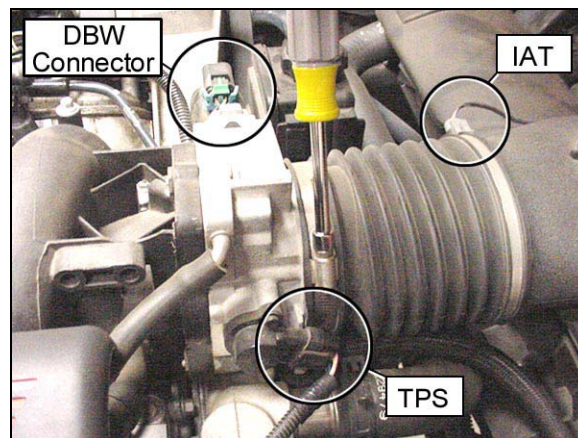

Figure 4

4. Use a 15 mm wrench to remove the power steering reservoir bracket bolts and replace with the supplied M10 x 90mm bolts. Insert the supplied spacers (Figures 5 & 6). Apply a small amount of anti-seize to the threads and tighten to 33 ft./lbs.

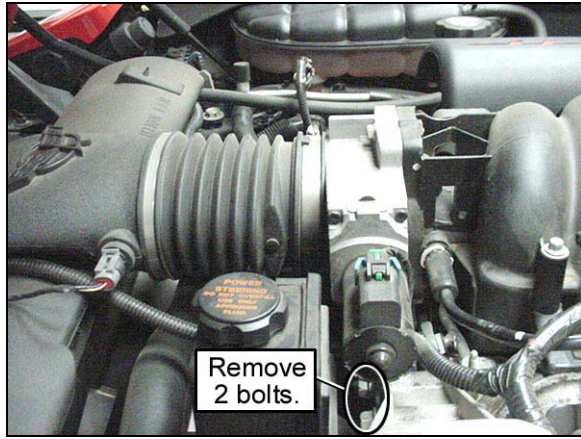

Figure 5

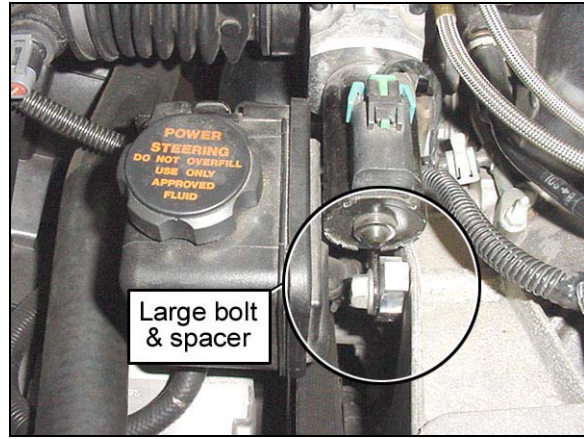

Figure 6

5. Using a 10mm socket, remove the throttle body bolts.
6. Assemble the nitrous plate, with the side labeled "INTAKE SIDE" toward the intake, gasket, and throttle body to the intake using the supplied M6 x 45mm bolts. Torque to 106 in./lbs. (~8.8 ft./lbs.).
7. Reconnect the air temperature sensor plug, TPS connector, and DBW connectors.

2.4.2 Camaro Plate Installation

1. Disconnect the negative battery cable.
2. Unhook TPS and inlet air temperature (IAT) sensors.
3. Use an 8mm nut driver and remove air inlet tube.
4. Unhook the throttle and cruise control cables.
5. Use a 10mm nut driver to remove throttle body.
6. Insert the plate and gasket. Reinstall the throttle body and torque the bolts to 106 in./lbs.
7. Remove the throttle cable bracket bolts.
8. Install the extension plate using the provided flat head cap screws.
9. Reinstall the stock throttle extension onto the extension using the stock bolts.
10. Reconnect the throttle and cruise control cables.
11. Reinstall the air inlet tube and reconnect the sensor plugs.

2.5 05168NOS Solenoid Mounting

2.5.1 Corvette Solenoid Mounting

NOTE: It is possible to mount the solenoids discretely under the fuel rail cover by following the below instructions.

1. Apply a small amount of Teflon thread sealant to the NPT threads of the **nitrous filter** (blue with screen) and insert into the **IN** side of the nitrous solenoid. In a bench vise, tighten at least 1-1/2 turns after finger tight. **(Figure 7)**
2. Apply a small amount of Teflon thread sealant to the NPT threads of the **nitrous outlet fitting** and insert into the **OUT** side of the nitrous solenoid. In a vice, tighten at least 1-1/2 turns after finger tight. **(Figure 8)**



Figure 7

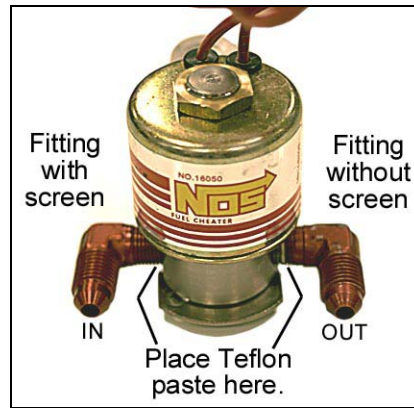

Figure 8

3. Apply a small amount of Teflon thread sealant to the NPT threads of the **90° fuel filter** (red with screen) and insert into the **IN** side of the fuel solenoid. Tighten at least 1-1/2 turns after finger tight, and then continue tightening until in place, as shown.
4. Apply a small amount of Teflon thread sealant to the NPT threads of the **90° fuel fitting** and insert into the **OUT** side of the fuel solenoid. Tighten at least 1-1/2 turns after finger tight, and then continue turning until in place, as shown.
5. Mark and bend the solenoid mounting brackets at 1.5" & 2.5". (**Figures 9, 10, & 11**)

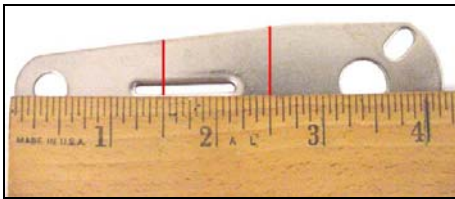

Figure 9



Figure 10



Figure 11

6. Attach the brackets to the solenoids.
7. Remove the fuel rail cover on the driver's side by gently pulling up to release the clips from the fuel rail and maneuver away from the fuel supply line.
8. The nitrous solenoid can mount to the 4th intake bolt back (2nd from rear) as shown and the fuel solenoid can mount to the third (center) intake bolt near the regulator. The nitrous solenoid should have the **IN** sides to the rear and the fuel solenoid should have the **OUT** side to the rear (Figure 12).
9. Plumb your nitrous supply line to the rear of the nitrous solenoid (Figure 13).

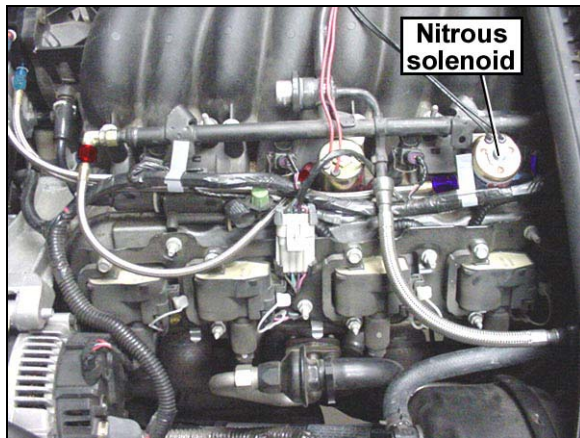

Figure 12

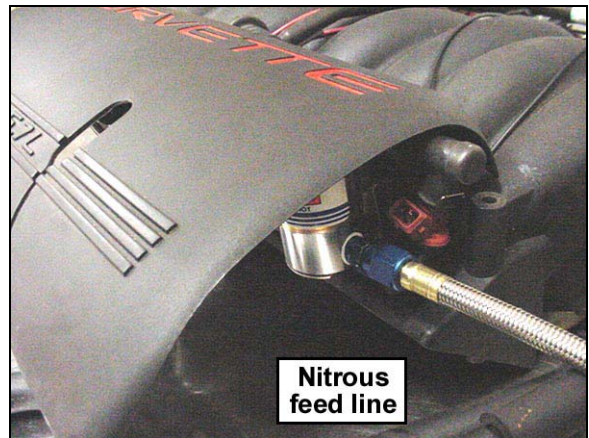

Figure 13

WARNING! Fuel in the fuel system remains under high pressure even after the engine is shut off. Before working on or disconnecting any of the fuel lines or fuel system components, the fuel pressure must be relieved. Failure to follow these instructions may result in personal injury.

10. Remove the stem from the Schrader type fitting in your fuel rail and plumb the fuel supply line to the **IN** side of your fuel solenoid.
11. Run your lines from the solenoids to the plate (Figure 15).

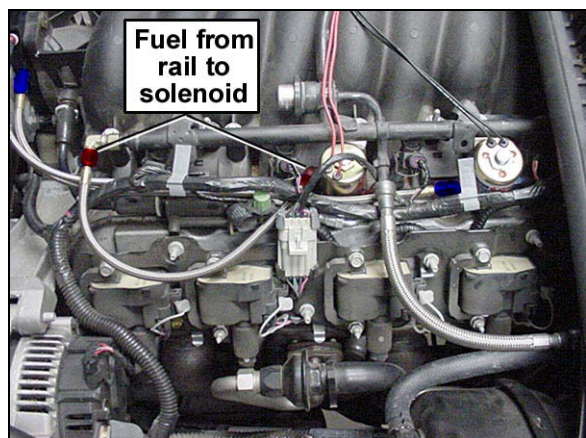

Figure 14

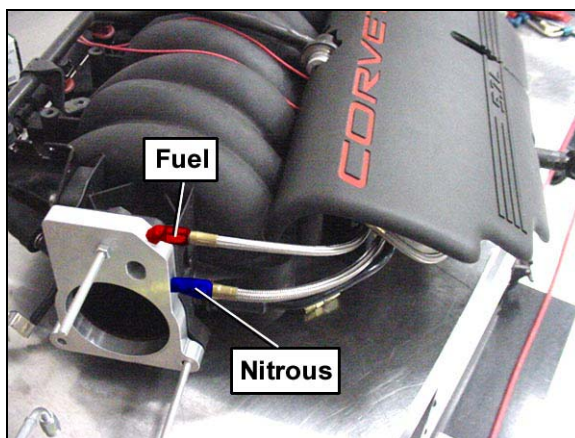

Figure 15

12. Proceed to the electrical system section.

2.5.2 Camaro Solenoid Mounting

1. Mount the solenoids using the supplied brackets in a suitable location, so the provided plumbing will attach to its intended destinations.
2. Apply a small amount of Teflon thread sealant to the NPT threads on the **nitrous filter** and **fuel filter fittings** (with screens) and install in the **IN** side of each solenoid. Tighten at least 1-1/2 turns after finger tight
3. Apply a small amount of Teflon thread sealant to the NPT threads on the **nitrous** and **fuel outlet fittings** and install in the **OUT** side of the solenoids. Tighten at least 1-1/2 turns after finger tight.

WARNING! Fuel in the fuel system remains under high pressure even after the engine is shut off. Before working on or disconnecting any of the fuel lines or fuel system components, the fuel pressure must be relieved. Failure to follow these instructions may result in personal injury.

4. Remove the Schrader stem fitting from the fuel test port and plumb the Red 12" 90° hose to the **IN** side of you fuel solenoid.
5. Plumb your nitrous supply line to the **IN** side of you nitrous solenoid.
6. Plumb the 4AN to 3AN hoses to the nitrous plate and insert the appropriate baseline jetting.
7. Proceed to the electrical system section.

2.6 Electrical System

Refer to Figure 16 and procedures in this section for electrical system installation.

WARNING! Death or injury may occur from working on a charged electrical system.

1. Disconnect the car battery at the ground cable (if not already done).
2. Install the NOS arming switch in the vehicle interior, within easy reach of the driver.
3. Install the wiring relay in the engine compartment near the battery. The relay's orange wire should reach the battery (+) terminal.
4. Connect the orange relay wire (with fuse) to the battery (+) terminal.
5. Connect one wire from each solenoid together. Join the solenoid wires to the blue relay wire.
6. Connect the green relay wire to a good chassis ground.

7. Connect the red relay wire to either terminal on the microswitch.
8. Connect the other terminal on the microswitch to the center terminal on the arming switch.
9. Connect the terminal (away from the LED) on the arming switch to a switched +12 volt power source.
10. Connect the terminal (on the side of the LED) of the arming switch to the ground.
11. Reconnect the battery.

CAUTION: Make certain the nitrous bottle is closed and the fuel supply line is not connected. Failure to comply may result in the intake manifold being filled with nitrous and/or fuel creating a potential engine explosion on start up.

12. Temporarily ground the open lead of the nitrous solenoid.
13. Turn the ignition key to the ON position (DO NOT start engine).
14. Turn the arming switch on.
15. Hold the throttle wide open. You should hear a clicking noise if the nitrous solenoid is activated correctly. If no noise is heard, check all the wiring connections and the wiring schematic.
16. Disconnect the grounded wire of the nitrous solenoid and connect the open lead of the fuel solenoid to ground
17. Turn ignition key to ON position (DO NOT start engine).
18. Turn the arming switch on.
19. Hold the throttle wide open. You should hear a clicking noise if the fuel solenoid is activated correctly. If no noise is heard, check all the wiring connections and the wiring schematic.
20. Connect the remaining solenoid wire from each solenoid to ground.

Figure 16 General Electric Wiring Diagram

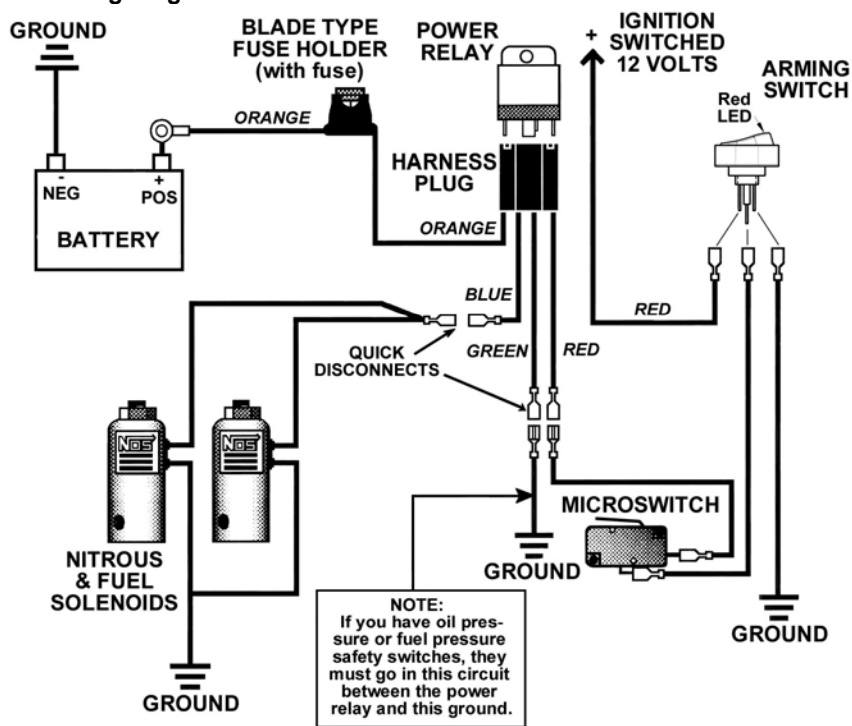

WIRING COLOR KEY	
ORANGE	TO BATTERY POSITIVE (+) TERMINAL
BLUE	TO ONE WIRE FROM EACH SOLENOID
GREEN	TO GROUND
RED	TO IGNITION SWITCHED + 12V THROUGH MICROSWITCH AND ARMING SWITCH

2.8 Testing for Proper Operation without Nitrous Bottle Hook Up

1. Connect the battery and prime the fuel system by cycling the ignition switch from OFF to ON and back to OFF waiting 10 seconds for each interval. Start the engine and check for leaks in the main fuel and secondary system: i.e. fuel injector, fuel supply line to the fuel solenoid, fuel quick disconnect to the fuel rail, etc.
2. Check the WOT switch. These are tested under WOT condition and listening for the clicking sound when the solenoids are activated. WOT condition should be tested in a safe open road area and within legal driving limits. A small lamp can be used to indicate solenoid operation if the engine application does not allow listening for solenoid activation.
3. Make sure a filled nitrous bottle is **NOT open or connected** when performing all of these tests. If it is, engine damage might occur. The nitrous solenoid ground should be disconnected as well (would be a vacuum leak when activated with nothing attached to the other end).
4. Start the engine and let it run until reaching normal operating temperature.
5. Once in a safe open road area (within legal driving limits) and with the arming switch turned "ON" (it should light up), move the gas pedal to the floor. As soon as WOT condition is reached you should hear the solenoid click on. At this time, fuel enrichment through the plate should be supplied the engine. This will make the engine very rich. This verifies proper functioning of the system. Do not run the vehicle like this for an excessive period of time. When you let the pedal back up, the solenoids should click off. If proper functioning does not occur, call the NOS technical service department and troubleshoot the system.

2.9 Preparing for Operation

1. Install a fully charged nitrous bottle. The pressure gauge should read 900-1000 psi at operating temperature/pressure.
2. Connect the nitrous solenoid ground.
3. Start the engine and open the nitrous bottle valve.

NOTE: There should be no change in the engine idle speed or exhaust tone. If either changes, refer to Appendix A, Troubleshooting Guide.

4. Inspect the nitrous lines and fittings for leaks.
5. When you want to activate the nitrous, turn on the arming switch and it should light up. When the throttle is pressed wide open, the nitrous will automatically activate. The nitrous pressure should always be between 900 and 1000 PSI. If it is lower than this, lesser performance can result.

WARNING! Never activate nitrous with the vehicle in "NEUTRAL" or "PARK"!

WARNING! Never activate nitrous at engine speeds below 3000 RPM, or engine damage may result!

WARNING! SEVERE ENGINE DAMAGE MAY OCCUR IF NITROUS IS ACTIVATED WHILE TRACTION CONTROL DEVICES ARE ENABLED. TRACTION CONTROL DE-ACTIVATION MUST BE CYCLED EVERY TIME THE IGNITION SWITCH IS CYCLED.

6. ENJOY!

Chapter 3 Tuning

Table 2 Tuning Suggestions for NOS Kit Number 05168NOS

Configuration	N ₂ O Jetting	Fuel Jetting	Spark Plugs
75 HP	41	26	NGK TR6 or Autolite 103
100 HP*	51	31	NGK TR6 or Autolite 103
125 HP*	55	35	NGK TR6 or Autolite 103
150 HP*	63	38	NGK TR6 or Autolite 103

*Included in kit

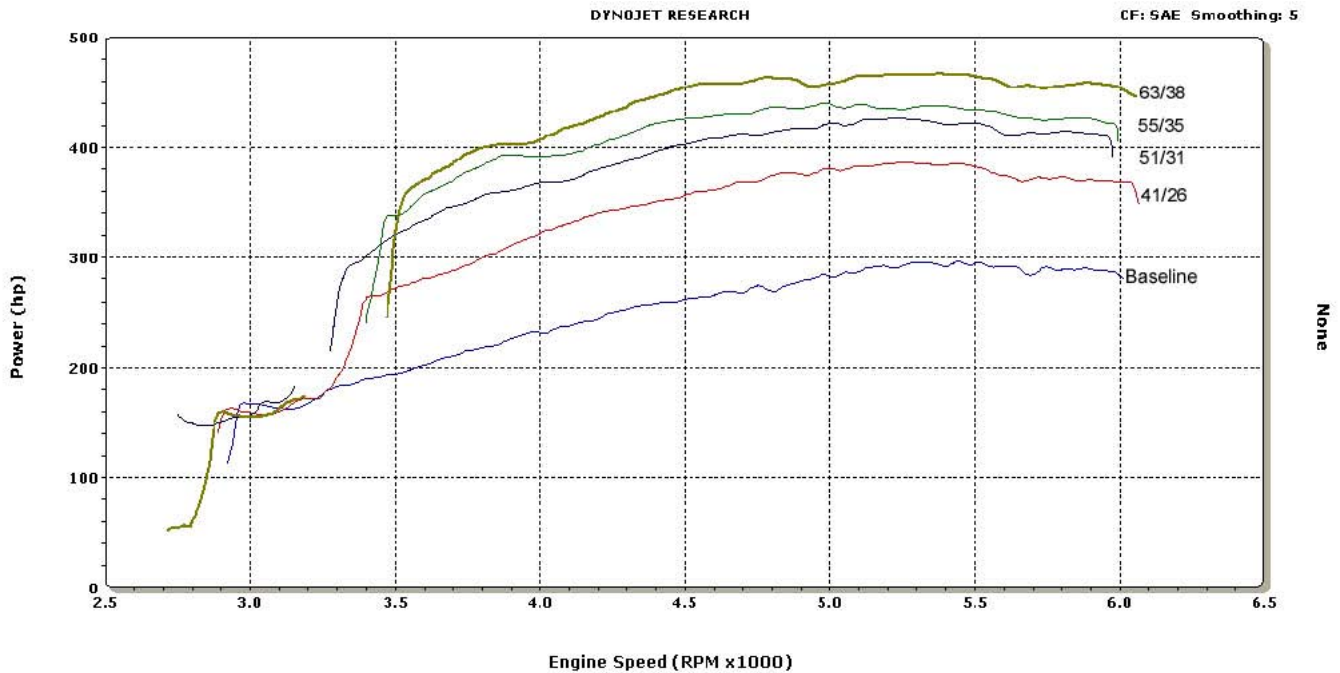

Chapter 4 Determining Optimum System Performance

The jetting combinations included in your 05168NOS kit are intended to generate power gains of 100-125 HP. These combinations are designed to be used with 950 psi of nitrous bottle pressure and 43 psi of flowing fuel pressure. Spark plug inspection and/or the use of a wide-band O₂ sensor can determine optimum system performance. Inspection of the spark plugs should be done on a consistent basis.

1. Perform a dynamometer pull or a full throttle pass down the racetrack. Note the power reading or vehicle mph (not e.t.). Examine the spark plugs for an indication of lean or rich nitrous/fuel conditions (refer to Figure 17 for tips on reading the spark plugs). For this application, the air/fuel mixtures at WOT tend to be very rich in stock form. You may wish to examine a plug after a NO-nitrous pass or dyno pull for comparison purposes.

CAUTION! Terminate test immediately if pinging, knocking, detonation is noticed during the test. If engine does not pull hard (expected HP or torque gains are not observed), terminate test and investigate before continuing.

- 1A. If spark plugs appear to be excessively rich, decrease the fuel jet size 1 step (ex. 28 to 26 or 26 to 24).
- 1B. If spark plugs appear to be excessively lean, increase the fuel jet size 1 step.
- 1C. If spark plugs have a "like new" appearance on the porcelain and electrode, do not make a fuel jetting change.

2. Repeat these steps until the desired mixture is obtained.

How to Read Spark Plugs from a Nitrous Oxide Injected Engine

A. Correct Timing, Mixture, and Spark Plug Heat Range

The ground strap retains a "like new" appearance. The edges are crisp, with no signs of discoloration. The porcelain retains a clear white appearance with no "peppering" or spotting.

B. Excessively Rich Mixture

The porcelain may be fuel stained, appearing brown or black. In extreme cases, the ground strap, electrode, and porcelain may be damp with gasoline, or smell of fuel.

C. Detonation

The edges of the ground strap may become rounded. The porcelain has the appearance of being sprinkled with pepper, or may have aluminum speckles. During heavy detonation, the ground strap tip may burn off. This phenomenon can result from excessive ignition timing, too high a heat range spark plug, inadequate fuel octane, or excessively lean mixture.

D. Excessively Lean Mixture

The edges of the ground strap may become rounded. Under moderate overheating, the tip of the ground strap can discolor, usually turning purple, or the entire ground strap can become discolored.

Figure 17 Spark Plug Condition

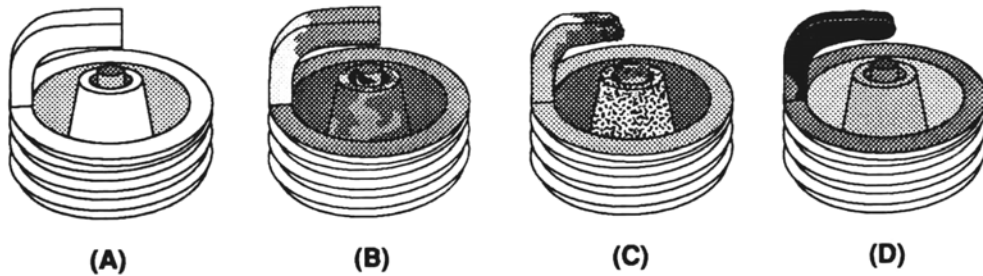

Chapter 5 Alternate Sensor, Actuator, and Switch Components

1. In some racing applications, “pushbutton solenoid” activation is preferred. In such instances, the solenoid is connected to ground via a pushbutton momentary switch P/N 15601NOS. For information on wiring options, please call **NOS Technical Support at 1-866-GOHOLLEY**.
2. Almost all multi-point fuel injection systems are provided with throttle position sensors. NOS has throttle position sensor controllers that activate the solenoids, according to the sensor voltage output. This form of solenoid activation procedure is commonly referred as “TPS activation”. Such devices are more accurate than the microswitch. For P/Ns on TPS switches and information on wiring options, please call **NOS Technical Support at 1-866-GOHOLLEY**.
3. NOS offers fuel pressure safety switches. These switches only allow the nitrous and fuel solenoid to be activated, if a safe fuel pressure is existent in the enrichment fuel supply system. For information on pressure safety switches and information on wiring options, please call **NOS Technical Support at 1-866-GOHOLLEY**.
4. Activation of nitrous at low RPM levels can be detrimental to the engine performance and engine life. The RPM window activation switch only allows the nitrous and fuel solenoid to be activated if a safe RPM value has been reached. Some factory engine control units cut off the ignition if a maximum RPM level is reached. Although the engine is still at WOT and the solenoids are activated no nitrous and fuel is combusted. When the engine reaches safe RPM levels ignition is restored but excess fuel and nitrous are present in the manifold. Some applications may even cut the fuel injector to limit engine RPM. Because the engine is at WOT, the nitrous solenoid is still open thus generating an extreme lean condition. Under both conditions engine damage might occur. The RPM window activation switch cuts off the supply of fuel and nitrous until safe RPM levels are reached. The low and high RPM values can be trimmed according to the application. For information on pressure safety switches and wiring options, please call **NOS Technical Support at 1-866-GOHOLLEY**.

Chapter 6 Routine Maintenance

6.1 Nitrous Solenoid Filter

When nitrous bottles are refilled, they can become contaminated with debris if the refiller does not have adequate filtration in his transfer pump mechanism. Contaminants in the bottle will eventually become lodged in the nitrous solenoid filter fitting.
Call 1-800-99-REFILL (1-800-997-3345) for bottle refill location information.

You should periodically (after every 20-30 pounds of nitrous usage) examine the mesh in the nitrous filter for debris.

To clean the filter, follow the following steps:

1. Close the valve on the nitrous bottle.
2. Empty the main nitrous feed line.
3. Disconnect the main nitrous feed line from the nitrous solenoid.
4. Remove the nitrous filter fitting from the nitrous solenoid.
5. Remove **all** Teflon paste debris from the solenoid inlet port threads and from the nitrous solenoid filter pipe threads.
6. Examine the mesh in the nitrous filter fitting for contaminants. Blow out debris with compressed air, if necessary.
7. Apply fresh Teflon paste to the nitrous filter pipe threads. Reinstall the filter in the nitrous solenoid.
8. Reconnect the main nitrous supply line to the nitrous solenoid.

6.2 Nitrous Solenoid Plunger

6.2.1 General Information

The seals used in NOS nitrous solenoid plungers are constructed from materials which are designed to be used with nitrous oxide. When kept free from fuel contaminants or from overpressurization, they should provide trouble free performance.

You should periodically (after every 20-30 pounds of nitrous usage) examine the seal in the nitrous solenoid plunger. The seals used in NOS nitrous solenoid plungers are designed to work at pressures up to 1100 psi. Exposing the plunger to excessive pressure (whether the vehicle is sitting or in-use) can result in the seal in the plunger swelling or in extreme cases disintegrating.

NOTE: The seals are designed so that if they fail due to overpressurization, they will not leak, the valve will just fail to flow nitrous oxide.

Swelling of the nitrous solenoid plunger seal will reduce nitrous flow (causing an excessively rich nitrous/fuel condition and a loss of power).

6.2.2 Nitrous Solenoid Plunger Disassembly and Inspection

1. Close the valve on the nitrous bottle.
2. Empty the main nitrous supply line.
3. Remove the retaining nut from the nitrous solenoid.
4. Remove the coil and housing from the nitrous solenoid base.
5. Unscrew the stem from the nitrous solenoid base. Do this by double nutting the stem, or by using a solenoid stem removal tool (NOS P/N 16666-S). **Do not use pliers on the solenoid stem. Damage to the stem will result.**
6. Remove the stem, spring, and plunger from the solenoid base.
7. Examine the plunger seal for swelling. The seal surface should be flat, except for a small circular indentation in the center of the seal;

A fuel-contaminated seal will protrude from the plunger and be dome-shaped. A fuel-contaminated seal may return to its original shape if left out in the fresh air for several days. It may then be returned to service.

A seal, which has been over-pressurized, may be dome-shaped, or the sealing surface may be flat with the seal protruding out of the plunger. A dome-shaped seal may return to its original shape if left out in the fresh air for several days. It may then be returned to service. A seal, which is flat, but protrudes from the plunger body has probably failed internally and should be replaced.

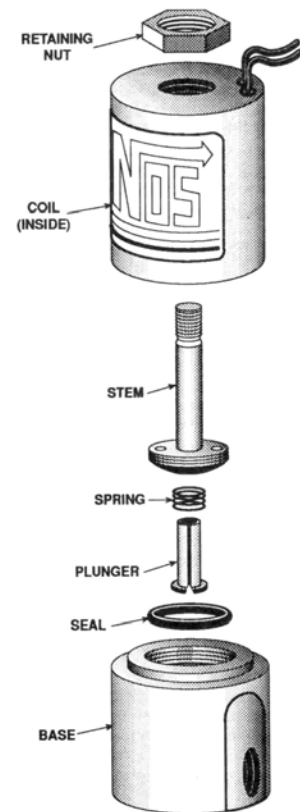

Exploded View of a Typical Solenoid

Appendix A Troubleshooting Guide

The troubleshooting chart on the following pages should help determine and rectify most problems with your installed NOS system. If you still need assistance determining or fixing problems, call NOS Technical Support Department at 1-866-GOHOLLEY or fax to 1-270-781-9772.

PROBLEM	POSSIBLE CAUSES	DIAGNOSTIC PROCEDURE	CORRECTIVE ACTION
No change in engine speed when the fuel solenoid is activated (Preparing for Operation—Chapter 6).	System wired incorrectly.	Compare wiring to schematic.	Wire per instructions.
	Restricted fuel line.	Inspect fuel line for restrictions (crimped or plugged).	Remove restrictions.
	Malfunctioning fuel solenoid.	Turn arming switch ON. Activate microswitch. Solenoid should make “clicking” noise.	Repair/replace solenoid.
Change in engine speed when nitrous bottle valve is opened (Preparing for Operation—Chapter 6).	Malfunctioning nitrous solenoid.	Remove and inspect solenoid.	Repair/replace solenoid.
Engine runs rich when system is activated.	Bottle valve not fully opened.	Check bottle valve.	Open valve fully.
	Bottle mounted improperly.	Check bottle orientation.	Mount bottle properly.
	Plugged nitrous filter.	Inspect filter.	Clean/replace filter.
	Low bottle pressure.	Check bottle temperature.	Set bottle temperature to 80° to 85°F.
	Inadequate nitrous supply.	Weigh bottle.	Fill bottle. 1-800-997-3345 for refills nearest you.
	Mismatched N ₂ O/fuel jetting.	Compare jetting to recommended values.	Install correct jets.
	Excessive fuel pressure.	Install fuel pressure gauge, such as NOS P/N 15931NOS, in the fuel line. Measure the pressure during acceleration, with the system activated.	Regulate pressure down, or install smaller fuel jetting.
	Loose nitrous solenoid wiring.	Inspect the solenoid wiring.	Repair wiring.
Malfunctioning nitrous solenoid.	WARNING: <i>Solenoid discharges nitrous at a high rate. Don't inhale nitrous; death may occur. Skin contact may cause frostbite.</i> Close bottle valve. Disconnect the solenoid outlet port. Disconnect the solenoid (+) lead. Open the nitrous bottle valve. Briefly connect the +12V to the solenoid. Solenoid should discharge N ₂ O at a high rate.	Rebuild solenoid.	
No change in performance when system is activated.	System wired incorrectly.	Compare nitrous wiring to schematic.	Wire system per instr.
	Loose ground wire(s).	Connect 12V test light to battery (+) terminal. Check for continuity at grounds noted in schematic.	Tighten/repair loose ground(s).
	Malfunctioning pushbutton.	Turn bottle valve off. Turn arming switch on. Connect 12V test light to battery (-). Turn pushbutton switch ON. Check for continuity at pushbutton output pole.	Replace pushbutton.
	No power to arming switch.	With vehicle ignition on, connect 12V test light to battery (-) terminal. Check for power at pole #1 on arming switch.	Repair wiring.
	Malfunctioning arming switch.	With vehicle ignition on, turn arming switch ON. Connect 12V test light to battery (-) terminal. Check for power at red wire on arming switch.	Replace arming switch.
	Malfunctioning throttle microswitch.	Temporarily disconnect power relay green wire from microswitch. Connect 12V test light to battery (+) terminal. Manually set microswitch ON. Check for continuity at microswitch positive terminal (see wiring schematic).	Replace throttle microswitch.
	Overly rich fuel condition.	Check for black smoke or backfiring through exhaust with system activated.	Install smaller fuel jet or decrease fuel pressure.

Engine detonates mildly when system is activated.	Inadequate octane fuel.		Use higher octane fuel; up to 116VPC-16.
	Spark plug heat range too high.		Reduce spark plug heat range (maximum 2 steps).
	Too much nitrous flow.		Reduce nitrous jetting.
Engine detonates heavily when system is activated.	Inadequate fuel delivery due to: Plugged fuel filter.	Inspect fuel filter.	Clean or replace filter.
	Crimped fuel line.	Inspect fuel line.	Replace crimped line.
	Weak fuel pump.	Install fuel pressure gauge, such as NOS P/N 15931NOS. Run engine under load at wide-open throttle, with system activated.	Repair/replace fuel pump.
High rpm misfire when system is activated.	Excessive spark plug gap.	Inspect spark plugs.	Set spark plug gap at 0.030" to 0.035".
	Weak ignition/ignition component failure.	Inspect components (plug wires, distributor cap, etc.)	Replace worn components.
Surges under acceleration when system is activated.	Inadequate supply of nitrous.	Check bottle weight.	Replace with full bottle.
	Bottle mounted incorrectly.	Compare bottle position and orientation to instructions.	Mount or orient bottle correctly.

Nitrous Oxide Accessories

NOS systems are calibrated for optimum performance with a bottle pressure of 900-950 psi. The pressure will change with temperature. Heater kits are thermostatically controlled to keep the bottle near 85° F to provide correct pressure. **Bottle Heater (P/N 14164NOS)** is available for 10 & 15 lb. bottles.

Insulating the bottle helps maintain pressure by keeping heat in the bottle when it's cold, or heat out when it's hot outside. The blankets are made of a rugged, easily cleaned Nylon outer shell with insulation. It's also an excellent "dress up" accessory and perfect for "covering" battle-scarred bottles. **Bottle Blanket (P/N 14165NOS)** is a 7" diameter blanket for the 10 lb. bottle.

#10 Bottle Heater P/N 14169 NOS



#10 Bottle Blanket P/N 14165NOS



Remote Bottle Valve P/N 14168NOS



The **Remote Bottle Valve, P/N 14168NOS** is the perfect convenience accessory— this opener allows you to open and close your nitrous bottle from the driver's compartment with the flip of a switch—no more trips to the trunk. The complete kit includes hardware and installation instructions.

The **Nitrous Pressure Gauges**, P/N 15910NOS (-4AN lines) or P/N 15912NOS (-6AN lines) [0-1500 PSIG] are designed to provide accurate ($\pm 2\%$ of full scale) readings of fuel pressure in carbureted applications.

The **Fuel Pressure Gauges**, P/N 15906NOS [0-120 PSIG] and P/N 15900NOS [0-15 PSIG] are engineered to provide accurate ($\pm 2\%$ of full scale) readings for high and low fuel pressure applications.

Nitrous & Fuel Pressure Gauges



NOS Technical Support
Toll-Free Phone: 1-866-GOHOLLEY
Phone: 1-270-781-9741
Fax: 1-270-781-9772

**For online help, please check the Tech
Service section of our website:
www.holley.com**

**For refill information:
1-800-99-REFILL (1-800-997-3345)**

199R10361
Date: 5-11-05