

Please read and save these instructions. Read through this owner's manual carefully before using product. Protect yourself and others by observing all safety information, warnings, and cautions. Failure to comply with instructions could result in personal injury and/or damage to product or property. Please retain instructions for future reference.



4-1/2" ANGLE GRINDER

FOR CUSTOMER SERVICE

Technical Question?

CALL 1-866-458-2472
customerservice@oem-tools.com

UNPACKING

After unpacking unit, inspect carefully for any damage that may have occurred during transit. Check for loose, missing, or damaged parts. If any damage is observed, a shipping damage claim must be filed with carrier. Do not use the OEMTOOLS™ Angle Grinder if broken, bent, cracked or damaged parts (including labels) are noted. Any Angle Grinder that appears damaged in any way, operates abnormally or is missing parts should be removed from service immediately. If you suspect that the Angle Grinder was subjected to shock load (a load that was dropped suddenly, unexpectedly, etc.), immediately discontinue use until it has been checked by a factory authorized service center.



⚠ WARNING

The following safety information is provided as a guideline to help you operate your Angle Grinder under the safest possible conditions. Any tool or piece of equipment can be potentially dangerous to use when safety or safe handling instructions are not known or not followed. The following safety instructions are to provide the user with the information necessary for safe use and operation. Please read and retain these instructions for the continued safe use of your tool. Failure to follow instructions listed below may result in serious injury. In addition, make certain that anyone who uses the equipment understands and follows these safety instructions as well.

Explanation of Safety Signal Words

⚠ WARNING : Indicates a potentially hazardous situation which, if not avoided, could result in death or serious injury.

⚠ CAUTION : Indicates a potentially hazardous situation which, if not avoided, may result in minor or moderate injury.

CAUTION : Used without the safety alert symbol indicates a potentially hazardous situation which, if not avoided, may result in property damage.

NOTES : Provide clarity and helpful information.

Thank you very much for choosing an OEMTOOLS™ Product!

For future reference, please register your new tool at www.oem-tools.com and complete the owner's record below:

Model: _____ **Purchase Date:** _____

Save the receipt, warranty and these instructions. It is important that you read the entire manual to become familiar with this product before you begin using it. This tool is designed for certain applications only. OEMTOOLS™ cannot be responsible for issues arising from modification. We strongly recommend this tool is not modified and/or used for any application other than that for which it was designed. If you have any questions relative to a particular application, DO NOT use the tool until you have first contacted customer service to determine if it can or should be performed on the product.



4-1/2" ANGLE GRINDER

POWER TOOL SAFETY

▲ WARNING

Read all safety warnings and instructions. Failure to follow the warnings and instructions may result in electric shock, fire and/or serious injury.

Save all warnings and instructions for future reference.

WORK AREA SAFETY

1. Keep work area clean and well lit. Cluttered or dark areas invite accidents.
2. Do not operate power tools in explosive atmospheres, such as in the presence of flammable liquids, gases or dust. Power tools create sparks which may ignite the dust or fumes.
3. Keep children and bystanders away while operating a power tool. Distractions can cause you to lose control.

ELECTRICAL SAFETY

1. Power tool plugs must match the outlet. Never modify the plug in any way. Do not use any adapter plugs with earthed (grounded) power tools. Unmodified plugs and matching outlets will reduce risk of electric shock.
2. Avoid body contact with earthed or grounded surfaces such as pipes, radiators, ranges and refrigerators. There is an increased risk of electric shock if your body is earthed or grounded.
3. Do not expose power tools to rain or wet conditions. Water entering a power tool will increase the risk of electric shock.
4. Do not abuse the cord. Never use the cord for carrying, pulling or unplugging the power tool. Keep cord away from heat, oil, sharp edges or moving parts. Damaged or entangled cords increase the risk of electric shock.
5. When operating a power tool outdoors, use an extension cord suitable for outdoor use. Use of a cord suitable for outdoor use reduces the risk of electric shock.
6. If operating a power tool in a damp location is unavoidable, use a residual current device (RCD) protected supply. Use of a ground fault circuit interrupter (GFCI) reduces the risk of electric shock.

PERSONAL SAFETY

1. Stay alert, watch what you are doing and use common sense when operating a power tool. Do not use a power tool while you are tired or under the influence of drugs, alcohol or medication. A moment of inattention while operating power tools may result in serious personal injury.
2. Use personal protective equipment. Always wear eye protection. Protective equipment such as dust mask, non-skid safety shoes, hard hat, or hearing protection used for appropriate conditions will reduce personal injuries.
3. Prevent unintentional starting. Ensure the switch is in the off-position before connecting to power source and/or battery pack, picking up or carrying the tool. Carrying power tools with your finger on the switch or energizing power tools that have the switch on invites accidents.
4. Remove any adjusting key or wrench before turning the power tool on. A wrench or a key left attached to a rotating part of the power tool may result in personal injury.
5. Do not overreach. Keep proper footing and balance at all times. This enables better control of the power tool in unexpected situations.
6. Dress properly. Do not wear loose clothing or jewelry. Keep your hair, clothing and gloves away from moving parts. Loose clothes, jewelry or long hair can be caught in moving parts.
7. If devices are provided for the connection of dust extraction and collection facilities, ensure these are connected and properly used. Use of dust collection can reduce dust-related hazards.

POWER TOOL USE AND CARE

1. Do not force the power tool. Use the correct power tool for your application. The correct power tool will do the job better and safer at the rate for which it was designed.
2. Do not use the power tool if the switch does not turn it on and off. Any power tool that cannot be controlled with the switch is dangerous and must be repaired.
3. Disconnect the plug from the power source and/or the battery pack from the power tool before making any adjustments, changing accessories, or storing power tools. Such preventive safety measures reduce the risk of starting the power tool accidentally.
4. Store idle power tools out of the reach of children and do not allow persons unfamiliar with the power tool or these instructions to operate the power tool. Power tools are dangerous in the hands of untrained users.
5. Maintain power tools. Check for misalignment or binding of moving parts, breakage

of parts and any other condition that may affect the power tool's operation. If damaged, have the power tool repaired before use. Many accidents are caused by poorly maintained power tools.

6. Keep cutting tools sharp and clean. Properly maintained cutting tools with sharp cutting edges are less likely to bind and are easier to control.
7. Use the power tool, accessories and tool bits etc. in accordance with these instructions, taking into account the working conditions and the work to be performed. Use of the power tool for operations different from those intended could result in a hazardous situation.

SERVICE

Have your power tool serviced by a qualified repair person using only identical replacement parts. This will ensure that the safety of the power tool is maintained.

▲ WARNING

1. Know your Angle Grinder. Do not plug the Angle Grinder into the power source until you have read and understand this Instruction Manual. Learn the tool's applications and limitations, as well as the specific potential hazards related to this tool. Following this rule will reduce the risk of electric shock, fire, or serious injury.
2. Always wear eye protection. Any power tool can throw foreign objects into your eyes and cause permanent eye damage. ALWAYS wear safety goggles (not glasses) that comply with ANSI safety standard Z87.1. Everyday glasses have only impact resistant lenses. They ARE NOT safety glasses.
3. Glasses or goggles not in compliance with ANSI Z87.1 could cause serious injury when they break.
4. This power tool is intended to function as a grinder and cut-off tool. Read all safety warnings, instructions, illustrations and specifications provided with this power tool. Failure to follow all instructions listed below may result in electric shock, fire and/or serious injury.
5. Do not use accessories which are not specifically designed and recommended by the tool manufacturer. Just because the accessory can be attached to your power tool, it does not ensure safe operation.
6. The rated speed of the accessory must be at least equal to the maximum speed marked on the power tool. Accessories running faster than their RATED SPEED can break and fly apart.
7. The outside diameter and the thickness of your accessory must be within the capacity rating of your Angle Grinder. Incorrectly sized accessories cannot be adequately guarded or controlled.
8. Always follow the instructions related to the use of blotters, correct use of flanges and guards, and proper storage of the accessory outlined by the manufacturer of the accessory.
9. The arbor size of wheels, flanges, backing pads or any other accessory must properly fit the spindle of the Angle Grinder tool. Accessories with arbor holes that do not match the mounting hardware of the Angle Grinder will run out of balance, vibrate excessively and may cause loss of control.
10. Do not use a damaged accessory. Before each use inspect the accessory for chips and cracks. If the Angle Grinder or accessory is dropped, inspect them for damage or install an undamaged accessory. After inspecting and installing the accessory, position yourself and bystanders away from the plane of the rotating accessory and run the power tool at maximum no-load speed for one minute. Damaged accessories will normally break apart during this test time.
11. Wear personal protective equipment. Depending on the application, use a face shield, safety goggles or safety glasses. As appropriate, wear a dust mask, hearing protectors, gloves and workshop apron capable of stopping small abrasive or workpiece fragments. The eye protection must be capable of stopping flying debris generated by various operations. The dust mask or respirator must be capable of filtering particles generated by your operation. Prolonged exposure to high intensity noise may cause hearing loss.
12. Keep bystanders a safe distance away from the work area. Anyone entering the work area must wear personal protective equipment. Fragments of the workpiece or of a broken accessory may fly away and cause injury beyond the immediate area of operation.
13. Hold the Angle Grinder tool by insulated gripping surfaces only when performing an operation where the cutting accessory may contact hidden wiring or the angle grinder's cord. The cutting accessory contacting a "live" wire may make exposed metal parts of the angle grinder "live" and shock the operator.
14. Position the cord clear of the spinning accessory. If you lose control, the cord may be cut or snagged and your hand or arm may be pulled into the spinning accessory.



4-1/2" ANGLE GRINDER

- Never lay the Angle Grinder down until the accessory has come to a complete stop. The spinning accessory may grab the surface and pull the angle grinder out of your control.
- Do not run the Angle Grinder while carrying it at your side. Accidental contact with the spinning accessory could snag your clothing, pulling the accessory into your body.
- Regularly clean the angle grinder's air vents. The motor's fan will draw the dust inside the housing and excessive accumulation of powdered metal may cause electrical hazards.
- Do not operate the Angle Grinder near flammable materials. Sparks could ignite these materials.
- Do not use accessories that require liquid coolants. Using water or other liquid coolants may result in electrocution or shock.

KICKBACK AND RELATED WARNINGS

- Kickback is a sudden reaction to a pinched or snagged rotating wheel, backing pad, brush or any other accessory. Pinching or snagging causes rapid stalling of the rotating accessory which in turn causes the uncontrolled angle grinder to be forced in the direction opposite of the accessory's rotation at the point of the binding.
- For example, if an abrasive wheel is snagged or pinched by the workpiece, the edge of the wheel that is entering into the pinch point can dig into the surface of the material causing the wheel to climb out or kick out.
- The wheel may either jump toward or away from the operator, depending on direction of the wheel's movement at the point of pinching. Abrasive wheels may also break under these conditions.
- Kickback is the result of power tool misuse and/or incorrect operating procedures or conditions and can be avoided by taking proper precautions as given below.
- Maintain a firm grip on the Angle Grinder and position your body and arm to allow you to resist kickback forces. Always use the auxiliary handle for maximum control over kickback or torque reaction during start-up. The operator can control torque reactions or kickback forces if proper precautions are taken.
- Never place your hand near the rotating accessory. The accessory may kickback over your hand.
- Do not position your body in the area where the angle grinder will move if kickback occurs. Kickback will propel the tool in the direction opposite to the wheel's movement at the point of snagging.
- Use special care when working corners, sharp edges etc. Avoid bouncing and snagging the accessory. Corners, sharp edges or bouncing have a tendency to snag the rotating accessory and cause loss of control or kickback.
- Do not attach a saw chain woodcarving blade or toothed saw blade. Such blades create frequent kickback and loss of control.

ADDITIONAL WARNINGS FOR GRINDING

- Use only wheel types that are recommended for your Angle Grinder and the specific guard designed for the selected wheel. Wheels for which the power tool was not designed cannot be adequately guarded and are unsafe.
- The guard must be securely attached to the Angle Grinder and positioned for maximum safety, so the least amount of wheel is exposed towards the operator. The guard helps to protect operator from broken wheel fragments and accidental contact with the wheel.
- Wheels must be used only for recommended applications. For example: do not grind with the side of cut-off wheel. Abrasive cut-off wheels are intended for peripheral grinding and side forces applied to these wheels may cause them to shatter.
- Always use undamaged wheel flanges that are of correct size and shape for your selected wheel. Proper wheel flanges support the wheel thus reducing the possibility of wheel breakage. Flanges for cut-off wheels may be different from grinding wheel flanges.
- Do not use worn down wheels from larger power tools. Wheels intended for a larger Angle Grinder are not suitable for the higher speed of a smaller tool and may burst.

ADDITIONAL SAFETY WARNINGS SPECIFIC FOR ABRASIVE CUTTING-OFF OPERATIONS

- Do not jam the cut-off wheel or apply excessive pressure. Do not attempt to make an excessive depth of cut. Overstressing the wheel increases the loading and susceptibility to twisting or binding of the wheel in the cut and the possibility of kickback or wheel breakage.
- Do not position your body in line with and behind the rotating wheel. When the wheel, at the point of operation, is moving away from your body, the possible kickback may propel the spinning wheel and the power tool directly at you.
- When wheel is binding or when interrupting a cut for any reason, switch off

- the power tool and hold the power tool motionless until the wheel comes to a complete stop.
- Never attempt to remove the cut-off wheel from the cut while the wheel is in motion otherwise kickback may occur. Investigate and take corrective action to eliminate the cause of wheel binding.
- Do not restart the cutting operation in the workpiece. Let the wheel reach full speed and carefully reenter the cut. The wheel may bind, walk up or kickback if the power tool is restarted in the workpiece.
- Support panels or any oversized workpiece to minimize the risk of wheel pinching and kickback. Large workpieces tend to sag under their own weight. Supports must be placed under the workpiece near the line of cut and near the edge of the workpiece on both sides of the wheel.
- Use extra caution when making a "pocket cut" into existing walls or other blind areas. The protruding wheel may cut gas or water pipes, electrical wiring or objects that can cause kickback.

▲ WARNING

SAFETY WARNINGS SPECIFIC FOR SANDING OPERATIONS

Do not use excessively oversized sanding disc paper. Follow manufacturer's recommendations when selecting sanding paper. Larger sanding paper extending beyond the sanding pad presents a laceration hazard and may cause snagging, tearing of the disc or kickback.

SAFETY WARNINGS SPECIFIC FOR POLISHING OPERATIONS

Do not allow any loose portion of the polishing bonnet or its attachment strings to spin freely. Tuck away or trim any loose attachment strings. Loose and spinning attachment strings can entangle your fingers or snag on the workpiece.

SAFETY WARNINGS SPECIFIC FOR WIRE BRUSHING OPERATIONS

- Be aware that wire bristles are thrown by the brush even during ordinary operation.
- Do not overstress the wires by applying excessive load to the brush. The wire bristles can easily penetrate light clothing and/or skin.
- If the use of a guard is recommended for wire brushing, do not allow any interference of the wire wheel or brush with the guard. Wire wheel or brush may expand in diameter due to work load and centrifugal forces.

IMPORTANT SAFETY INSTRUCTIONS

The warnings, precautions, and instructions discussed in this manual cannot cover all possible conditions and situations that may occur. The operator must understand that common sense and caution are factors which cannot be built into this product, but must be supplied by the operator.

DISPOSAL

At the end of the useful life of the OEMTOOLS™ Angle Grinder, dispose of the components according to all state, federal, and local regulations.

SPECIFIC SAFETY RULES

- For your safety, do not plug in your Angle Grinder until you have read and understood this Owner's Manual.
- Always wear eye protection that conforms with CSA requirements or ANSI safety standard Z87.1.
- Always wear gloves to protect your hands from hot sparks.
- Always wear hearing protection and dust mask. Use only in well ventilated areas. Use of personal protective equipment and working in a safe environment will reduce the risk of injury.
- Always keep hands out of the path of the grinding disc. Avoid awkward hand positions where a sudden slip could cause your hand to move into the moving blade.
- To avoid injury from accidental starting, always unplug the angle grinder from the power source before installing or removing grinding discs.
- Grinding disc and guard must be securely attached as described in this Owner's Manual before connecting the grinder to the power source. Failure to do so will increase the risk of serious injury if the grinding disc shatters.
- Make sure the guard is in good condition and securely installed before operating grinder.



4-1/2" ANGLE GRINDER

9. Secure the workpiece. Use clamps or a vice to hold the workpiece when practical. It's safer than using your hand and it frees both hands to operate the tool.
10. **DO NOT** clamp grinder in vise or use as a fixed grinder.
11. Grinding discs must be stored in a dry location to prevent deterioration.
12. Before attaching the grinding disc, inspect it for visible defects. If cracked, chipped or warped do not install it.
13. Use only grinding discs in compliance with ANSI Standard B7.1 and rated for a speed greater than 11,000 RPM.
14. **DO NOT** remove the soft paper in the center of the grinding disc.
NOTE: If this paper has been previously removed, insert some soft rubber or paper between the grinding disc and the disc flange to prevent damage to the grinding disc.
15. **DO NOT** alter or enlarge the center hole of the grinding disc as this could result in breaking it.
16. **DO NOT** over-tighten the clamp nut on the grinding disc. Excessive tightening may cause the disc to crack and possibly shatter during operation.
17. **DO NOT** use the grinder if the disc flange or clamp nut is missing or if the spindle is bent.
18. Check to make sure the power cord and any extension cord are clear of the area to be cut. Contact with "live" wires could shock the operator or cause a fire.
19. Hold tool by insulated gripping surfaces when performing an operation where the tool may contact hidden wiring or its own cord. Contact with a "live" wire will make exposed metal parts of the tool "live" and shock the operator.
20. Always hold the grinder securely with two hands while working and at all times when it is running.
21. Never turn the grinder ON with the grinding disc or any rotating parts touching the work surface.
22. Never cover the air vents in the motor housing with your hands while operating the grinder.

EXTENSION CORD SAFETY

Tool service must be performed only by qualified personnel. Service or maintenance performed by unqualified personnel could result in risk of injury. When servicing a tool, use only identical replacement parts. Follow instructions in the Maintenance section of this manual. Use of unauthorized parts or failure to follow Maintenance instructions may create a risk of electric shock or injury.

⚠ WARNING

Keep the extension cord clear of the working area. Position the cord so it will not get caught on the workpiece, tools or any other obstructions while you are working with the power tool.

Make sure any extension cord used with this tool is in good condition. When using an extension cord, be sure to use one of heavy enough gauge to carry the current the tool will draw. An undersized cord will cause a drop in line voltage resulting in loss of power and overheating.

The table shows the correct size to use according to cord length and nameplate ampere rating. If in doubt, use the next heavier gauge. The smaller the gauge number, the heavier the cord.

Be sure your extension cord is properly wired and in good condition.

Always replace a damaged extension cord or have it repaired by a qualified electrician before using it. Protect your extension cord from sharp objects, excessive heat and damp or wet areas.

Use a separate electrical circuit for your power tools. This circuit must not be less than 14 gauge wire and should be protected with either a 15 AMP time delayed fuse or circuit breaker. Before connecting the power tool to the power source, make sure the switch is in the OFF position and the power source is the same as indicated on the nameplate. Running at lower voltage will damage the motor.

MINIMUM GAUGE (AWG) EXTENSION CORDS (120V USE ONLY)					
Amperage rating		Total length			
More than	Not more than	25' (7.5 m)	50' (15 m)	100' (30 m)	150' (45 m)
0	6	18	16	16	14
6	10	18	16	14	12
10	12	16	16	14	12
12	16	14	12	Not Applicable	

⚠ WARNING

1. To avoid electrical hazards, fire hazards or damage to the tool, use proper circuit protection. This tool is wired at the factory for 110–120 V operation. It must be connected to a 110–120 V 15A time delayed fuse or circuit breaker. To avoid shock or fire, replace power cord immediately if it is worn, cut or damaged in any way.
2. Double insulated tools are equipped with a polarized plug (one blade is wider than the other). This plug will fit in a polarized plug only one way.
3. If the plug does not fit fully into the outlet, reverse the plug. If it still does not fit, contact a qualified electrician to install a polarized outlet. Do not alter the plug in any way. Double insulation eliminates the need for the three-prong grounded power cord and grounded power supply system.
4. Avoid body contact with grounded surfaces such as pipes, radiators, ranges and refrigerators. There is a risk of electric shock if your body is grounded.
5. **DO NOT** expose power tools to rain or wet conditions. Water entering the power tool will increase the risk of electric shock.
6. **DO NOT** abuse the cord. Never use the cord to carry the tool or pull the plug from an outlet. Keep cord away from heat, oil, sharp edges or moving parts. Replace damaged cords immediately. Damaged cords increase the risk of electric shock.
7. When operating a power tool outdoors, use an outdoor extension cord marked "WA" or "W". These cords are rated for outdoor use and reduce the risk of electric shock.
8. Avoid accidental starting. Be sure the switch is OFF before plugging in. Carrying tools with your finger on the switch or plugging in tools that have the switch ON invites accidents.

TOOL USE AND CARE

1. Use clamps or another practical way to secure and support the workpiece to a stable platform. Holding the work by hand or against your body is unstable and may lead to loss of control.
2. **DO NOT** force the tool. Use the correct tool for your application. The correct tool will do the job better and safer at the rate for which it was designed.
3. **DO NOT** use the tool if the power switch does not turn it ON or OFF. Any tool that cannot be controlled with the switch is dangerous and must be repaired.
4. Disconnect the plug from the power source before making any adjustments, changing accessories or storing the tool. Such preventive safety measures reduce the risk of starting the tool accidentally.
5. Check for misalignment or binding of moving parts, breakage of parts and any other condition that may affect the tool's operation. If damaged, have the tool serviced before using. Many accidents are caused by poorly maintained tools.



4-1/2" ANGLE GRINDER

SERVICE

Tool service must be performed only by qualified personnel. Service or maintenance performed by unqualified personnel could result in risk of injury. When servicing a tool, use only identical replacement parts. Follow instructions in the Maintenance section of this manual. Use of unauthorized parts or failure to follow Maintenance instructions may create a risk of electric shock or injury.

PURPOSE

The OEMTOOLS™ Angle Grinder 4-1/2" has an ultra-compact body and is designed for sanding, polishing, smoothing rough areas, grinding and carving in confined spaces.

PRODUCT SPECIFICATIONS

Motor:	6 Amp, 120V, 60Hz
No-Load Speed:	10,500 RPM
Max. Disc Diameter:	4-1/2"
Spindle Threads:	5/8" – 11 UNC
Min. Disc Thickness:	5/32"

OPERATING INSTRUCTIONS

⚠ WARNING

Always disconnect your Angle Grinder from the power source when replacing grinding discs, adjusting the guard, cleaning or when the tool is not in use. Disconnecting the Angle Grinder will prevent accidental starting that could cause serious personal injury.

INSTALLING THE SIDE HANDLE

1. Unplug the Angle Grinder from the power source.
2. Install the side handle (1) by screwing it clockwise into the left side (2) of the gear housing (#3 in Fig. 1).
NOTE: The handle can be installed on either the left or right side of the grinder gear housing, depending upon operator preference (Fig. 6 and 7). The side handle must always be used to prevent loss of control and possible injury.
3. Tighten the side handle securely.

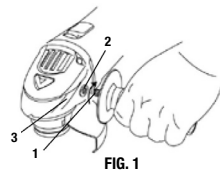

FIG. 1

NOTE: Hand-tighten the side handle. Do not over-tighten.

INSTALLING THE GUARD

⚠ WARNING

The guard must be installed before installing a grinding disc or using the Angle Grinder. Failure to do so could result in serious personal injury.

1. Depress the spindle lock button (1) and rotate the clamp nut (2) until the spindle locks (Fig. 2).
2. Turn the clamp nut counterclockwise and remove it from the spindle.
NOTE: If the clamp nut cannot be loosened by hand, use the wrench (3) provided.
3. Remove the disc flange (4). It will simply pull off the spindle (5).
4. Loosen the guard clamp bolt to allow the guard clamp to expand for installation.
5. Slide the guard clamp (7) over the spindle housing (8) until the detents mate with the groove (9) in the spindle housing (Fig. 3).
NOTE: Rotate the guard so it is positioned correctly depending upon the location of the side handle (Fig. 6 and 7).

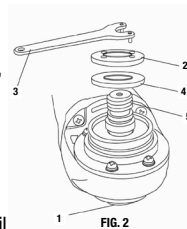

FIG. 2

6. Rotate guard to position it toward the rear of the grinder.
7. Use a #2 Philips® screwdriver to tighten the guard clamp screw (Fig. 4).

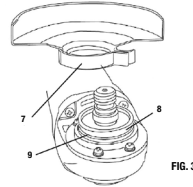

FIG. 3

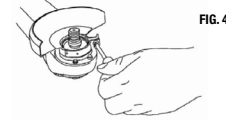

FIG. 4

8. Install the disc flange, making sure it mates with the flats on the spindle.
9. Install the clamp nut finger tight to hold the disc flange in place.

⚠ WARNING INSTALLING A GRINDING DISC

Use correct size grinding disc. Never use a grinding disc thinner than 5/32" (3.9 mm).

1. Depress the spindle lock button (1) and rotate the clamp nut (2) until spindle locks (Fig. 5).
2. Turn the clamp nut counterclockwise and remove it from spindle.

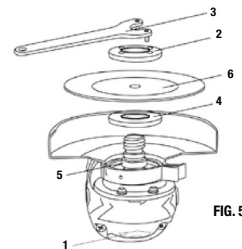

FIG. 5

NOTE: If the clamp nut cannot be loosened by hand, use the wrench (3) provided. **DO NOT** remove the disc flange (4).

3. Make sure the flats on the bottom of disk flange are engaged with the flats on the spindle (5).
4. Place the grinding disc over the spindle with the concave side of the disc (6) facing outward.
5. Screw the clamp nut (2) onto the spindle with the flat side of nut facing up. Fit the raised small diameter portion of the clamp nut into the hole in the grinding disc. Tighten to finger tight only.
6. Depress the spindle lock button and rotate the grinding disc clockwise until the spindle locks.
7. Securely tighten the clamp nut with the wrench provided.

POSITIONING THE GUARD

⚠ WARNING

Guard must be positioned correctly to protect the operator. Rotate the guard to the correct position as noted in Fig. 6 or 7. Guard placement depends upon where your hand is positioned on the handle.

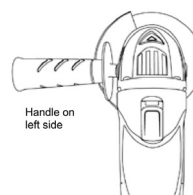

Handle on left side

FIG. 6

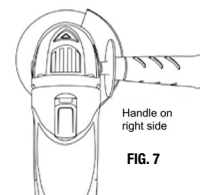

Handle on right side

FIG. 7



4-1/2" ANGLE GRINDER

⚠ WARNING

Never attach a wood cutting or carving blade of any type to this Angle Grinder. It is designed for grinding metal only. Use for any other purpose is not recommended and creates a hazard which will result in serious injury.

⚠ WARNING

Never cover air vents. They must always be open for proper motor cooling.

ON/OFF SWITCH

To turn the switch ON, press the back of the switch slider (3) into the body of the tool. While pressing on the rear of the slider, push it forward (1) until the front part of the switch (2) engages the catch (Fig. 8). When the switch “snaps” into position, the switch will remain ON and the motor will continue running. To turn the switch OFF, press the rear of the slider into the Angle Grinder body. The switch will “snap” to the OFF position.

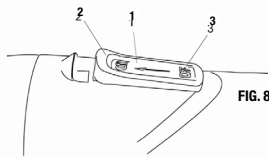

FIG. 8

GRINDING

Always select and use grinding discs that are recommended for the material to be ground. Make sure that the minimum operating speed of the grinding disc selected is not less than 11,000 RPM.

Secure all work before beginning the grinding operation.
Secure small workpieces in a vice or clamp to a workbench.

⚠ WARNING

Never use your grinder with the guard removed. It has been designed for use only with the guard installed. Attempting to use the grinder with the guard removed will result in loose particles being thrown against the operator resulting in serious personal injury.

⚠ WARNING

Never use your grinder without eye protection. Following this rule will reduce the risk of serious personal injury.

The efficient operation of the angle grinder begins by controlling the pressure and surface contact between the grinding disc and the workpiece. Flat surfaces are ground at an acute angle, normally between 5 and 15 degrees (Fig. 9).

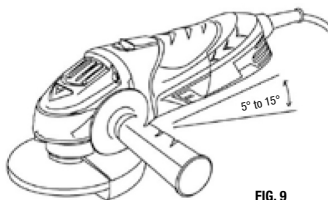

FIG. 9

For maximum control, hold the grinder in front and away from you with both hands, keeping the grinding disc clear of the workpiece. Start your grinder and let the motor and grinding disc build up to full speed. Gradually lower the grinder until the grinding disc contacts the workpiece.

For best results, keep the grinder tilted at an angle of between 5 and 15 degrees and continuously moving at a steady, consistent pace. Move the grinder back and forth or up and down over the work area. Keep the grinder moving so that an excessive amount of material is not removed from one area. If the grinder is held in one spot too long, it will gouge and cut grooves in the workpiece. If the grinder is held at too sharp an angle, it will gouge the workpiece because of the concentration of pressure on a small area.

Use just enough pressure to keep the grinder from chattering or bouncing. Heavy pressure will decrease its speed and put a strain on the motor. Normally, the weight of the tool alone is adequate for most grinding jobs. Use light pressure when grinding jagged edges or loose bolts where there is potential for the grinder to snag on the metal edge. Lift the grinder away from the workpiece before turning it OFF.

MAINTENANCE

⚠ WARNING

When servicing, use only identical replacement parts. Use of any other part may create a hazard or cause product damage.

DO NOT abuse power tools. Abusive practices can damage the tool as well as the workpiece.

⚠ WARNING

DO NOT attempt to modify tools or create accessories. Any such alteration or modification is misuse and could result in a hazardous condition leading to possible serious injury. It will also void the warranty.

CLEANING

DO NOT use solvents when cleaning plastic parts. Most plastics are susceptible to damage from various types of commercial solvents and may be damaged by their use. Use a clean cloth to remove dirt, dust, oil, grease, etc.

⚠ WARNING

DO NOT at any time allow brake fluids, gasoline, petroleum-based products, penetrating oils, etc. to come in contact with plastic parts. They contain chemicals that can damage, weaken or destroy plastic.

⚠ WARNING

Always wear safety goggles or safety glasses with side shields during all grinding operations. It is critical that you also wear safety goggles or safety glasses with side shields and a dust mask while blowing dust out of the Angle Grinder with an air jet. Failure to take these safety precautions could result in permanent eye or lung damage.

LUBRICATION

All of the bearings in this Angle Grinder are lubricated with a sufficient amount of high-grade lubricant for the life of the unit under normal conditions. Therefore, no further lubrication is required.

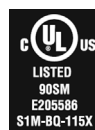

This symbol designates that this tool is listed with U.S. requirements by ETL Testing Laboratories, Inc. Conforms to UL 60745-1, 60745-2-3. Certified to CAN/CSA STD C22.2 No. 60745-1, 60745-2-3.





4-1/2" ANGLE GRINDER

Parts Diagram

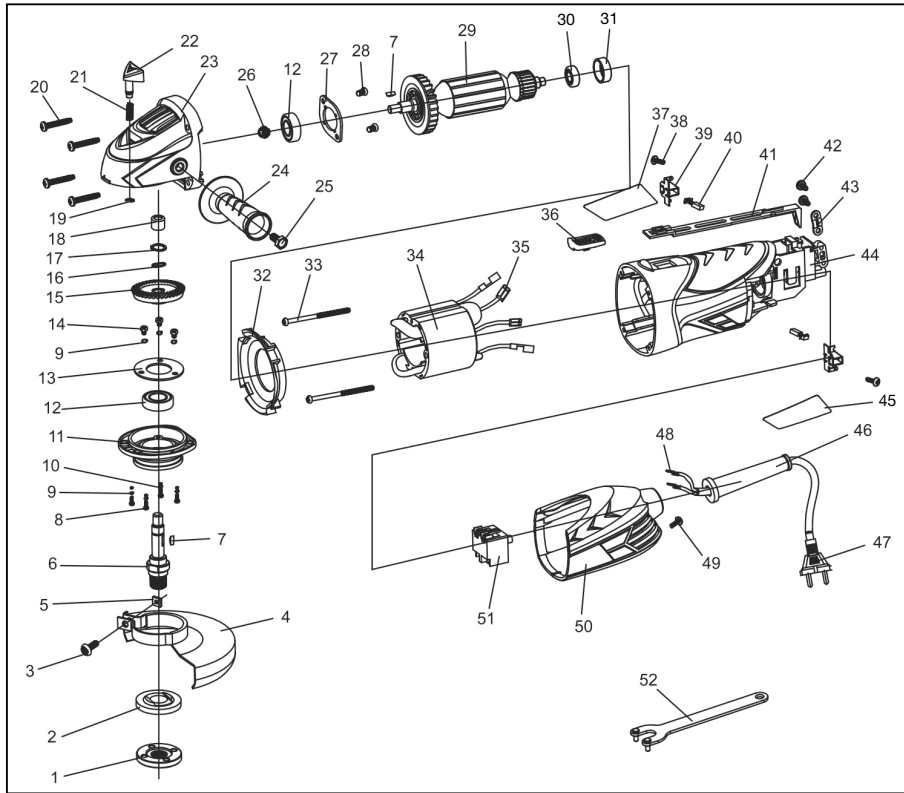

NOTE: Not all components of the Angle Grinder are replacement items, but are illustrated as a convenient reference for location and position in the assembly sequence. OEM® and/or its distributors have provided the parts list and assembly diagram as a reference only. Neither OEM® nor its distributors make any representation or warranty of any kind to the buyer and/or user of this tool that he or she is qualified to do any repairs or replace any parts of this product. OEM® and its distributors expressly state that all repairs or parts replacement should be done by certified or licensed technicians. The buyer assumes all risk and liability arising out of his or her repairs or parts replacement to the original production.

Parts List

Item #	Description	Qty.
1	Outside Flange	1
2	Inner Flange	1
3	Screw M5 x 16	1
4	Wheel Guard	1
5	Nut	1
6	Spindle	1
7	Key	2
8	Screw M4 x 12	4
9	Spring Washer	7
10	Plain Washer	4
11	Gear Box Cover	1
12	Bearing 6000	2
13	Bearing Cover	1
14	Screw M4 x 8	3
15	Gear	1
17	Criclip	1
18	Bush	1
19	Circlip for Spindle Lock Button	1
20	Screw ST4.2 x 20	4
21	Spring	1
22	Spindle Lock Button	1
23	Gear Box	1
24	Side Handle	1
25	Screw M8 x 16	1
26	Pinion	1
27	Bearing Cover	1

Item #	Description	Qty.
28	Screw M4 x 8	2
29	Rotor	1
30	Bearing 607	1
31	Rubber Bushing	1
32	Air Deflector	1
33	Screw ST4.2 x 60	2
34	Stator	1
35	Connection Piece	6
36	Switch Trigger	1
37	Label	1
38	Screw ST2.9 x 8	2
39	Carbon Brush Holder	2
40	Carbon Brush	2
41	Switch Slide	1
42	Screw ST4.2 x 8	2
43	Cord Clip	1
44	Housing	1
45	Name Plate	1
46	Cord Sleeve	1
47	Cord and Plug	1
48	Connection Piece	2
49	Screw ST4.2 x 12	1
50	Housing Cover	1
51	Switch	1
52	Spanner	1



4-1/2" ANGLE GRINDER

OEMTOOLS™ ONE YEAR WARRANTY

For up to one year from the date of purchase of this OEMTOOLS™ product you find any defect in material or workmanship, through normal usage, return it to the place of purchase or to OEMTOOLS™ for repair or replacement at our discretion. In order to obtain this service, send your tool and proof of purchase, transportation pre-paid, to OEMTOOLS™ Q.A. Dept., 3580 E. Raines Road #3, Memphis, TN 38118. We will not be responsible for lost or damaged goods during transportation; please insure your package. If our inspection verifies the defect, we will either repair or replace the product at our election, or we may elect to refund the purchase price if we cannot readily and quickly provide you with a replacement. We will return repaired products at our expense, but if we determine there is no defect, or that the defect resulted from causes not within the scope of our warranty, then you must bear the cost of returning the product.

OEMTOOLS™ does not provide warranty for products labeled other than OEM® or OEMTOOLS™. OEMTOOLS™ will not provide any warranty for products subjected to abnormal use. Abnormal use includes, but is not limited to, abuse, accident, alteration, neglect, and unauthorized or unreasonable use or repairs. This warranty does not cover bits, blades, files, batteries, or calibration. We recommend that you maintain your tools and sharpen or replace blades, bits, files, and batteries as necessary. OEMTOOLS™ reserves the right to make any changes in construction or design at any time without any obligation in incorporating such changes to tools or equipment previously sold.

OEMTOOLS™ makes every effort to ensure that its products meet high quality and durability standards, and warrants to the original purchaser that this product is free from defects in materials and workmanship for the period of one year from the date of purchase. This warranty does not apply to damage due directly or indirectly to misuse, abuse, negligence or accidents, repairs or alterations outside our facilities, criminal activity, improper installation, normal wear and tear or to lack of maintenance.

We shall in no event be liable for death, injuries to persons or property, or for incidental, contingent, special or consequential damages arising from the use of our product. Some states do not allow the exclusion or limitation of incidental or consequential damages, so the above limitation of exclusion may not apply to you. THIS WARRANTY IS EXPRESSLY IN LIEU OF ALL OTHER WARRANTIES, EXPRESS OR IMPLIED, INCLUDING THE WARRANTIES OF MERCHANTABILITY AND FITNESS. This warranty gives you specific legal rights, and you may also have other rights, which vary from state to state.

CONTACT US

3580 E. Raines Road, Suite 3, Memphis, TN 38118
Tel: 1-866-458-2472
www.oem-tools.com