

2006- MAZDA MX-5 MIATA 2.0L 4CYL.

FIGURE 1

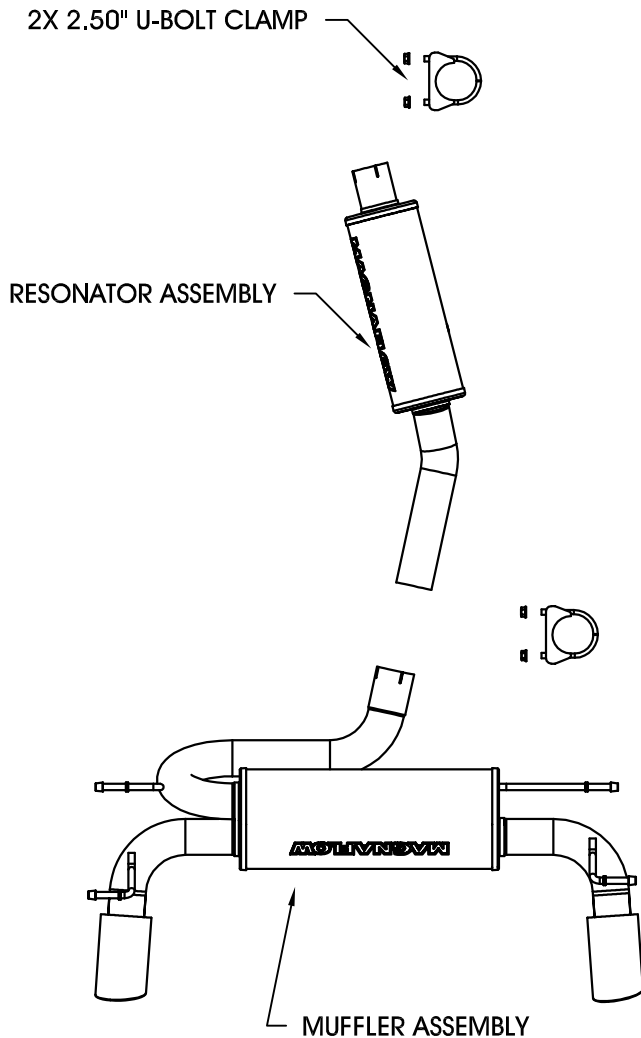

Warning: When working on, under, or around any vehicle exercise caution. Please allow the vehicle's exhaust system to cool before removal, as exhaust system temperatures may cause severe burns. If working without a lift, always consult vehicle manual for correct lifting specifications. Always wear safety glasses and ensure a safe work area. Serious injury or death could occur if safety measures are not followed.

Step 1: (Carefully read all instructions before installation) Disconnect the vehicle's battery before removal of the OEM exhaust. This will allow the computer to reset itself with the new system, and prevent electrical accidents. Removing the OEM system requires cutting the pipe in front of the resonator and behind the welded hanger bracket, as seen in figure 2. Cut the pipe 6" behind the bracket. Unbolt the flange at the muffler and remove the OEM resonator. Disengage the welded hangers from the rubber insulators and remove the muffler. Do not discard the OEM fasteners or damage the OEM rubber insulators, as they will be reused to mount the new system. Be sure to deburr the cut pipe before installation of the new system.

Step 2: Begin installing the new system by inserting the resonator assembly over the OEM pipe where it was cut in step 1. Secure it in place using a supplied 2.5" U-bolt clamp. Leave all clamps and fasteners loose for final adjustment of the complete system. Install the muffler assembly by connecting the inlet pipe to the resonator assembly using the other supplied 2.5" clamp, and by engaging the welded hangers into the rubber insulators.

Step 3: With all components mounted loosely, adjust the system for overall aesthetics and clearance of frame & bodywork. (MAGNAFLOW recommends at least 1/2" of clearance between the exhaust system and any body panels to prevent heat-related body damage or fire.)

*MAGNAFLOW Performance Exhaust recommends professional installation on all their products

Technical support: 1-800-959-9226 ext. 4500

2006- MAZDA MX-5 MIATA 2.0L 4CYL.

FIGURE 2



*Cut OEM pipe 6" behind the white line, drawn at the welded hanger bracket.

Warning: When working on, under, or around any vehicle exercise caution. Please allow the vehicle's exhaust system to cool before removal, as exhaust system temperatures may cause severe burns. If working without a lift, always consult vehicle manual for correct lifting specifications. Always wear safety glasses and ensure a safe work area. Serious injury or death could occur if safety measures are not followed.

Step 4: Once a final position has been chosen for the new system, evenly tighten all fasteners from front to rear. The supplied band clamps must be VERY tight to properly align the pipes and prevent leaks (Approximately 65ft-lbs). U-bolt clamps should be tightened to approximately 30-35ft-lbs. Inspect all fasteners after 25-50 miles of operation and retighten if necessary.