



Equipped with AEM® Dryflow™ Filter
No Oil Required!

INSTALLATION INSTRUCTIONS

PART NUMBER: 21-8222

2009-2011 DODGE RAM 1500 V8-5.7L

SEE * NOTE

* **NOTE:** Legal in California only for racing vehicles which may never be used upon a highway

PARTS LIST

	Description	Qty.	Part Number
A	1/2" Bnd. Hose Clamp, 2.90"-3.75"	1	9452
B	Elbow, Adapter Ram	1	5-593
C	1/2" Bnd. Hose Clamp, 3.56"-4.50"	2	9464
D	Inlet Pipe	1	2-82221
E	Grommet, 1/2"	1	784634
F	Hose Clamp, 1 1/4" Narrow	2	4093-8
G	Hose; 3/4"ID X 29"L	1	5-4029
H	Mount, Rubber 1" X 8mm	1	1228560
I	Washer, 8mm Soft Mount	14	559960
J	Nut, M8 Hex Serrated	8	444.460.08
K	Heat Shield; A	1	20-8507
L	Heat Shield; C	1	20-8509
M	Heat Shield; B	1	20-8508
N	Bolt; M6 X 1.00" 12mm Button Head, SS	12	07794
O	Washer; 1/4" Lock, ZN	12	08198
P	Washer; 6mm Flat, SS	12	08269
Q	Bracket; Heat Shield Front TB/PC	1	32-3065
R	Bolt, Hex/Flange M8-1.25 X 20	6	1-2025
S	Bracket, Heat Shield Ram Btm, TB/PC	1	32-3062
T	Bracket, Heat Shield Ram Top, TB/PC	1	32-3063
U	Edge Trim, 12"	1	8-4012
V	Edge Trim, 17"	1	8-4017
W	Edge Trim, 30"	1	8-4030
X	Insert, Diesel A/F Assy. 4"	1	5-2259
Y	Element Parts Kit 4.00x 9" DSL Oval Dry	1	21-2259DK
Z	Cable, IAT Extension	1	8-322

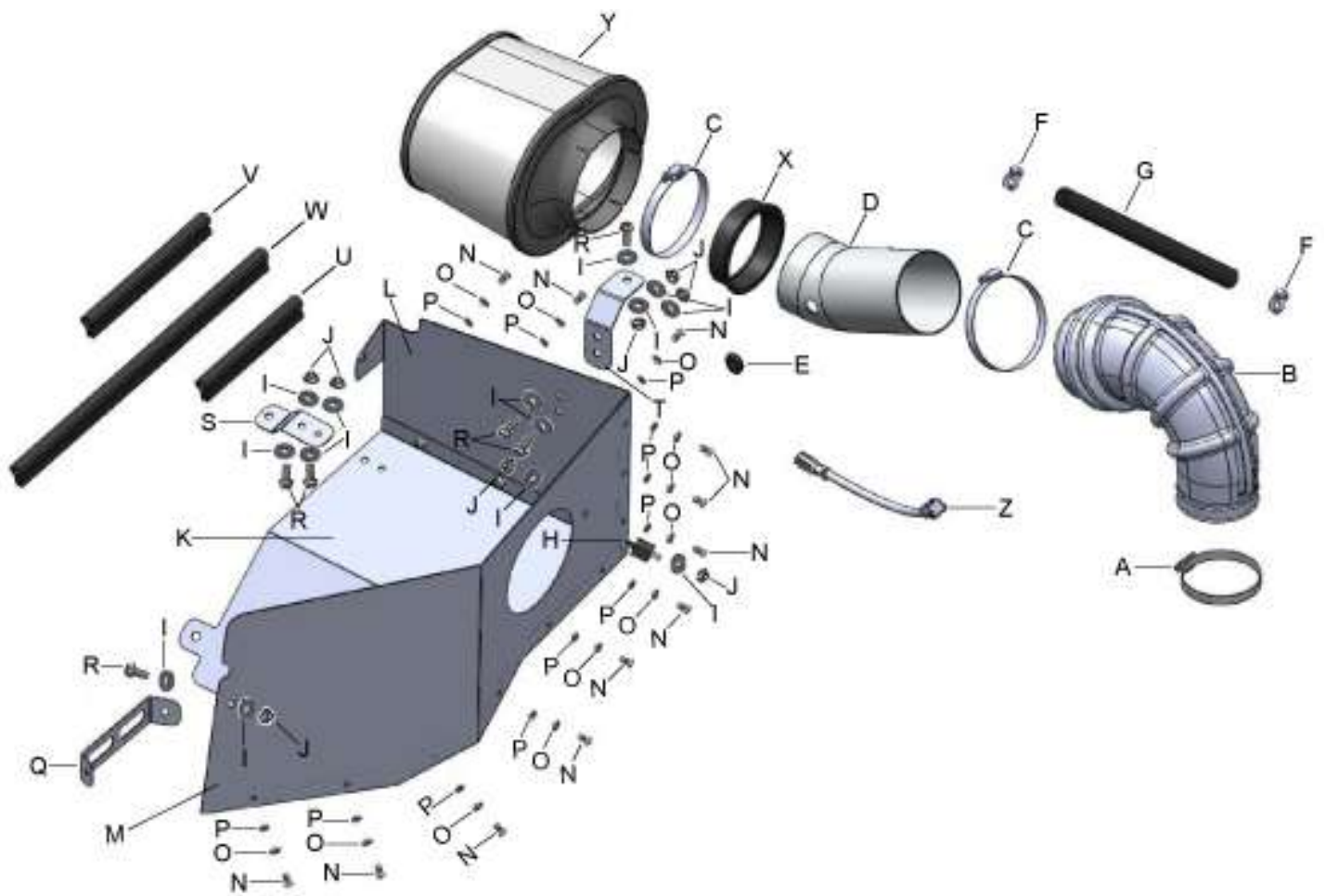

Read and understand these instructions **BEFORE** attempting to install this product. Failure to follow installation instructions and not using the provided hardware may damage the intake tube, throttle body and engine.

1. Preparing Vehicle

- a. Make sure vehicle is parked on level surface.
- b. Set parking brake.
- c. If engine has run in the past two hours, let it cool down.
- d. Disconnect negative battery terminal.
- e. Do not discard stock components after removal of the factory system.

2. Removal of stock system



a. Remove all fasteners securing the passenger side fender liner. **WARNING:** After dropping the liner, be sure to unclip the ABS sensor wiring harness attached to the engine side of the liner.



b. Remove the fender liner from the vehicle.



c. With the fender liner removed, access the air box from the bottom of the fender well and remove the 2 bolts securing the air box to the vehicle. Keep the bolts for use in a later step.



d. Unlock the Intake Air Temperature (IAT) sensor connector by sliding the red tab and pressing the clip to disconnect the wiring harness from the sensor.

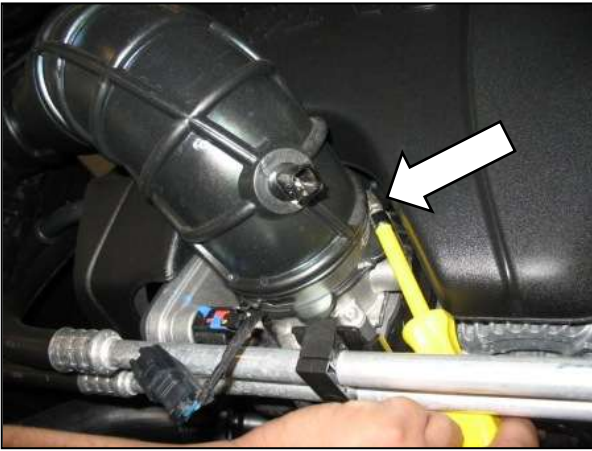

e. Loosen hose clamp securing the factory inlet duct to the throttle body.



f. Disconnect engine breather hose at the air box lid.



g. Unclip the air box lid from the air box base.



h. Remove the air box lid and inlet duct.

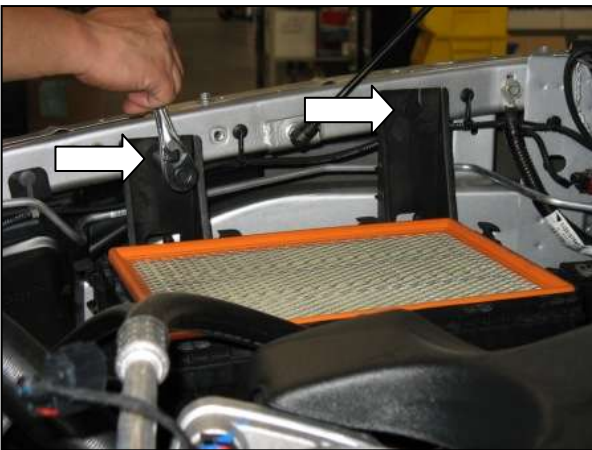

i. Remove the 2 bolts securing the air box base to the vehicle.



j. Remove the air box base and air filter from the vehicle.



k. Remove the engine cover by lifting the front of the cover and then pulling forward.



l. Remove the breather tube and hose from the engine.

3. 3-Piece Heat Shield Assembly



a. Attach the rear heat shield panel "C" to the bottom heat shield panel "A" using 3 each of the M6 x 12MM button head bolts, 6MM lock washers, and 6MM flat washers. Leave the bolts loose for now.



b. Here is another view of rear panel "C" attached loosely to bottom panel "A".

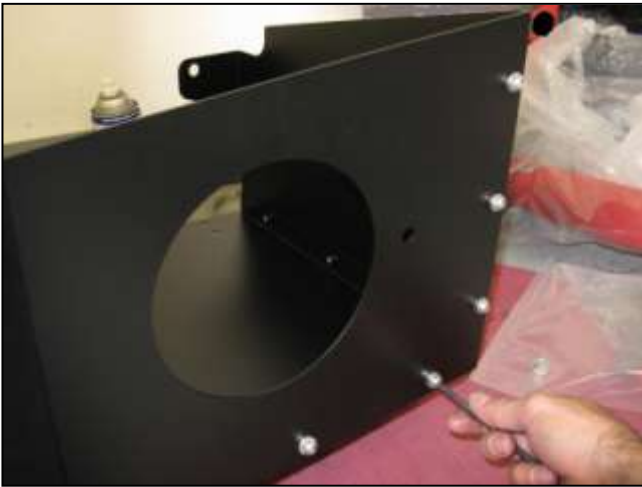

c. Now attach side Panel "B" to both panels "A" and "C" with 9 more M6 button head bolts, lock washers, and flat washers. Install the bolts loosely at first, then tighten them once the panels are in the correct position.



d. Here is the complete heat shield assembly. You may install the sponge rubber gaskets in the large hole (medium length gasket) and along the top edges (short and long gaskets) as shown at this time. Trim any excess as needed.

4. Installation of AEM® intake system.

a. When installing the intake system, do not completely tighten the hose clamps or mounting hardware until instructed to do so.



b. Install the 3/4" ID hose and 1 1/4" hose clamp as shown.



c. With the hose fully engaged on the nipple, fully tighten the hose clamp.



d. Install the bottom heat shield bracket under the passenger side fender rail using the factory bolt removed from Step 2c.



e. Carefully position the heat shield into the vehicle. Use the bolt removed in Step 2i to hold the heat shield in place. Tighten the bolt about $\frac{3}{4}$ of the way into the thread for now.



f. On the bottom side of the heat shield, secure the tab coming off the heat shield to the vehicle using the bolt removed in Step 2c. Tighten the bolt about $\frac{3}{4}$ of the way into the thread for now.

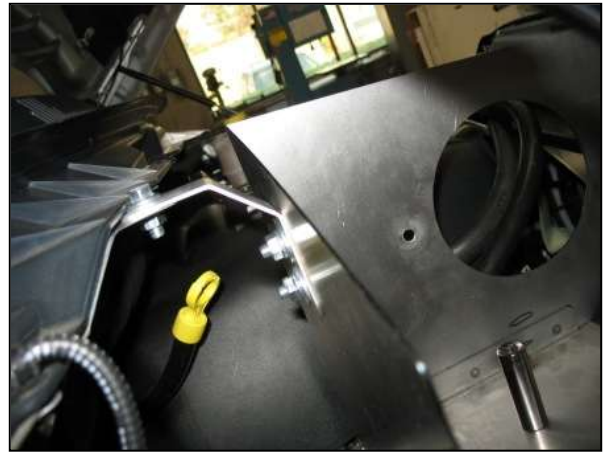

g. Install the rear bracket onto the top lip of the fire wall as shown. Use (Qty. 3) M8 x20mm bolts, (Qty. 3) nuts and (Qty. 6) washers to secure the bracket.



h. Here is another view of the rear bracket installation.



i. On the passenger side of the radiator support, remove the long bolt as shown.



j. Install the front bracket to the heat shield using an M8 x 20MM bolt, a nut, and 2 washers. The bracket has 2 bent tabs at its ends. Make sure the longer tab mates to the heat shield.



i. The front bracket should look as shown when installed.



n. Install 2 M8 washers and 2 M8 nuts to secure the bolts positioned in the previous step. Now go back and tighten all the heat shield bracket nuts and bolts installed.



k. Secure the front tab of the bracket to the vehicle using the long bolt removed in step 3i.



m. At the bottom bracket, hold 2 M8 bolts and 2 washers in position, aligning the bracket to the heat shield.



o. Install the rubber isolator mount on the outside of the heat shield assembly as shown.



p. Use 1 M8 washer and 1 M8 nut inside the heat shield to secure the rubber mount.

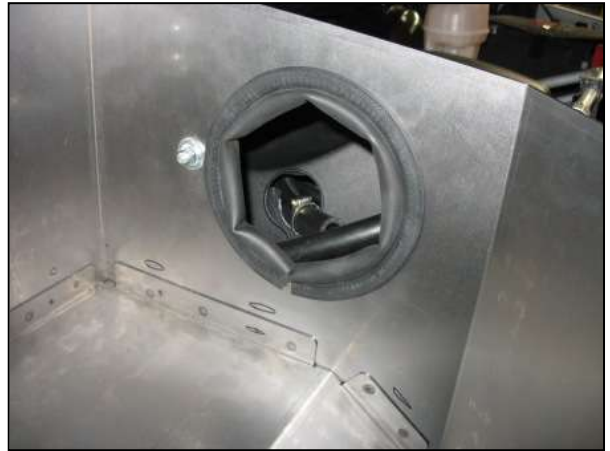

q. Install the medium section of the rubber sponge edge gasket in the large hole for the inlet tube as shown.



r. Install the short and the long sections of the rubber sponge edge gasket along the top edge of the heat shield as shown.



s. Re-install the factory engine cover, allowing the new breather hose to protrude from the access hole as shown. Place the second 1 1/4" hose clamp loosely on the end of the hose.



t. Carefully remove the inlet air temperature (IAT) sensor from the OEM inlet duct.



u. Carefully install the IAT sensor into the new inlet pipe using the supplied rubber grommet. If necessary, use soapy water to ease the installation of the grommet; then install the IAT sensor into the grommet.



v. Loosely install hose clamps onto the intake adapter elbow as shown. Use clamp size 9464 on the larger end and clamp size 9452 on the smaller end.



w. Install the inlet pipe into the adapter elbow, use soapy water to ease installation if necessary. Install the adapter insert into the open end of the inlet pipe.



x. Install the intake pipe assembly, inserting the open end through the large hole in the heat shield while also mounting the elbow inlet onto the throttle body neck.



y. Tighten the smaller hose clamp of the elbow inlet at the throttle body.



z. Connect the IAT sensor cable extension to the original wiring harness and lock the red tabs on the female connectors. Connect the opposite end of the IAT sensor cable extension to the IAT sensor.



aa. Connect the breather hose to the nipple on the other side of the inlet tube and tighten the 1-1/4" hose clamp.

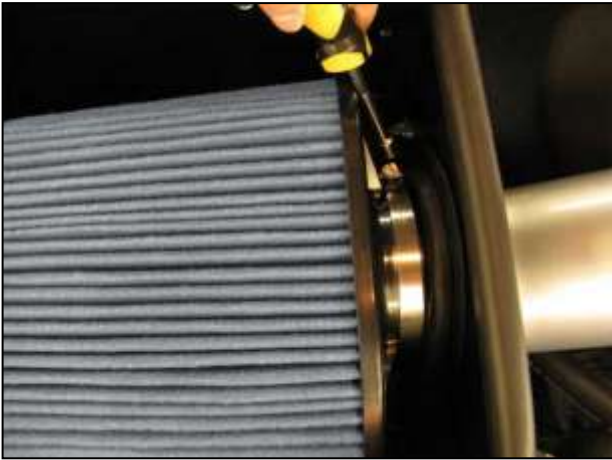

ab. Place the large hose clamp over the air filter's inlet. Place the air filter inside the heat shield, then fully seat the filter onto the filter adapter. Insert the open end of the inlet pipe and loosely secure the hose clamp to hold the air filter in place.



ac. Shift the inlet pipe until the slot in the mounting bracket lines up with the isolator bolt mounted on the heat shield. Place one 8MM flat washer and one M8 nut on the bolt and fully tighten. Now go back and fully tighten the larger air filter and inlet pipe hose clamps.



Factory air box system installed



AEM® intake system installed

4. Reassemble Vehicle

- a. **Fender liner:** Install the fender liner and any hardware that was removed in steps 2a through 2b. Make sure the ABS wiring harness is reattached to the engine-side surface of the fender liner.

NOTE: Failure to install the fender liner will result in diminished performance and increase the potential for engine damage due to water ingestion in rainy conditions.

- b. Position the inlet pipes for the best fitment. Be sure that the pipes or any other components do not contact any part of the vehicle. Tighten the rubber mount, all bolts, and hose clamps.
- c. Check for proper hood clearance. Re-adjust pipes if necessary and re-tighten them.
- d. Inspect the engine bay for any loose tools and check that all fasteners that were moved or removed are properly tightened.
- e. Reconnect negative battery terminals and start engine. Let the vehicle idle for 3 minutes. Perform a final inspection before driving the vehicle.

5. Service and Maintenance

- a. It is recommended that you service your AEM[®] Dryflow™ filter every 20,000 miles for optimum performance. Use AEM Dryflow cleaning kit part # 21-110.
- b. Use aluminum polish to clean your polished AEM[®] intake tube.
- c. Use window cleaner to clean your powder coated AEM[®] intake tube. **(NOTE: DO NOT USE aluminum polish on powder coated AEM intake tubes)**

For technical inquiries
e-mail us at
sales@aemintakes.com
or
call us at
800.992.3000

AEM Air Intake System Warranty Policy

AEM[®] warrants that its intake systems will last for the life of your vehicle. AEM will not honor this warranty due to mechanical damage (i.e. improper installation or fitment), damage from misuse, accidents or flying debris. AEM will not warrant its powder coating if the finish has been cleaned with a hydrocarbon-based solvent. The powder coating should only be cleaned with a mild soap and water solution. Proof of purchase of both the vehicle and AEM intake system is required for redemption of a warranty claim.

This warranty is limited to the repair or replacement of the AEM part. In no event shall this warranty exceed the original purchase price of the AEM part nor shall AEM be responsible for special, incidental or consequential damages or cost incurred due to the failure of this product. Warranty claims to AEM must be transportation prepaid and accompanied with dated proof of purchase. This warranty applies only to the original purchaser of product and is nontransferable. Improper use or installation, use for racing, accident, abuse, unauthorized repairs or alterations voids this warranty. AEM disclaims any liability for consequential damages due to breach of any written or implied warranty on all products manufactured by AEM. Warranty returns will only be accepted by AEM when accompanied by a valid Return Merchandise Authorization (RMA) number. Credit for defective products will be issued pending inspection. Product must be received by AEM within 30 days of the date RMA is issued.

If you have a warranty issue, please call (800) 992-3000 and our customer service department will assist you. A proof of purchase is required for all AEM warranty claims.