



# INSTALLATION AND OPERATION MANUAL



[fullriverbattery.com](http://fullriverbattery.com)

# CONGRATULATIONS ON YOUR PURCHASE OF A FULLRIVER BATTERY!

Maximize the performance of your new battery  
by thoroughly reading this manual.

## FULLRIVER BATTERY

3823 MISSION OAKS BLVD, STE A  
CAMARILLO, CA 93012

TOLL FREE: (800) 522-8191  
INT'L: (805) 484-7900

[WWW.FULLRIVERBATTERY.COM](http://WWW.FULLRIVERBATTERY.COM)

*This publication is protected by copyright. All rights are reserved. At no point, may any part of this publication be copied, reproduced, or transmitted by any means or any format without prior written consent from Fullriver Battery.*

*Fullriver Battery is not liable for direct, indirect, special, exemplary, incidental or consequential damages that may result from any information provided in or omitted from this manual, under any circumstances.*

*Fullriver Battery reserves the right to make adjustments to this manual at any time, without prior notice or obligation.*

*Fullriver Battery and the Fullriver Battery logo are registered trademarks of Fullriver Battery Mfg. Co. Ltd.*



<b>1.</b>	<b>GETTING STARTED</b> .....	<b>2</b>
	1.1 - Safety	
	1.2 - Equipment checklist	
<b>2.</b>	<b>INSTALLATION</b> .....	<b>3-7</b>
	2.1 - Selecting the appropriate cable size	
	2.2 - Terminal connections	
	2.3 - Battery orientation	
	2.4 - Series connections	
	2.5 - Parallel connections	
	2.6 - Series / parallel connections	
	2.7 - Cross tying batteries in parallel packs	
	2.8 - Charging batteries before use	
<b>3.</b>	<b>OPERATION</b> .....	<b>8-9</b>
	3.1 - Temperature effects on battery performance and life	
	3.2 - Operating temperature range	
	3.3 - Low discharge rate effects	
	3.4 - Depth of Discharge (D.O.D.) vs. Battery Life	
<b>4.</b>	<b>CHARGING</b> .....	<b>10-11</b>
	4.1 - Charger inspection	
	4.2 - Charging your Fullriver batteries	
	4.3 - Charging temperature range	
	4.4 - Charging parameters	
	4.4.1 - Current	
	4.4.2 - Voltage settings	
	4.4.3 - Temperature compensation	
<b>5.</b>	<b>STORAGE</b> .....	<b>12-13</b>
	5.1 - Battery storage procedure	
	5.2 - Temperature effects on self-discharge	
	5.3 - Storage temperature range	
<b>6.</b>	<b>TESTING</b> .....	<b>14-16</b>
	6.1 - Test preparation	
	6.2 - Open circuit voltage test	
	6.3 - Discharge test	
	6.4 - Optional test	
	6.5 - CCA test	
	6.6 - Battery replacement instructions	
<b>7.</b>	<b>YOUR CLEAN-GREEN ENERGY SOLUTION</b> .....	<b>16-17</b>
	7.1 - Fullriver products	
	7.2 - Fullriver manufacturing	
	7.3 - Solar setting recommendations	
<b>8.</b>	<b>TRANSPORTATION INFORMATION</b> .....	<b>18</b>
<b>A.</b>	<b>APPENDIX</b> .....	<b>19</b>
	A.1 - Temperature ranges	
	A.2 - State of Charge (S.O.C.) vs. Open Circuit Voltage (O.C.V.)	
	A.3 - Bolt / Nut Specifications	





# **INSTALLATION AND OPERATION MANUAL**



# Getting Started

Before installing your Fullriver battery, please adhere to the following safety guidelines and make sure that you have the proper equipment for installation, operation, and diagnostic testing.

## 1.1 - SAFETY

### PROTECT YOURSELF AND PROTECT YOUR BATTERY

- Wear protective gear, including gloves, when handling a battery.
- Install and remove a battery using the lifting handles provided.
- Use a wrench with a rubber coated handle for installing, tightening, or removing battery connections.
- Do not place any objects on top of a battery.
- Do not smoke near a battery.
- Keep flames, sparks and metal objects away from a battery.
- Charge batteries in a ventilated area - although AGM and Gel batteries typically do not release gas. The safety valve may open to alleviate excess pressure if the battery is over-charged.

### ALWAYS USE CAUTION AROUND A BATTERY

## 1.2 - EQUIPMENT CHECKLIST

- Gloves
- Wrench with insulated / rubber coated handle
- Voltmeter
- Charger
- Discharger (if available)

Proper battery installation is the first step in getting the best performance out of your Fullriver battery.

## 2.1 - SELECTING THE APPROPRIATE CABLE SIZE

Cables must be sized to carry the maximum expected load. Under-sized cables can result in over-heating, melted connections and are a potential fire hazard.

Refer to **TABLE 1** below for the current carrying capacity by cable size. These values are for cable lengths of 6 feet (1.83 meters) or less. It is preferable that all cables in a series connection or in a parallel connection are the same length.

Cable Gauge (AWG)	Ampacity (Amps)
14	25
12	30
10	40
8	55
6	75
4	95
2	130
1	150
1/0	170
2/0	265
3/0	360

TABLE 1



To significantly reduce the amount of heat generated at the terminals, use cables with solder-dipped ends.

# Installation

## 2.2 - TERMINAL CONNECTIONS

Terminal connections must be tightened using the correct torque values as defined in **TABLE 2** below. Over or under tightened connections can result in terminal breakage, over-heating and/or meltdown. Using the proper torque value will provide optimum conductivity. To avoid a short circuit, use a wrench with an insulated or rubber coated handle when making terminal connections. See **DIAGRAM 1** below for proper washer placement.

TERMINAL TORQUE SPECS							
Terminal Type	ft-lbs	lbs-in	Nm	Terminal Type	ft-lbs	lbs-in	Nm
M6, AP	4.1-5.8	50-70	5.6-7.9	M10M (Stud)	7.7-9.6	92-115	10.4-13
M8	7.1-7.9	85-95	9.6-10.7	3/8" Stud	8.9-12	106-150	12-16.9
M10	9.6-12	115-141	13-16	FR45	5.8-7.4	70-90	7.9-10.1
M6M (Stud)	3.3-4.6	40-56	4.5-6.3	TP06 (AP)	3.3-4.6	40-56	4.5-6.3
M8M (Stud)	4.9-6.3	58-75	6.6-8.5	TP08/TP68 (AP)	5.2-6.9	63-83	7.1-9.4



**NEVER** place a washer between the mating surfaces of the terminals and cables. This will compromise electrical transmission and increase resistance, resulting in extreme heat generation and probable terminal melting.

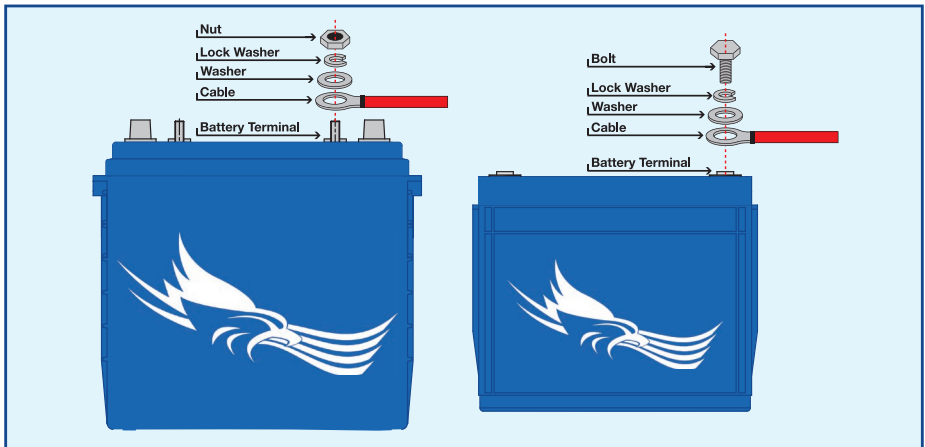

DIAGRAM 1



Loctite® Threadlocker may be used to better secure the terminal connections. Be careful not to get Loctite® between the mating surfaces of the terminal.



## 2.3 - BATTERY ORIENTATION

The ideal placement of batteries is upright. AGM and Gel batteries can be placed on their side if necessary. It is preferred that all the batteries within a pack be placed in the same orientation.



**NEVER** place batteries in an inverted orientation (terminals pointed towards ground).

## 2.4 - SERIES CONNECTIONS

There is more than one option to meet your voltage requirements. For example, for a 12 volt system, you may use one (1) 12 volt battery or two (2) 6 volt batteries wired in a series to make up the 12 volts. You may use as many batteries as you need to make up the system voltage. Connect the positive of one battery to the negative of the next through the entire string. See **DIAGRAM 2** below for the proper series connection.

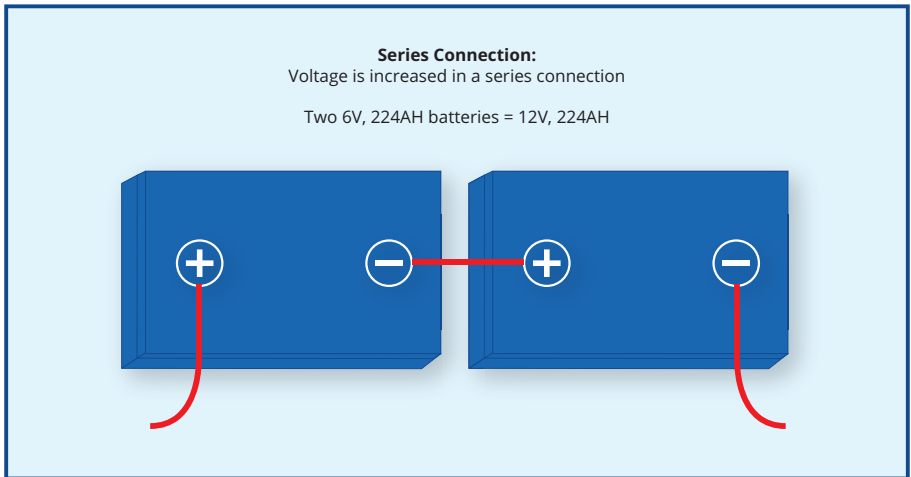

DIAGRAM 2

# Installation

## 2.5 - PARALLEL CONNECTIONS

There is more than one option to meet your energy requirements. For example, to meet the requirements for a 210 Amp-Hour system, you may use one (1) 210 Amp-Hour battery or two (2) 105 Amp-Hour batteries wired in parallel to make up the 210 Amp-Hours. Connect all the positive terminals together and all the negative terminals together in the string. See **DIAGRAM 3** below for proper parallel connection.

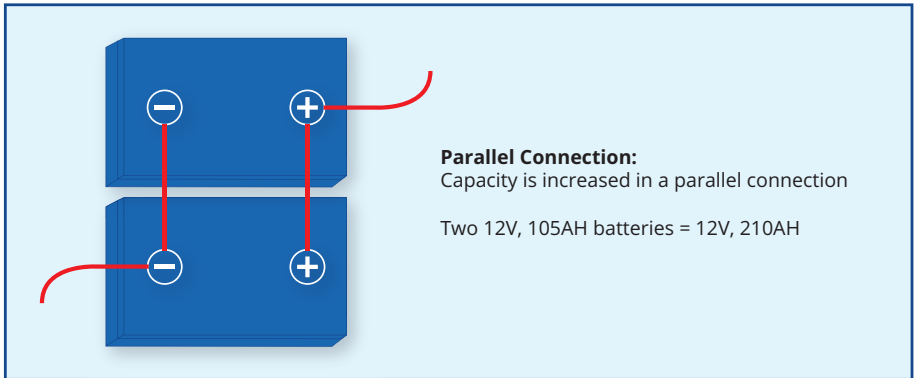

DIAGRAM 3

## 2.6 - SERIES / PARALLEL CONNECTIONS

Batteries can be connected in both series and parallel to attain the desired system voltage and energy requirements. See **DIAGRAM 4** below for proper series / parallel connections.

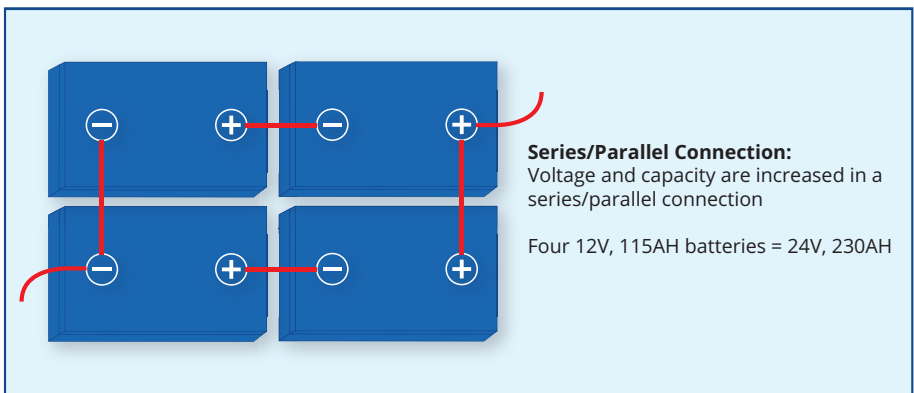

DIAGRAM 4



For optimum performance, the systems positive and negative leads should be connected diagonally opposite (catty-corner) from each other.

## 2.7 - CROSS TYING BATTERIES IN PARALLEL PACKS

In order to maintain balance in parallel battery packs, it is best to cross tie the batteries. This method of connection will maximize the performance and life of your battery system. Cross-tying batteries means connecting positive to positives and negatives to negatives of each adjacent battery in the set. See **DIAGRAM 5** below for proper cross tying connections. The dotted lines represent the cross tied cables.

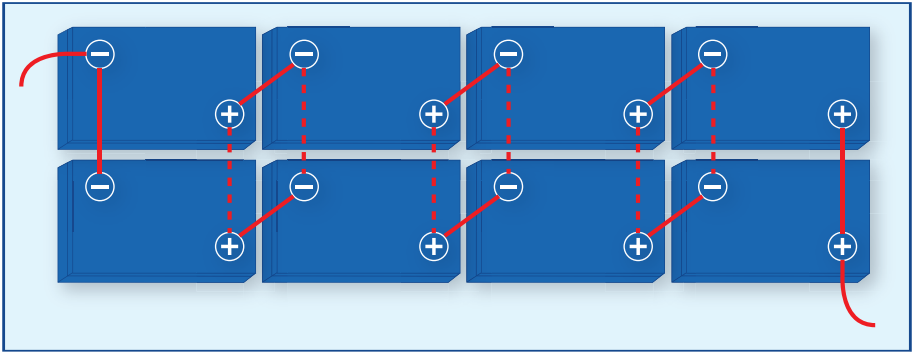

**DIAGRAM 5**



Leave some space between batteries for airflow and minor battery expansion.

## 2.8 - CHARGING BATTERIES BEFORE USE

New AGM or Gel batteries that have only been stored up to six months will not need to be charged prior to being put into service.

If new AGM or Gel batteries have been stored for more than six months, and/or in an exceptionally hot environment, a charge may be necessary prior to being put into service. Also, if the batteries are not charged prior to being put into service, you may experience a slight reduction in range on the first cycle.

Battery Nominal Voltage	Open Circuit Voltage (O.C.V.)
2 Volt	< 2.0 Volts
6 Volt	< 6.2 Volts
8 Volt	< 8.3 Volts
12 Volt	< 12.5 Volts
16 Volt	< 16.7 Volts

**TABLE 3**

Check the open circuit voltage (O.C.V.) of each battery in the set and if any battery within the set is less than the values in **TABLE 3** above, recharge the battery set.

## Operation

The performance and life of a battery will vary with the application, usage, temperature and depth of discharge. AGM and Gel batteries tend to deliver a higher capacity than rated (up to 10-15% higher) until they are broken in (approximately 30 cycles) and settle at their rated capacity.

### 3.1 - TEMPERATURE EFFECTS ON BATTERY PERFORMANCE AND LIFE

Operating batteries above 80°F (27°C) will yield runtimes above the rated capacity while operating batteries below 80°F (27°C) will yield runtimes below the rated capacity. Cold temperatures can significantly reduce battery capacity (as shown in the chart below).

#### TEMPERATURE vs CAPACITY

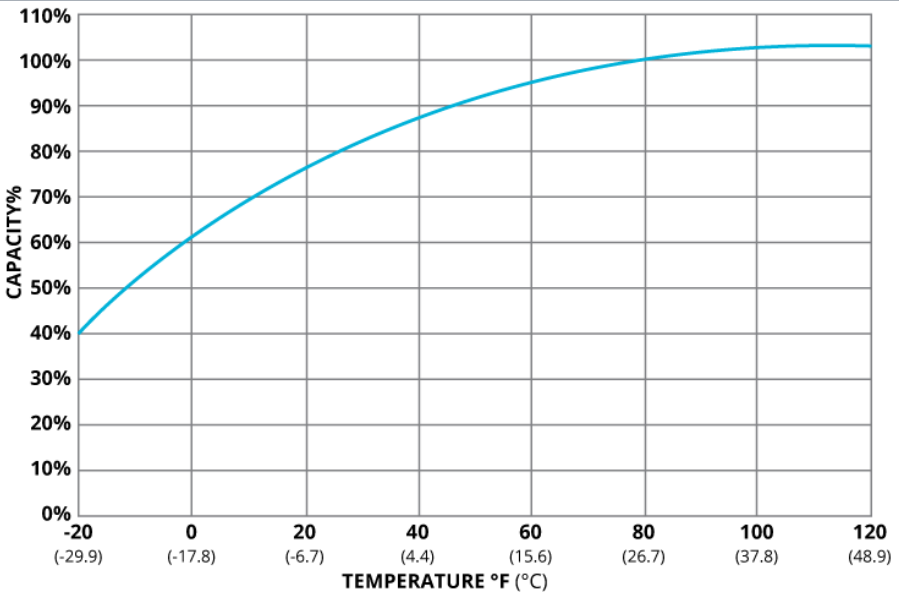

Although higher temperatures increase the battery capacity, they also accelerate corrosion and reduce overall battery life. For example, batteries operating continuously at 100°F (37.8°C), could experience as much as a 25% reduction in life.

### 3.2 - OPERATING TEMPERATURE RANGE

Recommended	Maximum
5°F to 104°F (-15°C to 40°C)	-40°F to 160°F (-40°C to 71°C)

TABLE 4

### 3.3 - LOW DISCHARGE RATE EFFECTS

Battery cycle life will be reduced when the constant load applied in a cyclic application is at or below 0.7% of the total Ah in the battery bank (C20 rating). This is due to a higher rate of sulfation occurring in the middle of the plate that will cause a reduction in available capacity which in turns increases the depth of discharge over time. An effort to either increase the load above 0.7% of C20 and/or reduce the size of the battery bank's capacity so the load is above 0.7% of C20 should be put forth if possible.

### 3.4 - DEPTH OF DISCHARGE VS. BATTERY LIFE

Battery cycle life will vary significantly depending on the depth of discharge. The deeper the depth of discharge, the fewer the cycles a battery will deliver. Conversely, the shallower the depth of discharge, the more cycles a battery will deliver (as shown in the chart below).

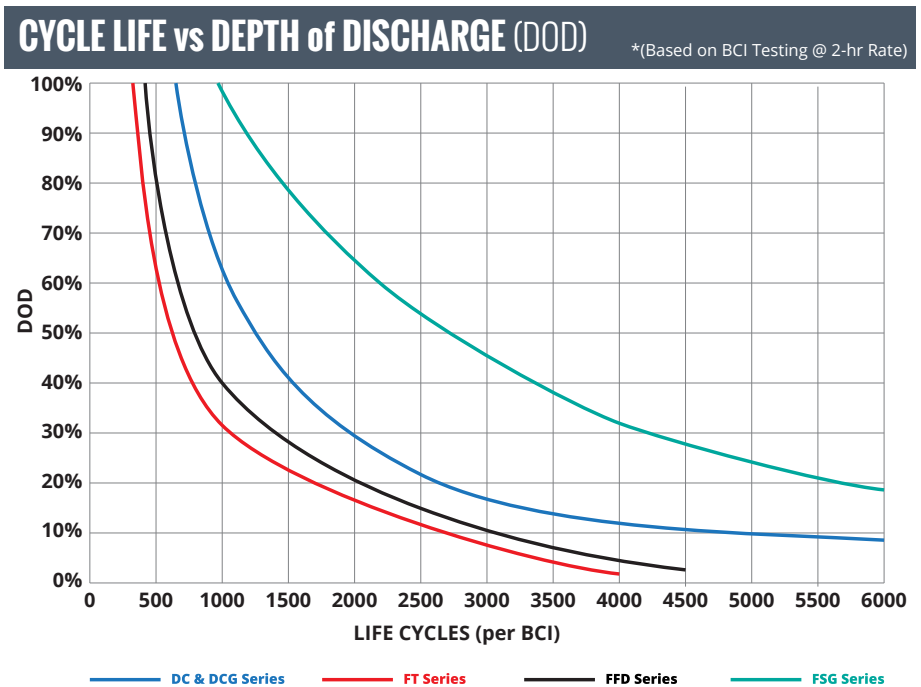

To optimize the health of your battery, limit discharge to 80% or less.

# Charging

Using the proper charger is critical to the performance and life of your AGM or Gel battery. If you are not sure if you have the right charger for AGM or Gel batteries, please call our technical support line at **(800) 522-8191** or email [help@fullriverbattery.com](mailto:help@fullriverbattery.com) for verification.

## 4.1 - CHARGER INSPECTION

1. The charger cable should be insulated and free of breaks or cuts.
2. The cable connectors should be clean and properly mated with the battery terminals to ensure a snug connection.
3. The charger's AC cord should be free of breaks or cuts and the wall plug should be clean.

## 4.2 - CHARGING YOUR BATTERIES

1. Use an AGM charger or setting whenever available for AGM batteries. Use a Gel charger or setting whenever available for Gel batteries.
2. Never use a GEL charger or setting on an AGM battery, as it will undercharge the battery and significantly reduce battery capacity and life.
3. Many, but not all, wet battery chargers will work for an AGM battery. Call technical support at **(800) 522-8191** or email [help@fullriverbattery.com](mailto:help@fullriverbattery.com) to verify your charger. Be prepared to provide the make and model of your charger.
4. Batteries should be fully charged after each use. Opportunity charging can be done, but the batteries should be fully charged at least every other day if they are used daily.
5. Charge in a ventilated area, as gases may be released through the pressure relief valve if the batteries are excessively over-charged.
6. If the charger does not have temperature compensation, avoid charging at temperatures above 122°F (50°C).

## 4.3 - CHARGING TEMPERATURE RANGE

Temp Compensation	Recommended	Maximum
Yes	5°F to 122°F (-15°C to 50°C)	-40°F to 160°F (-40°C to 71°C)
No	32°F to 104°F (0°C to 40°C)	5°F to 122°F (-15°C to 50°C)

TABLE 5

## 4.4 - CHARGING PARAMETERS

Most chargers come pre-set from the factory. If your charger is pre-programmed, use the information below to check if the settings are compatible with AGM or Gel batteries. If you have a programmable charger or inverter, use the following information for settings.

## 4.4.1 - CURRENT

**All Models (excl. FSG):** The recommended bulk current is 20-25% of the 20 Hr AH capacity or  $0.20 \times C20$  (20 Hr. capacity in AH). The maximum allowable bulk current is 35% of the 20 Hr. AH capacity or  $0.35 \times C20$  (20Hr. capacity in AH), unless specified.

**Example:**

*DC115-12 is rated at 115AH @ 20 Hrs.*

*The recommended bulk current is  $0.20 \times 115 = 23$  Amps*

*The maximum bulk current is  $0.35 \times 115 = 40$  Amps*

**FSG Series:** The recommended bulk current is 12.5% of the 10 Hr. AH capacity or  $0.125 \times C10$  (10 Hr. capacity in AH). The maximum allowable bulk current is 15% of the 10 Hr. AH capacity or  $0.15 \times C10$  (10Hr. capacity in AH), unless otherwise stated.

**Example:**

*FSG1660-2 is rated at 1110AH @ 10 Hrs.*

*The recommended bulk current is  $0.125 \times 1110 = 139$  Amps*

*The maximum bulk current is  $0.15 \times 1110 = 167$  Amps*

## 4.4.2 - VOLTAGE SETTINGS (BOLD IS RECOMMENDED SETTING)

Charge State	12 Volt AGM	16 Volt AGM	24 Volt AGM	48 Volt AGM
Bulk	14.4- <b>14.7</b> V	19.2- <b>19.6</b> V	28.8- <b>29.4</b> V	57.6- <b>58.8</b> V
Absorption	14.4- <b>14.7</b> V	19.2- <b>19.6</b> V	28.8- <b>29.4</b> V	57.6- <b>58.8</b> V
Float	13.6- <b>13.7</b> V	<b>18.2</b> V	27.2- <b>27.4</b> V	54.4- <b>54.8</b> V

TABLE 6

Charge State	12 Volt FSG	24 Volt FSG	48 Volt FSG	12 Volt DCG
Bulk	14.4-14.7 V	28.8-29.4 V	57.6-58.8 V	14.1-14.4 V
Absorption	14.4-14.7 V	28.8-29.4 V	57.6-58.8 V	14.1-14.2 V
Float	13.6 V	27.2 V	54.6 V	13.6 V

TABLE 7

## 4.4.3 - TEMPERATURE SETTINGS

If you have a programmable charger or inverter that has a temperature compensation setting, it should be set to  $-4mV / ^\circ C / cell$  or  $-2mV / ^\circ F / cell$ . **TABLE 8** below has the temperature compensation voltage values for a 12V battery. For a 24V, 36V or 48V system, multiply the values in the table by 2, 3 or 4 respectively.

Charge Stage	32°F (0°C)	50°F (10°C)	68°F (20°C)	77°F (25°C)	86°F (30°C)	104°F (40°C)
Bulk	15.30 V	15.06 V	14.82 V	14.70 V	14.58 V	14.34 V
Absorption	15.30 V	15.06 V	14.82 V	14.70 V	14.58 V	14.34 V
Float	14.25 V	14.01 V	13.77 V	13.65 V	13.53 V	13.29 V

TABLE 8

## Storage

AGM and Gel batteries have a much longer shelf life than wet, lead-acid batteries. With a self-discharge of only 1-3% per month, AGM and Gel batteries can be stored for a year or longer without needing to be charged.

### 5.1 - BATTERY STORAGE PROCEDURE

1. Charge batteries before they are placed in storage.
2. Disconnect batteries from the equipment and charger to eliminate any parasitic loads.
3. Check the batteries based on conditions and schedule in **TABLE 9** below.

Temperature	Time
Below 68°F (20°C)	9 months
68°F to 86°F (20°C to 30°C)	6 months
Above 86°F (30°C)	3 months

**TABLE 9**

4. Check the open circuit voltage (OCV) of each battery in the set. If any battery within the set is less than the values in **TABLE 10** below, recharge the battery set.

Battery Nominal Voltage	Open Circuit Voltage (O.C.V.)
2 Volt	< 2.0 Volts
6 Volt	< 6.2 Volts
8 Volt	< 8.3 Volts
12 Volt	< 12.5 Volts
16 Volt	< 16.7 Volts

**TABLE 10**

5. If the charger has a maintenance mode, select that mode to boost charge batteries. Otherwise, run the normal charge cycle.
6. If the batteries are stored shorter than the time periods in **TABLE 9**, they do not need to be recharged prior to being put back into service.



AGM and Gel batteries do not have a memory effect; so there is no need to fully discharge batteries prior to charging.



### 5.2 - TEMPERATURE EFFECTS ON SELF-STORAGE

If the storage environment is hot, batteries will self-discharge faster than in a cold environment as shown in the chart below. The FSG series will discharge approximately 40-60% slower above 86°F than the chart below indicates.

#### SELF DISCHARGE vs TIME/TEMPERATURE

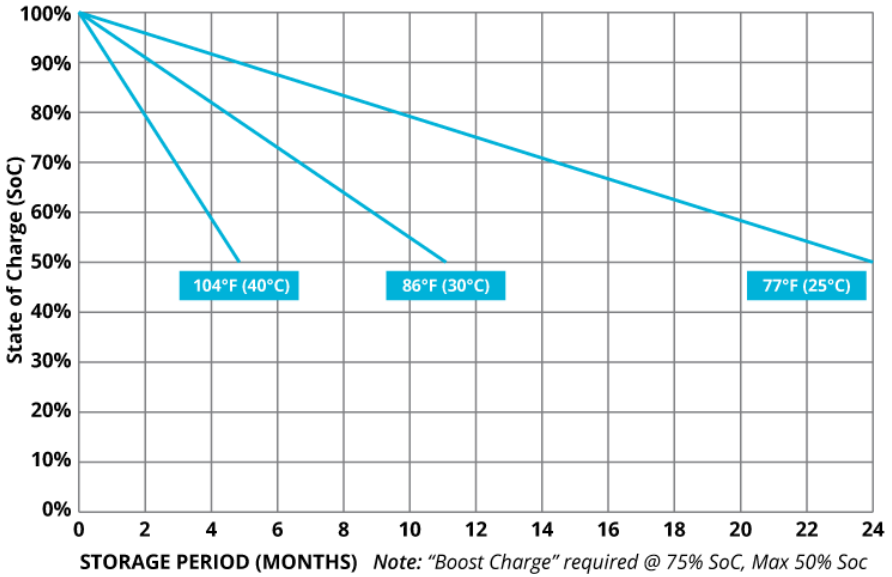

Batteries CAN be safely stored on concrete floors without any negative effects. Concrete floors DO NOT drain batteries.

### 5.3 - STORAGE TEMPERATURE RANGE

Recommended	Maximum
5°F to 122°F (-15°C to 50°C)	-40°F to 160°F (40°C to 71°C)

TABLE 11



Store batteries in a cool, dry environment to minimize self discharge.

# Testing

Testing batteries can be complex and there are many application specific variables that cannot be considered in one simple test. This section is a guide to help you determine the overall condition of your batteries. Contact your local Fullriver Battery distributor for assistance.

## 6.1 - TEST PREPARATION

1. Check that the battery cables are in good working condition. Replace any damaged or broken cables.
2. Check that all terminal connections are tightened to proper torque specification as described in **TABLE 2**.
3. Fully charge batteries.
4. Let batteries rest for at least 8 hours once charging is complete.

## 6.2 - OPEN CIRCUIT VOLTAGE TEST

1. Check and record open circuit voltage (O.C.V.) of each battery.
2. If all of the batteries are below 2.0V (2V battery), 6.1V (6V battery), 8.1V (8V battery), 12.2V (12V battery), or 16.3V (16V battery) the set has failed. Replace the entire set of batteries. In this situation, the battery set has either provided all of its available energy or was severely abused.
3. Otherwise, any battery that is 0.15V lower than the highest battery voltage (2V battery), 0.25V lower than the highest battery voltage (6V battery), 0.35V lower than the highest battery voltage (8V battery), 0.5V lower than the highest battery voltage (12V battery), 0.7V lower than the highest battery voltage (16V battery), might have failed. Make note of these batteries.

All batteries in a good set should be above 2.1V (2V battery), 6.4V (6V battery), 8.5V (8V battery), 12.7V (12V battery), and 17.0V (16V battery) when fully charged after at least 8 hours of rest.

**6.3 - DISCHARGE TEST** *(if you do not have a discharger, proceed to section 6.4. if you have a Full Throttle series battery, proceed to section 6.5)*

1. Connect and start discharger.
2. Record minutes (runtime) when discharge is complete. Correct runtime minutes for battery temperature using the following formula:

$$M_c = M_r [1 - 0.009 (T-27)]$$

Where ***M<sub>c</sub>*** is the corrected minutes, ***M<sub>r</sub>*** is the minutes recorded and ***T*** is the temperature at the end of the discharge in °C.

3. If the set runs more than 60% of its rated capacity, the batteries are good and the test is complete.
4. If the set runs less than 60% of its rated capacity, reconnect the discharger. While under the discharge load, record the end of the discharge voltage for each battery.
5. The batteries that are 0.5V lower than the highest end of discharge voltage should be noted.
6. If the set delivered less than 60% of its rated capacity, and the same batteries that were noted in **STEP 3** of **SECTION 6.2** were also the ones noted in **STEP 5** of **SECTION 6.3**, those batteries are most likely failed and should be replaced. Follow the replacement instructions in **SECTION 6.6** below.
7. Otherwise, please contact your local Fullriver Battery distributor to review your data in detail. You can also reach technical support by calling **(800) 522-8191** or emailing [help@fullriverbattery.com](mailto:help@fullriverbattery.com). Additional testing may be required depending on your specific application.

### 6.4 - OPTIONAL TEST

After completing **SECTION 6.1** and **SECTION 6.2**, follow these steps:

1. Operate the vehicle/equipment until battery performance decreases.
2. Record voltages during and after operation.
3. Record time and distance of operation.
4. Provide the voltage, time, and distance data to a Fullriver Battery distributor or to Fullriver Battery technical support at **(800) 522-8191** or email [help@fullriverbattery.com](mailto:help@fullriverbattery.com).
5. This data will be analyzed in comparison to what is expected of the vehicle/equipment.

### 6.5 - CCA TEST *(only applicable to Full Throttle series batteries)*

1. Connect and start carbon pile load tester according to CCA rating listed on battery.
2. Record all data during test (start voltage, end voltage, pass/fail, tester model, etc.).
3. Provide the voltage, time, and tester data to a Fullriver Battery distributor or to Fullriver Battery technical support at **(800) 522-8191** or email [help@fullriverbattery.com](mailto:help@fullriverbattery.com).

## 6.6 - BATTERY REPLACEMENT INSTRUCTIONS

As long as it is safe to do so, charge the set of batteries before replacing the failed ones to make sure the good batteries are fully charged.

If possible, replace failed batteries with good batteries around the same age from another piece of equipment. Try to avoid mixing new batteries in equipment with old batteries. Put all new batteries in the same piece of equipment.

## 7.1 - FULLRIVER PRODUCTS

Fullriver Battery produces sealed, maintenance-free batteries that are non-hazardous, non-spillable. During normal operation, our batteries will not release any harmful gases and will not leak any acidic electrolyte into the environment.

Fullriver batteries are classified as safe for air, sea, and ground transportation. They meet all requirements of the International Air Transport Association (I.A.T.A.), the International Civil Aviation Organization (I.C.A.O.), the International Maritime Dangerous Goods (I.M.D.G.), and the Department of Transportation (D.O.T.).

More than 98% of the lead in batteries is recycled - placing lead-acid batteries at the top of the list of most highly recycled consumer products. The recycling loop of a lead-acid battery goes on indefinitely.

## 7.2 - FULLRIVER MANUFACTURING

Fullriver Battery manufactures batteries in accordance with international environmental regulations. We continually improve our process in order to minimize waste, recycle all waste that is recyclable and discard waste that is not recyclable in accordance with local disposal regulations. We strictly enforce the use of proper ventilation and protective gear. This enforcement helps minimize employee exposure to lead at a point well below suggested levels.

## 7.3 - SOLAR SETTING RECOMMENDATIONS

Fullriver Battery has a significant presence and history in the residential, commercial, and RV solar markets. From this history, we provide the following recommendations on charge controller and inverter settings:

### 7.3.1 - VOLTAGE SETTINGS

Please see tables 6 & 7 on Page 11 for bulk, absorption, and float voltage recommendations.

Rebulk Voltage should be set low enough to not cause two charge cycles in one day, typically 12.0, 24.0, or 48.0V. Refloat Voltage should be set slightly under 100% OCV or 12.7, 25.4, or 50.8V.

## 7.3.2 - ABSORPTION SETTINGS

Absorption time varies per installation according to total bank size and total PV kW. Our maximum absorption time is 4 hours, however most installations need 2-3 hours on average. To estimate your rough absorption time, use the following formula:

$$[(AH * DOD) / CHARGE AMPS * 0.85]$$

If your charge controller offers a setting such as Absorb End Amps (Outback) or similar that automatically transfers to float charge based on amps accepted, absorption time should be set to 4 hours and this setting should be set to approximately 1.75% of total bank capacity in Ah.

## 7.3.3 - CHARGE RATE & EQUALIZATION

Charge amps should be set up to 25% of total bank capacity in Ah. The minimum recommended is 10%, but verify that your absorption time will not exceed 4 hours.

Equalization is not recommended for any of our products, please disable equalization or set to the minimum time and voltage equal to absorb. If you experience a significant loss in capacity, please contact our technical support for further support.

## 7.3.4 - DEFAULT SETTINGS

When custom settings are not available, please use the following options:

Manufacturer	Setting(s)
Magnum Energy	<b>AGM 2</b>
Midnite Solar	<b>Switch 1-2: OFF/OFF, Switch 5-8: OFF/ON/ON/OFF</b>
Schneider/Xantrex	<b>AGM</b>

TABLE 13

## 7.3.5 - INVERTER SETTINGS

Low Voltage Cut Off or Low Battery Cut Out (LVCO/LBCO) will vary based on how large your loads are and may require adjustment if your runtime is too short.

Depth of Discharge	12 Volt	24 Volt	48 Volt
25%	12.5 V	25.0 V	50.0 V
50%	12.2 V	24.4 V	48.8 V
80%	11.8 V	23.6 V	47.2 V

TABLE 14

If you have a charge controller setting not listed above, you may call our technical support at (800) 522-8191 with your charge controller's make/model and our staff will assist you further.

## Transportation Information

Fullriver DC, Full Force, and Full Throttle batteries are sealed lead-acid batteries made with Absorbent Glass Mat (AGM) technology. The electrolyte is absorbed into the fiberglass separator material rather than in a free-flowing liquid form.

Fullriver DCG and FSG batteries are sealed lead-acid batteries made with gelled electrolyte technology. The electrolyte is suspended in a thixotropic gel applied to the plates rather than in a free-flowing liquid form.

Fullriver batteries are non-spillable electric storage batteries. They are exempt from the requirements of DOT's hazardous materials regulations since they adhere to the requirements of code 49 CFR Section 173.159(D), which states:

**A non-spillable, wet, electric storage battery is exempt from all other requirements of this sub-chapter under the following conditions:**

- *The battery must be protected against short circuits and securely packaged*
- *The battery and outer packaging must be plainly and durably marked "NON-SPILLABLE" or "NON-SPILLABLE BATTERY"*
- *The battery must be capable of withstanding the Vibration and Pressure Differential test specified in 49 CFR 173.159(d)(3)(i) and 49 CFR 173.159(d)(3)(ii); and*
- *At a temperature of 131°F (55°C), the battery must not contain an unabsorbed, free-flowing liquid, and must be designed so that electrolyte will not flow from a ruptured or cracked case.*

Fullriver batteries are protected against short circuits and are securely packaged. Both the batteries and the outer packaging are clearly marked "NON-SPILLABLE". Fullriver batteries were tested by a third party lab and determined to be in compliance with DOT regulations as stated in code 49 CFR Section 173.159(D).

Since Fullriver batteries meet all the requirements, they are considered non-hazardous and therefore do not require a UN number or additional DOT hazardous material labeling.

**This notice is to clarify to shippers and transporters that our batteries are packaged and marked in accordance to 49 CFR 173.159(D) and are determined to be in compliance with DOT HMR49 Non-Hazardous Materials, and the International Air Transportation Association (IATA), Special Provisions S.P. A67 & A48.**

**Therefore, Fullriver batteries are not restricted for shipment by air or any other means of transportation and are exempt from the hazardous material category.**

**A.1 - TEMPERATURE RANGES**

Condition	Recommended	Maximum
Storage	5°F to 122°F (-15°C to 50°C)	-40°F to 160°F (-40°C to 71°C)
Operation	5°F to 104°F (-15°C to 40°C)	-40°F to 160°F (-40°C to 71°C)
Charge with TC	5°F to 122°F (-15°C to 50°C)	-40°F to 160°F (-40°C to 71°C)
Charge w/o TC	32°F to 104°F (0°C to 40°C)	5°F to 122°F (-15°C to 50°C)

**A.2 - STATE OF CHARGE (S.O.C) VS. OPEN CIRCUIT VOLTAGE (O.C.V.)**

State of Charge (S.O.C.)	Open Circuit Voltage (O.C.V.)				
	2V	6V	8V	12V	16V
100	2.14	6.42	8.56	12.83	17.11
90	2.12	6.36	8.48	12.72	16.96
80	2.10	6.30	8.40	12.60	16.80
70	2.08	6.24	8.32	12.47	16.63
60	2.06	6.17	8.23	12.34	16.45
50	2.03	6.10	8.14	12.20	16.27
40	2.01	6.03	8.04	12.06	16.08
30	1.99	5.96	7.94	11.91	15.88
20	1.96	5.88	7.84	11.76	15.68
10	1.94	5.81	7.74	11.61	15.48

At 80°F (27°C)

**A.3 - BOLT & NUT SPECIFICATIONS**

Model	Size x Thread Pitch	Length / Max Insert
FT100, FT185, FT230, FT230D, FT265	6MM x 1	12MM / 9.5MM
DC35, DC55, DC85, FT438, FT620	6MM x 1	16MM / 13.5MM
DC105, DC140, DC245, DC400, FT410, FT410R, FT560, FT825, FT930	8MM x 1.25	16MM / 13MM
DC210, DC260	8MM x 1.25	25MM / 19MM
DC1150	10MM x 1.5	16MM / 12.5MM
All Other DC Models, All Other FT Models	8MM x 1.25MM	20MM / 17MM

**fullriverbattery.com**

3823 MISSION OAKS BLVD, STE A  
CAMARILLO, CA 93012

800.522.8191 (TOLL FREE)  
805.484.7900 (LOCAL / INT'L)



**FULLRIVER**  
BATTERY

