

THE ORIGINAL
Equal-i-zer®
 SWAY CONTROL HITCH

75
 YEARS OF
 SAFETY

Owner's Manual
 For 16k Hitches



HD for 2 1/2" Receivers

Model	Max tongue wt	Max trailer wt
90-00-1600	1600 lb	16,000 lb

Hitch Ball Not Included

MADE
 IN THE
USA



**READERS' CHOICE
 GOLD
 AWARD
 WINNER
 2012 - 2020**

The Best Protection for your Journey.™

Table of Contents

Thank You	3
Parts Breakdown.....	4
Safety Information.....	6
Installation	7
Step 1 – Ready the Tow Vehicle and Trailer.....	7
Step 2 – Install the Hitch Ball	7
Step 3 – Attach the Hitch Head to the Shank	8
Step 4 – Assemble the Sway Brackets	9
Step 5 – Install Spring Arms.....	11
Step 6 – Set Up Weight Distribution.....	11
Step 7 – Adjust Weight Distribution	14
Step 8 – Adjust Trailer Pitch.....	15
Step 9 – Final Tightening	16
Maintenance and Care.....	16
How to Hitch	17
How to Unhitch.....	17
Appendix – Using a Weight Distribution Hitch with Auto-Leveling Suspensions	18
Step 1 – Ready the Tow Vehicle and Trailer.....	18
Steps 6 and 7 – Set Up and Adjust Weight Distribution	18
Step 8 – Trailer Pitch Adjustment.....	18
Hitching Up and Unhitching	18
Customer Support	19
Warranty	19

Read the entire manual before starting installation.

Dealers: Please give this manual to your customer after hitch installation.



Thank You

Welcome to the family! We've been making The Original Equal-i-zer® Sway Control Hitch for 75 years. Thank you for putting your trust in our towing products. Our goal is safe and happy customers.

The Equal-i-zer hitch is known for high performance, quality, and longevity. You can trust the Equal-i-zer's performance. It is the only hitch with Integrated 4-Point Sway Control™. Equal-i-zer's performance gives you the best protection for your journey.

You can trust Equal-i-zer's quality. Each hitch is manufactured in the USA from start to finish with 100% American-made steel and is backed by a lifetime warranty.

You can trust Equal-i-zer's longevity. For 75 years, we've been completely focused on weight distribution and sway control. Nobody knows more about this than us.

The Equal-i-zer hitch is America's Favorite Hitch. Your hitch has received the Trailer Life Magazine Readers' Choice Gold Award nine years in a row by trailer owners across North America and is the only hitch to have ever received the gold award.

Whether you are a first-timer or a full-timer, we are here to help. There are several ways to connect with us. Visit our website www.equalizerhitch.com for videos and resources to help you install your hitch, adjust your hitch, and tow safely.

Our customer service team is also ready to help. Please call us at 800-478-5578, send us an email at support@equalizerhitch.com, or use the chat feature on our website. Our team is available Monday through Friday 8AM to 5PM (Mountain Time). We can also be found on social media platforms such as Facebook, YouTube, Twitter, and Instagram. Please join our community and connect with us.

Thanks again for buying America's Favorite Hitch. We are grateful to be part of your journey.

Parts Breakdown

Parts Breakdown

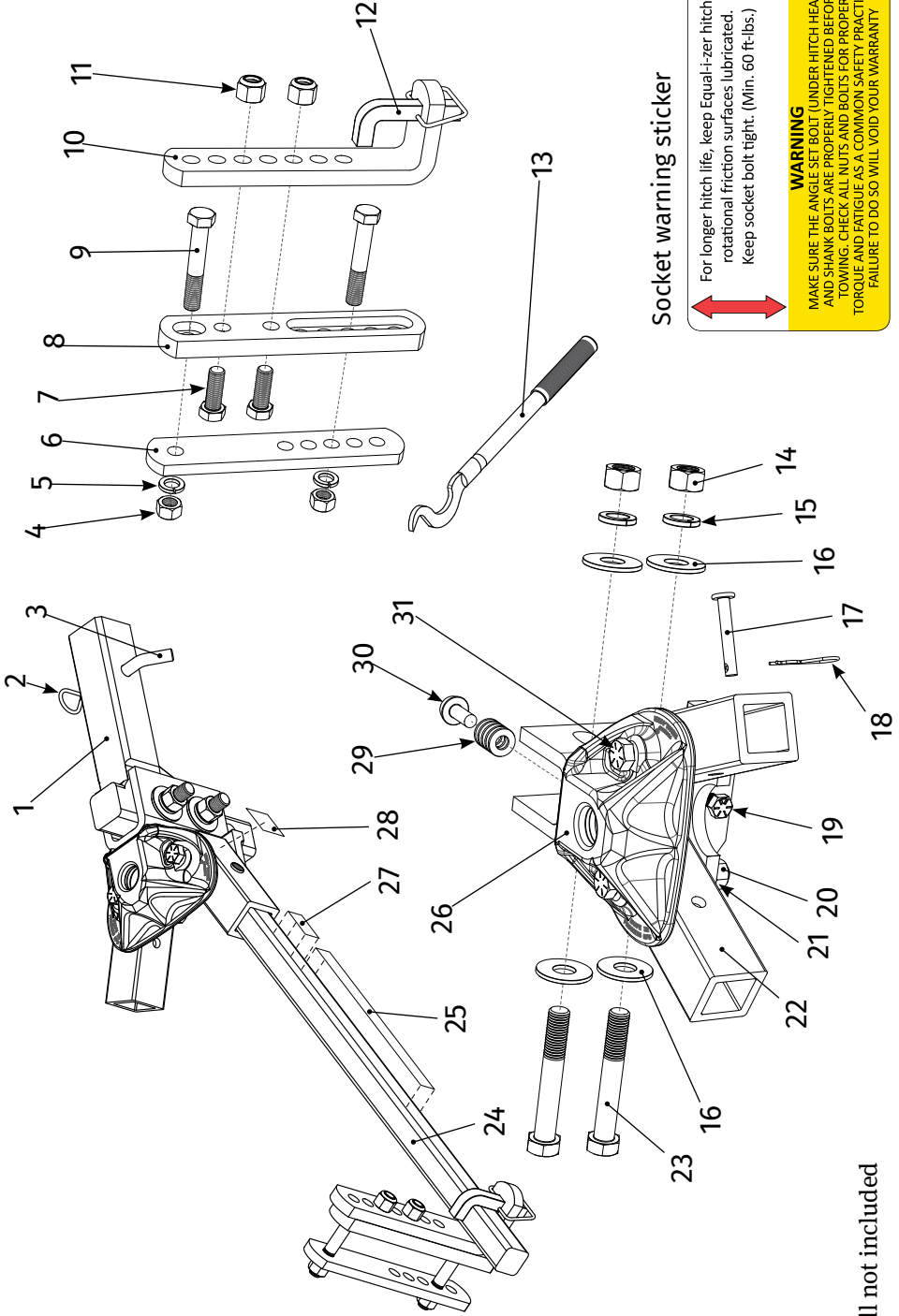

Hitch ball not included

Item#	Part Number*	Part Description	Qty.
1	90-02-4700	Adjustable shank (2-1/2")	1
2	90-04-9224	Hitch pin clip	1
3	90-03-9220	Hitch pin	1
4	90-03-9425	5/8"-11 nut (grade 5)	4
5	90-03-9420	5/8" split lock washer	4
6	90-02-5216	16K inside link plate	2
7	90-03-9655	5/8"-11 x 1-3/4" bolt (grade 5)	4
8	90-02-5316	16K outside link plate	2
9	90-03-9611	5/8"-11 x 3-3/4" bolt (grade 5)	4
10	90-02-5116	16K L-bracket	2
11	90-03-9633	5/8"-11 hex nylock nut (grade 5)	4
12	90-03-9230	Snap L-pin	2
13	95-01-6000	Snap-up lever (complete)	1
14	90-04-9126	3/4"-10 nut (grade 8)	2
15	90-04-9120	3/4" split lock washer	2
16	90-04-9115	3/4" hardened flat washer zinc	4
17	90-03-9212	Socket pin	2

Part number displayed is for single (1) individual piece.

Each complete hitch contains two spring arms. These arms are specifically sized for a hitch head of the same rating. Spring arms will not fit a hitch head of a different rating.

Spring arm sticker example

ATTENTION
It is the driver's responsibility to ensure proper hitch, spring, shank, and tow vehicle use, and to make adjustments to other towing habits, trailer, tow vehicle, and towing equipment to avoid trailer sway. Trailer sway has many causes, including improper trailer loading, tire pressure, driving techniques, and wind gusts. Always use proper hitching and unhooking techniques. There is no safe, subjective measurement of trailer sway or sway control. Users must exercise caution at all times while towing a trailer and abide by all traffic laws.

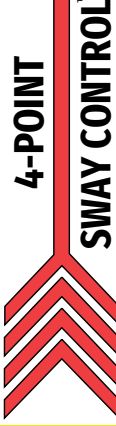

MADE IN THE USA
Model# 90-00-1000
Max. Tongue Weight 1,000 lb
Max. Trailer Weight 10,000 lb
Meets 5th Wheel
Equal-i-zer® is a product
of Equal-i-zer Hitch Systems, Inc.
For a copy of the hitch instructions call
1-800-428-0039 or visit
equalizerhitch.com
61105903

Item#	Part Number*	Part Description	Qty.
18	90-04-9216	Socket pin clip	2
19	90-03-9708	1/2"-20 x 1-3/4" angle set bolt (grade 8)	1
20	90-03-9525	5/8"-11 nut (grade 8) blk. oxide	2
21	90-03-9510	5/8" split lock washer blk. oxide	2
22	90-03-1600	16K socket	2
23	90-04-9131	3/4"-10 x 5" bolt (grade 8)	2
24	90-02-1699	16K spring arm	2
25	BD164	16K arm sticker	2
26	90-02-1600	16K hitch head	1
27	BD020	New owner information sticker	2
28	BD035	Socket warning sticker	2
29	90-04-9110	1/2" hardened flat spacer washer	8
30	90-03-9105	Spacer (pan) rivet	1
31	90-03-9508	5/8"-11 x 4-1/2" bolt (grade 8) blk. oxide	2

Safety Information

⚠ WARNING

Failure to follow all safety warnings may result in severe injury or death.

- Always adjust equipment and driving habits to match towing conditions. The driver is responsible for their own safety and the safety of their passengers.
- Always check all hardware before each trip. Never tow your trailer until all bolts and nuts have been checked for wear and fatigue, are properly tightened, and all pins and clips are secured.
- Always load the trailer correctly. Follow the trailer and tow vehicle manufacturers' recommendations for placement and quantity of cargo.
- Always use a hitch ball with a rating that equals or exceeds the trailer Gross Vehicle Weight (GVW). Always use a hitch ball size that correctly matches your trailer coupler size and make sure it is coupled securely before towing.
- Never cut, weld, grind, bend, or modify hitch components in any way.
- Never exceed the specified weight ratings for the trailer, tow vehicle, hitch, hitch ball, or any other towing equipment.
- Never tow with your hitch adjusted incorrectly.
- Never tow with your hitch engaged on rough roads, through profound ditches and dips, or while launching a boat. Excessive strain on the spring arms and hitch head may cause hitch fatigue or failure.
- Never transfer your hitch to a different tow vehicle or trailer without adjusting the hitch for proper setup and weight distribution.
- No hitch setup guarantees that trailer sway will be altogether avoided.
- Read, understand, and follow all safety warnings, setup, use, and maintenance instructions of the trailer, tow vehicle, and hitch equipment before installing the hitch or towing your trailer.
- Replace worn, faded, or unreadable warning stickers on the spring arms and arm sockets.
- The operator is responsible for making necessary adjustments to the hitch to optimize weight distribution and sway control. Verify that the hitch is adjusted correctly after loading the trailer and tow vehicle for each trip. The weight distribution setup and towing performance should be evaluated by the operator and adjusted when necessary.
- Towing with a tongue weight that is not within 10 – 15% of your Gross Trailer Weight (GTW) increases the likelihood for loss of vehicle control and/or equipment failure.

⚠ CAUTION

- Always secure the tow vehicle and trailer with the parking brake and wheel chocks before setting up or adjusting the hitch.
- Disengage weight distribution before towing or backing the trailer where there is a significant transition in grade, for example, backing from a level street onto a driveway with a steep uphill slope. Failure to disengage the hitch will put excessive strain on the trailer and receiver hitch.
- Never loosen or remove any part of the hitch while the hitch is under load. Use the tongue jack to take the tension off the spring arms before removing the L-pins.

Installation

Step 1 – Ready the Tow Vehicle and Trailer

Park the trailer and tow vehicle on flat, level ground and in line with each other. Chock the trailer.

For accurate installation the tow vehicle and trailer should be loaded just as they will be while traveling. This includes propane, water, ATVs, generators, and any other cargo that the tow vehicle or trailer will carry.

Check and inflate all tires to their proper pressure.

Tow vehicle auto-level systems should be disabled or turned off temporarily. Auto leveling and air suspension systems will decrease the amount of weight distribution provided by the hitch after setup. See Appendix for more information.

Step 2 – Install the Hitch Ball

Tools needed:

- Torque wrench capable of 430 ft-lbs
- 1 7/8" Thin walled socket
- 1 3/4" Box end wrench

WARNING

Never exceed the specified weight ratings for the trailer, tow vehicle, hitch, hitch ball, or any other towing equipment.

NOTICE

Using a hitch ball with a threaded shank longer than 2 3/8" may damage the Equal-i-zer hitch head and could void your warranty.

Select a ball with a 1 1/4" diameter threaded shank, no longer than 2 3/8". The weight rating must equal or exceed your trailer's gross vehicle weight (GVW). Torque the nut to the manufacturer's specifications.

Equal-i-zer brand hitch balls should be tightened to 430 ft-lbs with a 1 7/8" thin walled socket. Contact an authorized Equal-i-zer hitch dealership for service appointments and cost if you need help installing the hitch ball.

Equal-i-zer Hitch Balls

Part Number	Size	Weight Rating
91-00-6080	2"	8,000 lbs
91-00-6100	2 5/16"	10,000 lbs
91-00-6120	2 5/16"	12,000 lbs
91-00-6140	2 5/16"	14,000 lbs
91-00-6160	2 5/16"	16,000 lbs

Step 3 – Attach the Hitch Head to the Shank

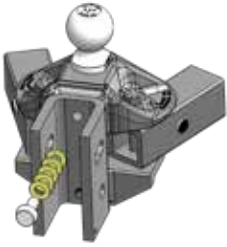

Figure 1

Tools Needed:

- Torque wrench capable of 320 ft-lbs
- 1 $\frac{1}{8}$ " Socket with ratchet (Shank bolts)
- $\frac{3}{4}$ " Socket or box-end wrench (Angle set bolt)

Level the Trailer (Parallel to the Ground)

Measure to the ground at the front and back of the trailer frame and adjust the trailer to be parallel to the ground. Both front and back measurements should be the same.

Attach Head to Shank

1. Insert the adjustable shank into the receiver on the tow vehicle and secure it with the hitch pin.
2. Insert the spacer rivet with washers into the back of the hitch head. Start with 6 spacer washers for most setups. (Figure 1)
3. Slide the hitch head onto the shank with the top of the hitch ball between 0 – 1" above the top of the trailer coupler. (Figure 2) In some cases you may need to turn the shank upward or use a bigger rise/drop Equal-i-zer shank to place the hitch ball at the correct height. (Figure 3)
4. Use the $\frac{3}{4}$ " bolts, flat washers, lock washers and nuts to secure the head to the shank at the correct height. Hand tighten the nuts. (Figure 4)
5. Use a wrench to tighten the angle set bolt until the spacer rivet is firmly against the shank. (Figure 5)

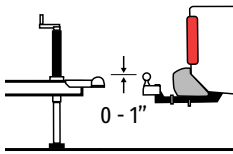

Figure 2

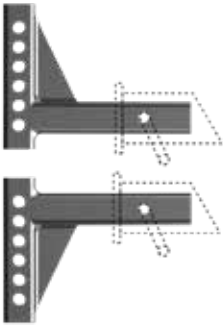

Figure 3

Reduced Turning Radius

Extended bumper guards, truck campers or rear mounted spare tires can limit your turning radius. In a tight turn this can lead to a collision between your tow vehicle and trailer. If you are not able to turn tightly with the standard length (12") shank, consult with your dealer about purchasing a longer (18") Equal-i-zer shank. Certain trailer configurations and safety chain orientation can reduce the amount of clearance needed for safe towing. Check these items first to ensure proper clearance.

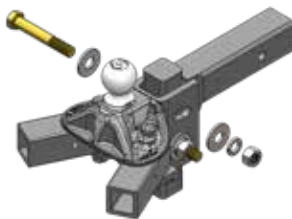

Figure 4

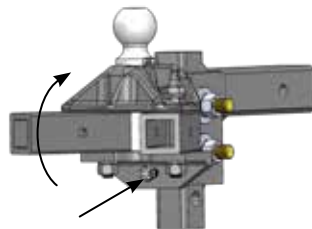

Figure 5

Step 4 – Assemble the Sway Brackets

Tools Needed:

- $\frac{15}{16}$ " Box-end or socket wrench (Link plates and L-brackets)
- Torque wrench capable of 130 ft-lbs.
- Measuring tape

Sway Bracket Location

1. Install the bracket assemblies between 27" – 32" from the center of the coupler. (Figure 6) This range should allow you to avoid most obstructions on the trailer tongue like battery supports or propane tanks.
2. Measure along the frame from the center of the coupler to the center of the brackets.
3. Both brackets should be the same distance from the coupler.
4. If necessary, relocate items on the frame to allow installation of the brackets within this range.

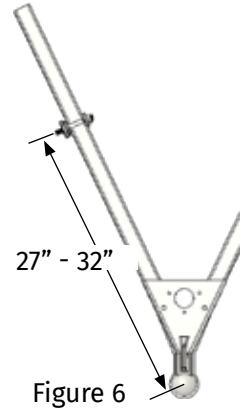

CAUTION

Do not use an impact wrench to tighten the link plate or L-bracket bolts.

Assemble the Link Plates

Partially assemble the brackets:

1. Place two $\frac{5}{8}$ " x $1\frac{3}{4}$ " L-bracket bolts through the middle holes of the thicker outside link plates.
2. Place a $\frac{5}{8}$ " x $3\frac{3}{4}$ " frame bolt through the single holes at the top of each link plate.
3. The bolt heads should fit completely into the recessed slots.
4. Slide a $\frac{5}{8}$ " split washer onto the frame bolts and thread on a $\frac{5}{8}$ " nut a few turns. Do not use lock nuts on these bolts. (Figure 7)

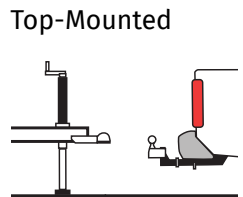
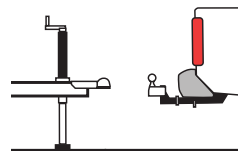

Figure 8

Identify your coupler style and follow the correct step for your style. (Figure 8)

Typical Installation – Top-mounted Couplers

1. Slide the link plate assembly down over the frame hanging from the top bolt.
2. Insert the second $\frac{5}{8}$ " x $3\frac{3}{4}$ " bolt through the open hole closest to the bottom of the trailer frame. (Figure 9)
3. Insert the bolt head into the slot and add a $\frac{5}{8}$ " lock washer and thread a $\frac{5}{8}$ " nut onto the end of the bolt.



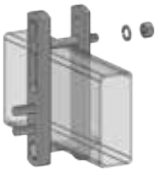

Figure 10

Inverted or Upside-Down Installation – Bottom-mounted Couplers, V-nose Trailers

Install the assembly upside-down if you have a trailer with a bottom-mount coupler, V-shaped nose, or any other obstacle that prevents them from being installed right-side up.

1. Slide the assembly up around the frame until the bolt hits the bottom of the trailer frame.
2. Insert the second $\frac{5}{8}$ " x $3\frac{3}{4}$ " bolt through the open hole closest to the top of the trailer frame. (Figure 10)
3. Insert the bolt head into the slot and add a $\frac{5}{8}$ " lock washer and thread a $\frac{5}{8}$ " nut onto the end of the bolt.

No Gaps

For either typical or upside-down installation there should not be a gap between the trailer frame and the link plate bolts either above or below the trailer frame. Move electrical or propane lines if necessary. (Figures 11a – 11d)

Pinch the link plates flat against the sides of the trailer frame, and hand tighten both nuts. (Figure 12)

When the nuts have been tightened by hand and both link plates are held flat against the frame, use a torque wrench to tighten all the link plate bolts to 130 ft-lbs.

L-bracket Installation

Place the L-bracket onto the outside link plate with the bolts in the two middle holes. Thread on the nylock nuts and hand tighten them until the L-brackets are held firmly in place. (Figures 13, 14)

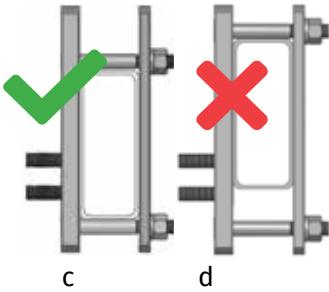
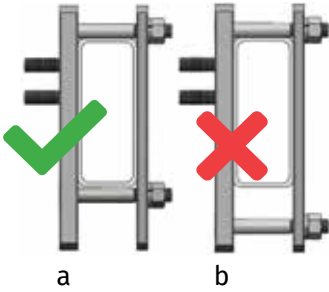

Figure 11

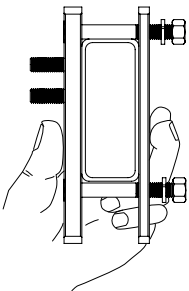

Figure 12

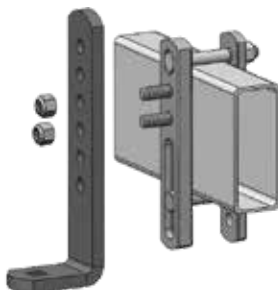

Figure 13

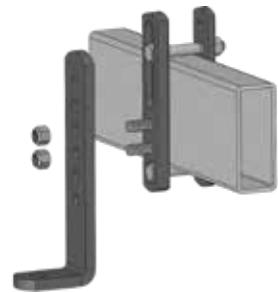

Figure 14

Step 5 – Install Spring Arms

⚠ WARNING

Never tow with loose socket bolts. Tighten socket bolts to a minimum of 60 ft-lbs before you tow.

⚠ NOTICE

Do not pound directly on the sockets to move them. Pounding may cause the sockets to crack or chip. Use only the lever force of the spring arm to rotate tight sockets. Loosen the socket bolt if required when new, to break free from the paint. Retighten them once the socket has been moved.

The spring arms for the 16k hitch are side specific. Insert the spring arms into the hitch head with the notched ends inside the sockets and the labels facing outward. Pin them in place using the socket pins and clips. (Figure 15)

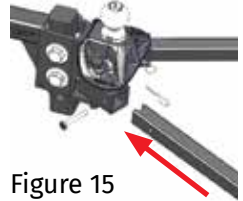

Figure 15

Step 6 – Set Up Weight Distribution

Tools Needed:

- Measuring tape
- Pencil

Good weight distribution is a critical component of the Equal-i-zer hitch setup. To ensure proper weight distribution, measure the front wheel well of the tow vehicle three times in these different vehicle configurations:

1. Measure without the trailer coupled.
2. Measure with the trailer coupled with the spring arms unattached.
3. Measure with the trailer coupled and the spring arms attached.

For best accuracy, measure both the driver and passenger wheel wells and use the average of these two measurements for the calculations. (Figure 16)

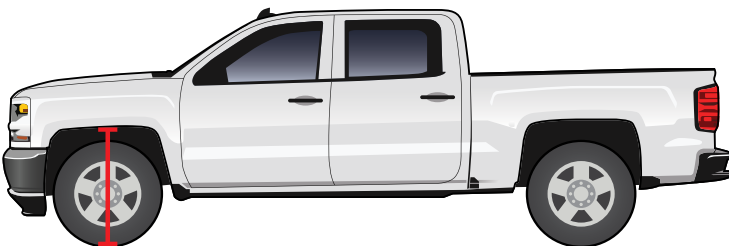

Figure 16

Measure from the ground to the wheel well through the center-line of the axle

Weight Distribution Calculation Table

Weight Distribution Setup Table	Front Wheel Well Height	Example
A - Uncoupled from trailer (Figure 17)		30"
B - Trailer coupled and on hitch ball without weight distribution (Figure 18)		31"
C - Fully hitched up with weight distribution engaged (Figure 23)		30 1/4"
Calculated weight distribution: $100 * (B-C) / (B-A)$		75%
Target Between 50-100%		

A – Measure from the ground to the bottom of the tow vehicle driver side front wheel well, and record the distance on **line A** of the weight distribution calculation table. (Figure 17)

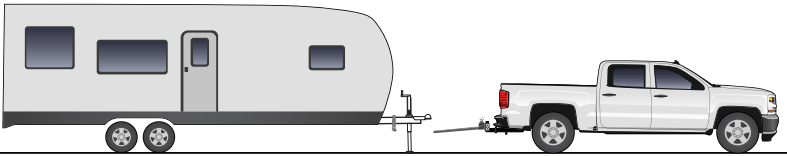

Figure 17

B – Lower the trailer onto the hitch ball and lock the coupler. The full weight of the tongue should be resting on the hitch. Measure from the ground to the bottom of the tow vehicle driver side front wheel well. Record this distance on **line B** of the weight distribution calculation table. (Figure 18)

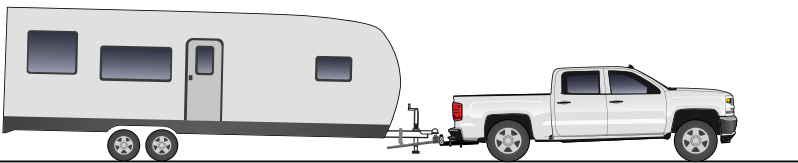

Figure 18

C – With the trailer still coupled, use the tongue jack to lift both vehicles until the spring arms can swing onto the L-brackets. (Figure 19) If needed, use the Snap-up lever to lift the spring arms onto the L-brackets. (Figure 20) Insert the L-pins and secure them in place. (Figure 21)

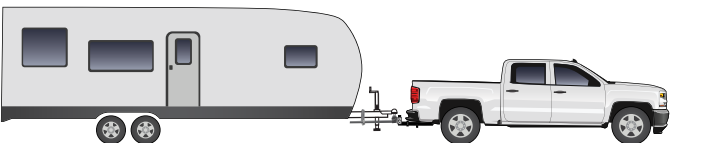

Figure 19



Figure 20

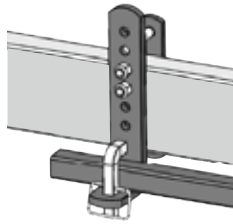

Figure 21

Retract the jack until the full weight of the trailer tongue is on the hitch. Verify that there is a minimum of 3" from the end of the spring arms to the center of the L-bracket. (Figure 22) If there is less than 3" the brackets must be moved forward. Disconnect the hitch and move the brackets forward.

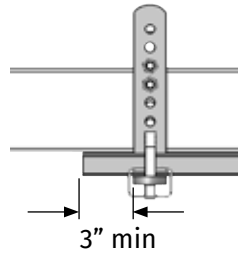

Figure 22

With the trailer coupled and weight distribution engaged (spring arms in place and jack retracted), measure from the ground to the bottom of the tow vehicle driver side front wheel well. Record this distance on **line C** of the weight distribution calculation table. (Figure 23)

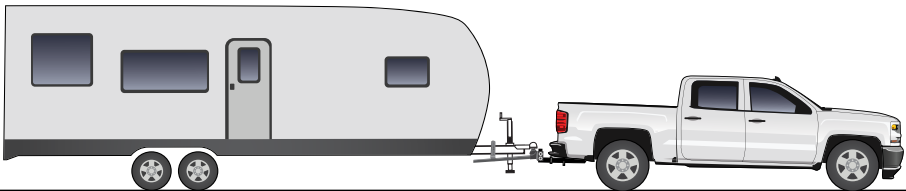

Figure 23

To calculate the weight distribution percentage – find the difference between B and C, then divide by the difference between B and A, then multiply the result by 100.

Step 7 – Adjust Weight Distribution

⚠ WARNING

Weight distribution is one of the many things that reduces sway. The operator is responsible for making other necessary adjustments to all contributing factors to minimize sway.

Good Weight Distribution Range

Good weight distribution adjustment is achieved if your calculated weight distribution falls between 50 – 100%. Every tow vehicle and trailer combination will be different. Refer to your tow vehicle owner's manual for exact ratings. Do not exceed 100% weight distribution. (Figure 24)

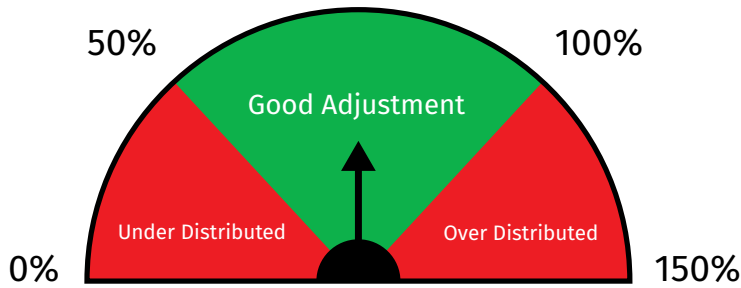

Figure 24

Under or Over Distributed

Under Distributed means less than 50% weight distribution after installation (or less than the minimum directed by the tow vehicle owner's manual), measured at the front axle of the tow vehicle. In this case, there is too much weight on the rear axle and not enough weight on the front axle. This can cause a loss of steering and braking control with reduced resistance to trailer sway. **To correct under distribution, add more spacer washers to the hitch head or raise the L-brackets.**

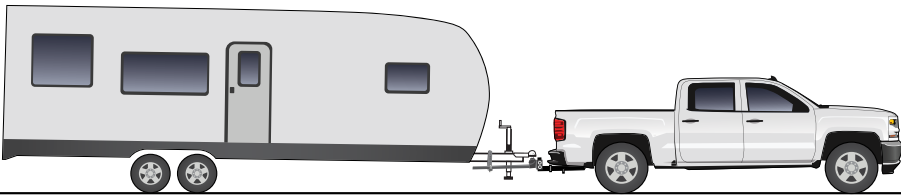

Figure 25 - Under Distributed

Over Distributed means more than 100% weight distribution return (or more than the maximum directed by the tow vehicle owner's manual), measured at the front axle of the tow vehicle. Over-distribution can remove too much weight from the tow vehicle's rear axle. This can cause a loss of traction and control causing jack-knifing, especially in slick road conditions. **To correct over distribution, remove spacer washers from the hitch head or lower the L-brackets.**

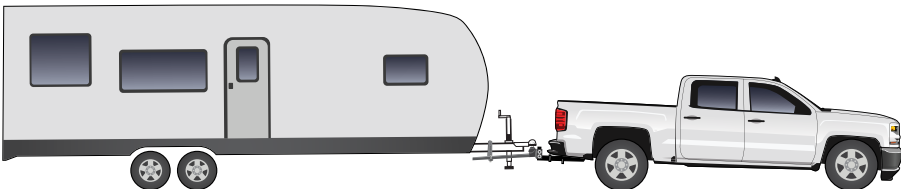

Figure 26 - Over Distributed

Make Weight Distribution Adjustments

1. Use the tongue jack to raise both vehicle and trailer.
2. Unload and remove the spring arms.

3. Unhitch the trailer, then change the number of spacer washers and/or the position of the L-brackets.
4. Hitch the trailer again and engage the spring arms.
5. Retract the jack so the hitch is carrying the trailer weight.
6. Measure the front fender and enter this new distance on line C of the weight distribution calculation table.
7. Calculate the new weight distribution amount using the previous distances for lines A and B, and the new distance for line C.
8. Repeat Step 7 until the measurements show that the hitch is distributing weight correctly.

Step 8 – Adjust Trailer Pitch

After achieving good weight distribution, you may need to adjust the pitch or angle of the trailer to make it level (parallel to the ground) while towing. Measure from the ground to the front and rear of the trailer frame.

If the difference between the front and rear measurements is more than 1 ¼” adjust the hitch ball height. Move the hitch head up or down on the shank as needed. If the difference is less than 1 ¼” complete Step 9 and tow a short distance with this setup to see how it handles before making any adjustments.

After making any adjustments to the ball height, fully hitch and engage the spring arms and remeasure the front wheel well, for line C of the weight distribution table. Update line C and calculate the new weight distribution percentage using the previous measurements for lines A and B.

Make more adjustments if needed until both the weight distribution is correct, and the trailer is level (parallel to the ground).

Step 9 – Final Tightening

After the weight distribution and trailer pitch are correct, all the bolts on the hitch must be tightened completely to their recommended torque specifications.

Torque Specifications in ft-lb

(2) 3/4" Shank bolts	320
(4) 5/8" x 3 3/4" Link plate bolts	130
(4) 5/8" x 1 3/4" L-bracket bolts	130
Socket bolts	60 min; 100 max
Angle set bolt	Set against shank + 1/2 turn

You are now ready to tow the trailer. Remember to remove your wheel chocks, connect the breakaway cable, safety chains, and electrical cable. Adjust your brake controller correctly. Retract the jack completely.

Maintenance and Care

Lubricate here

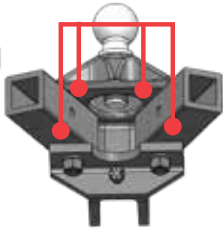

Figure 27

Friction surfaces of the head and sockets should be cleaned and lubricated with a good quality multi-purpose or bearing grease before each trip. This includes the hitch ball. Lubricate the surfaces where the arm sockets rub against the top and bottom plates of the head. (Figure 27) Do not lubricate the swing arms or L-brackets. We recommend Equal-i-zer high performance lubricant. (part # 91-00-4250)

Check for damage or abnormal wear at the beginning of each trip and replace damaged and worn parts as necessary. Clean dirt and debris from all the friction surfaces regularly.

All nuts and bolts should be checked before each trip and tightened if necessary.

Store your hitch out of the weather when not in use. Use a good quality spray paint to touch up the finish and help prevent rust. Do not paint over the warning stickers. If the warning stickers become unreadable, contact Equal-i-zer for a free replacement.

A properly maintained and clean hitch will perform better and reduce wear and towing noise. Equal-i-zer Sway Bracket Jackets may also be used to quiet the ride and reduce wear on the L-brackets.

How to Hitch

1. With the Equal-i-zer hitch head installed, position the hitch ball directly under the trailer coupler. (Figure 28)
2. Lower the trailer coupler until it is resting on the hitch ball. If the trailer coupler won't sit properly, adjust the position of your tow vehicle. (Figure 29)
3. Lock the coupler and insert the safety pin into the coupler latch.
4. Insert the spring arms into the sockets of the hitch head and secure them with the socket pins and clips. Make sure the decal stickers are facing the outside. The 12k and 14k models are side specific. (Figure 30)
5. Raise the trailer jack until you can slide the spring arms onto the L-brackets; if needed, use the Snap-up lever. (Figure 31)
6. Insert the Snap L-pins.
7. With both arms secured, lower the jack, then retract it completely. (Figure 32)
8. Attach the safety chains and breakaway cable.
9. Insert the 7-pin plug. Make sure the plug is clean and free of debris.
10. Remove your wheel chocks.
11. You are ready to go!

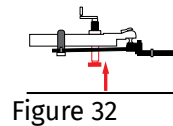
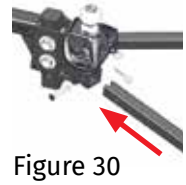
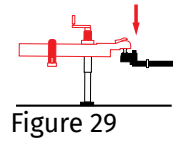
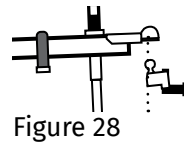

How to Unhitch

1. Properly chock your trailer.
2. Remove the 7-pin plug.
3. Remove the breakaway cable and safety chains.
4. Extend your trailer jack to lift the weight off the hitch spring bars. (Figure 33)
5. With the tension off the spring arms, remove the Snap L-pins and slide the spring arms off the L-bracket. (Figure 34)
6. Remove the socket pins and clips from the sockets in the hitch head.
7. Remove the spring arms from the hitch head.
8. Remove the safety pin and unlock the coupler.
9. Raise the trailer coupler above the hitch ball. (Figure 35)
10. Pull your tow vehicle away slowly, lock your trailer coupler and you are done. (Figure 36)

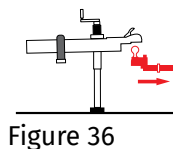
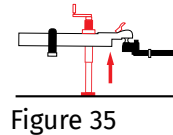
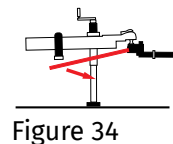
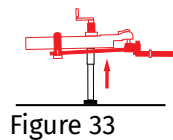

Appendix – Using a Weight Distribution Hitch with Auto-Leveling Suspensions

Always refer to and follow your tow vehicle owner’s manual or air bag instructions for their requirements for use while towing. Auto leveling will greatly affect your towing situation.

Step 1 – Ready the Tow Vehicle and Trailer

Turn off or disable air bag suspension or auto-leveling systems for the hitch setup process. Allow the suspension to adjust to normal position before turning it off. To turn the auto level off, the system may have an off switch, a jack mode setting, or you may need to turn off the vehicle.

Steps 6 and 7 – Set Up and Adjust Weight Distribution

4 Corner Auto-Leveling Suspension:

4-corner auto leveling systems will decrease the weight distribution amount by 20 – 25%. If it is possible to disable the auto leveling so that it remains off while driving, do so. If not, then set up the hitch so that 75 – 100% weight distribution is achieved. This will help compensate for the loss from auto leveling.

Rear Auto-Leveling Suspension:

When using rear auto-leveling suspension systems follow the instructions to Step 6 - line C. Allow the vehicle to auto level the rear before taking measurement C. On hydraulic or pneumatic systems this is done by turning the vehicle on and letting the engine idle while it levels. If your vehicle is equipped with a system that requires the tow vehicle to be driven, mark where it is parked so that you can return to the same spot after driving to take measurement C.

Step 8 – Trailer Pitch Adjustment

After achieving good weight distribution with auto level engaged, the trailer pitch may need to be adjusted. Measure the trailer as described in Step 8 and make any required adjustments to the hitch setup.

Hitching Up and Unhitching

Before hitching or unhitching, turn off the auto-level system by turning off the vehicle or, if equipped, placing the system in jack mode.

Customer Support

If you need customer support, or replacement parts and accessories, please contact our customer support team. Please call us at 800-478-5578, send us an email at support@equalizerhitch.com or use the chat feature on equalizerhitch.com. Our team is available Monday through Friday, 8AM to 5PM (Mountain Time).

Visit our website for our Troubleshooting Guide.
equalizerhitch.com/frequently-asked-questions

Warranty

Limited Lifetime Warranty: Progress Mfg. Inc. warrants the Equal-i-zer® hitch against latent defects in materials and workmanship under normal use and service, ordinary wear and tear is excepted, from the first date of purchase at retail for the ownership life of the original purchaser. If this product is latently defective it will be replaced or repaired when a proper return authorization is obtained, and the product is returned with transportation charges prepaid to Progress Mfg. Inc.

Progress Mfg. Inc. shall not be required to replace or repair any products damaged as a result of improper installation, alteration, unreasonable use, or improper maintenance including, without limitation, loading the product beyond the factory rated load capacity. This warranty does not include labor charges, nor does it include transportation charges for returning the product to the consumer. To the extent allowed by law, Progress Mfg. Inc. shall not be liable for any incidental, consequential, or any other damages including, without limitation, breach of any implied warranty, merchantability, or fitness for a particular purpose of any Equal-i-zer product. In no event shall Progress Mfg. Inc. be liable for any damages other than the replacement or repair of the affected part. Authorization and warranty procedure may be obtained by calling Progress Mfg. Inc. customer support at 800-478-5578.

Go to equalizerhitch.com to register your hitch warranty online.

Find us online

We would love to connect with you. Find us on these social media platforms.

 [youtube.com/equalizerhitch](https://www.youtube.com/equalizerhitch)

 [facebook.com/equalizerhitch](https://www.facebook.com/equalizerhitch)

 twitter.com/equalizerhitch

 [instagram.com/equalizerhitch](https://www.instagram.com/equalizerhitch)

Visit Fastway® Trailer Products at www.fastwaytrailer.com for faster and easier towing solutions.



The Original Equal-i-zer Sway Control Hitch provides superior performance you can trust. No other hitch keeps you safer on the road.

The Equal-i-zer hitch is manufactured in the USA from 100% American-made steel. It is the only hitch with Integrated 4-Point Sway Control - a unique system that integrates sway control and weight distribution into one unit. The result is superior sway control performance, quality, and ease of use.

4-Point Sway Control

With the Equal-i-zer's Integrated 4-Point Sway Control™ you can relax knowing the most advanced towing technology is keeping you safer on the road.

Quality Construction

The Equal-i-zer hitch provides exceptional towing confidence. From the highest-quality steel, to each of its smallest components, the Equal-i-zer hitch is 100% American made.

Weight Distribution

Our patented design transfers trailer tongue weight to all axles, improving steering, stopping, and providing a smooth, level, enjoyable ride.

Ease of Use

The Equal-i-zer hitch is simple and easy to use. Hitching and unhitching are conveniently done from any angle, and adjustments are simple.