

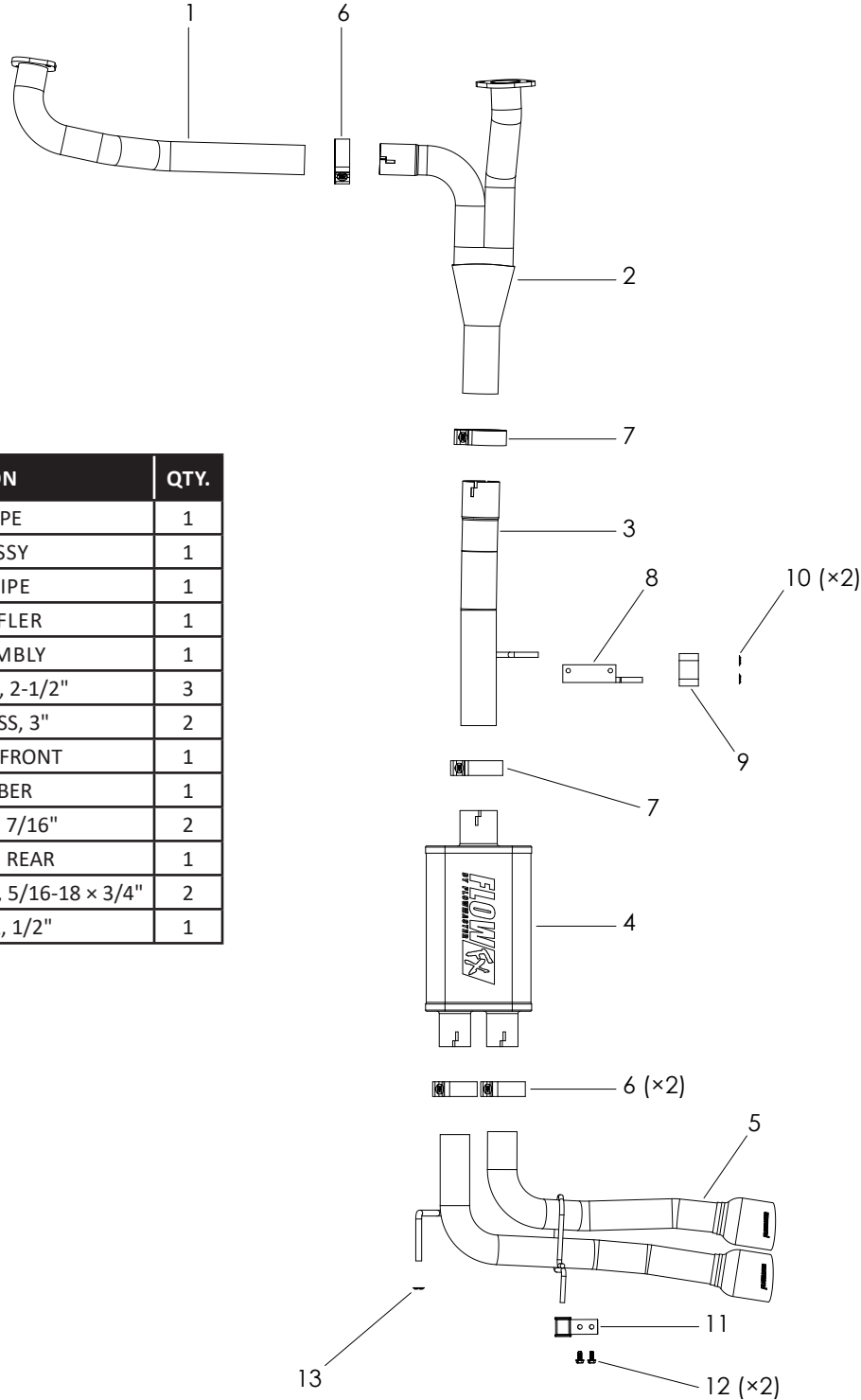

Installation Instructions
718105
2017-2023 NISSAN TITAN w/5.6L ENGINE
2- or 4-WHEEL DRIVE
Short wheelbase only (139.8 in.)
 See "Applications" tab on the product web page for specific applications.



ITEM	PART NO.	DESCRIPTION	QTY.
1	86578M	LEFT HEAD PIPE	1
2	86579M	HEAD PIPE ASSY	1
3	26751M	EXTENSION PIPE	1
4	72198-Z	FLOW FX MUFFLER	1
5	86724M	TAILPIPE ASSEMBLY	1
6	MC250BS	CLAMP, STAINLESS, 2-1/2"	3
7	MC300BS	CLAMP, STAINLESS, 3"	2
8	504HA	FRAME HANGER, FRONT	1
9	HA168	HANGER, RUBBER	1
10	HW502	HANGER KEEPER, 7/16"	2
11	HA572	FRAME HANGER, REAR	1
12	HW225	SCREW, THREAD-CUTTING, 5/16-18 x 3/4"	2
13	HW503	HANGER KEEPER, 1/2"	1

NOTES

- Installation requires moderate mechanical skill. If this job is beyond your abilities, seek the services of a qualified technician.
- If you do not understand any part of these instructions, please call Flowmaster Technical Support at (866) 464-6553 for assistance.
- Apply penetrating oil generously to clamps, fasteners, pipes, and hanger rods for ease of disassembly.

REVIEW THE INSTRUCTIONS & VERIFY THE KIT CONTENTS

Take a moment to read and understand these instructions before installing your Flowmaster FlowFX exhaust kit.



Use the parts drawing and list to verify your kit's contents. In the unlikely event that any parts are missing, please contact Flowmaster Technical Support for replacements.

REMOVE THE FACTORY EXHAUST SYSTEM

WARNINGS

- **AVOID BURNS!** Exhaust systems get extremely hot. Allow the vehicle to cool down fully before starting work.
- **AVOID SERIOUS INJURY OR DEATH BY CRUSHING!** Never work under a vehicle that is supported by jacks.
- **EXHAUST SYSTEM COMPONENTS ARE HEAVY!** Use jack stands to support them, both when removing the stock system, and when installing your new kit.

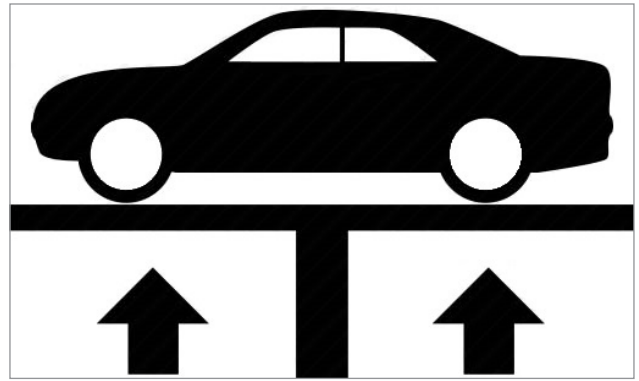

1. **Raise the vehicle** to working height on a lift. If you do not have a lift, securely support the vehicle on jack stands.

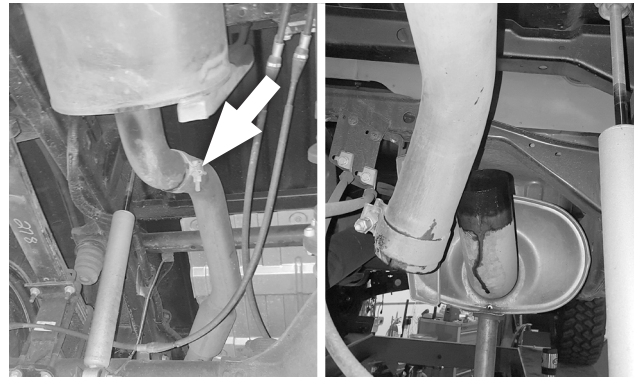

2. **Loosen the clamp behind the muffler**, and separate the tailpipe from the muffler.

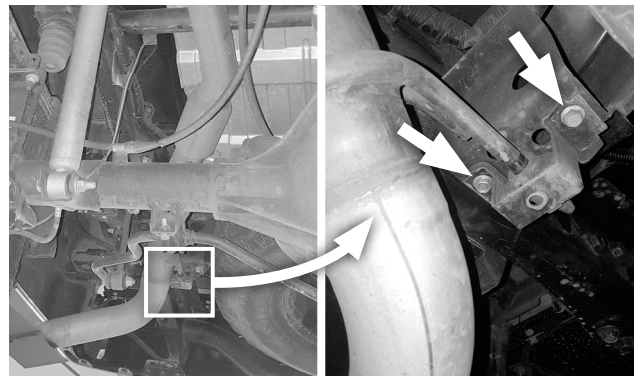

3. **Remove the 2 screws from the tailpipe's isolator mount.** Then remove the assembled tailpipe and mount from the vehicle.

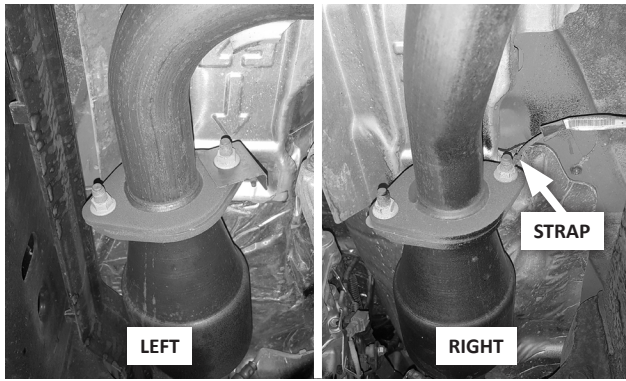

4. Remove and retain the fasteners and gaskets from the 2 flanges where the head pipes meet the catalytic converters. (One of the fasteners may secure a bonding strap.)

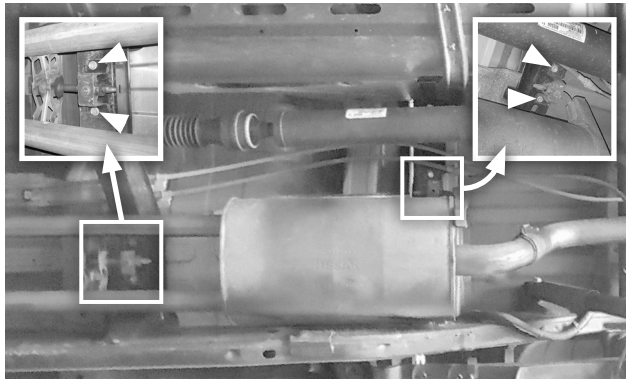

5. Remove and retain the 2 screws from both the front and the rear isolator mounts. Remove the assembled headpipes, muffler, and mounts from the vehicle.

INSTALL YOUR FLOWMASTER EXHAUST SYSTEM



6. Before installing any clamps, remove their nuts, apply anti-seize compound to the bolt threads, and re-install the nuts.

NOTE: All pipe-to-pipe slip-fit connections must seat 3" deep. All pipe-to-muffler connections must seat 2" deep. Mark the male ends of each pipe in advance, to ensure proper insertion during assembly.

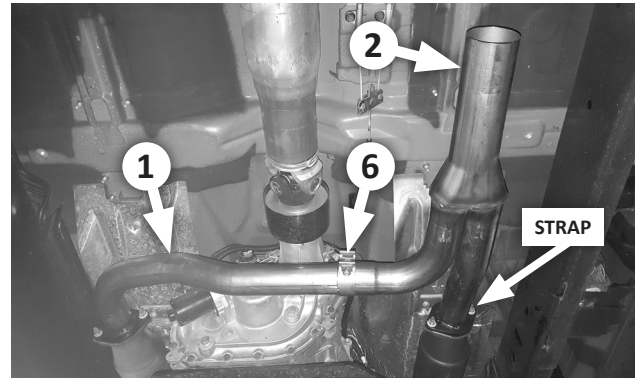

7. Slip a 2-1/2" clamp (6) over the head pipe assembly (2), slip the head pipe assembly over the left head pipe (1), then attach the pipes to the catalytic converter flanges using the stock gaskets and fasteners. (Reattach the bonding strap if applicable.) Verify 3" of insertion, and snug the clamp slightly (just enough to allow final adjustment later).

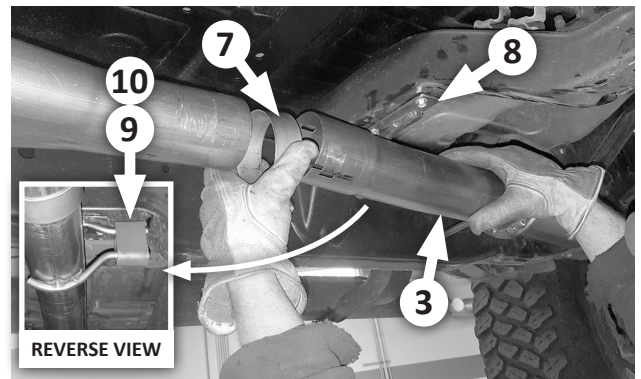

8. Install front hanger bracket (8) with 2 stock screws. Slip a 3" clamp (7) over extension pipe (3), slip the extension pipe over the headpipe, then install rubber hanger (9) on the bracket and pipe's hanger rods. Verify 3" of insertion, and snug the clamp slightly. Install the two 7/16" hanger keepers (10) on the hanger rods.



9. Slip the other 3" clamp (7) over the muffler's (4) inlet. Then install the muffler on the extension pipe and support it with a stand. Verify 2" of insertion, and snug the clamp.

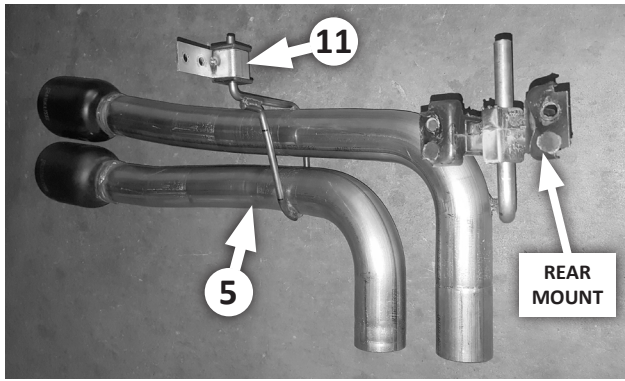

10. Install rear frame hanger (11) on the tailpipe assembly's (5) thin hanger rod. Install the muffler's rear isolator mount (removed at Step 5) on the thick hanger rod.

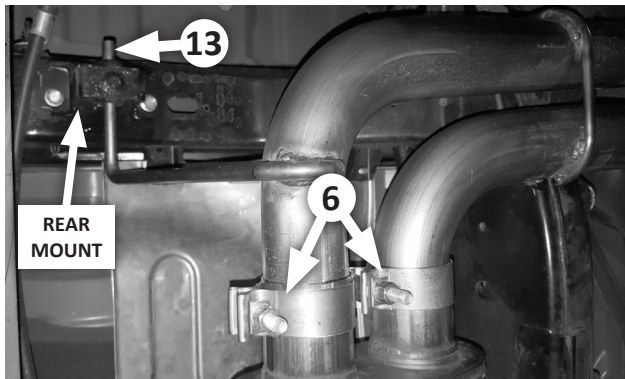

11. Slip two 2-1/2" clamps (6) over the muffler outlets. Insert both tailpipes in the muffler, and fasten the isolator mount to the frame using the stock screws. Verify 2" of insertion, and snug the clamps. Install the 1/2" hanger keeper (13) on the hanger rod.

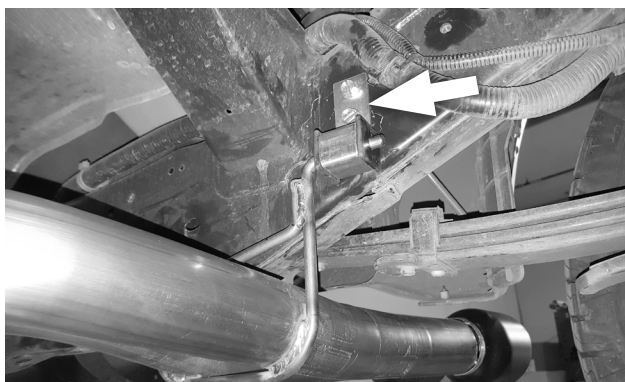

12. Adjust the tailpipe assembly so the pipes clear the frame and the tips are at the desired distance from the body. Lay the rear frame hanger flat against the inside of the truck's frame, and mark the hole locations. Move the bracket aside, drill 1/4" holes at the marks, and fasten the bracket to the frame with the two thread-cutting screws (12).

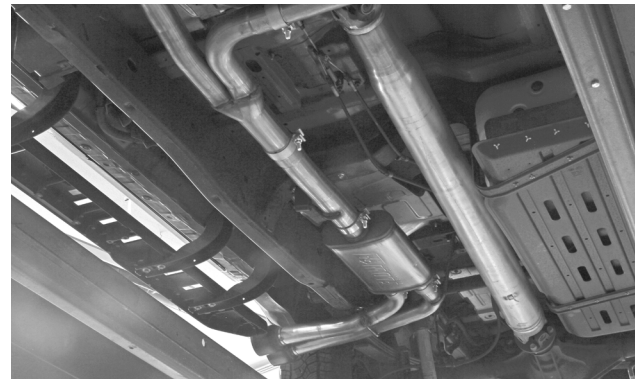

13. Adjust all components to give 1/2" to 3/4" clearance (about a finger's width) around them, and allowing for suspension travel and vibration. When you are satisfied with the system's clearance and fit, tighten all clamps.

RECOMMENDED: Tack weld each slip-fit connection (approx. 1" weld) for added security, then paint each weld with high-temp spray paint to protect against corrosion.



Congratulations, the installation of your Flowmaster FlowFX performance exhaust system is complete!

KEEP THESE INSTRUCTIONS FOR FUTURE REFERENCE

Flowmaster maintains a highly-trained technical service department to answer your technical questions, provide additional product information and offer various recommendations.



FLOWMASTER TECHNICAL SUPPORT: (866) 464-6553