

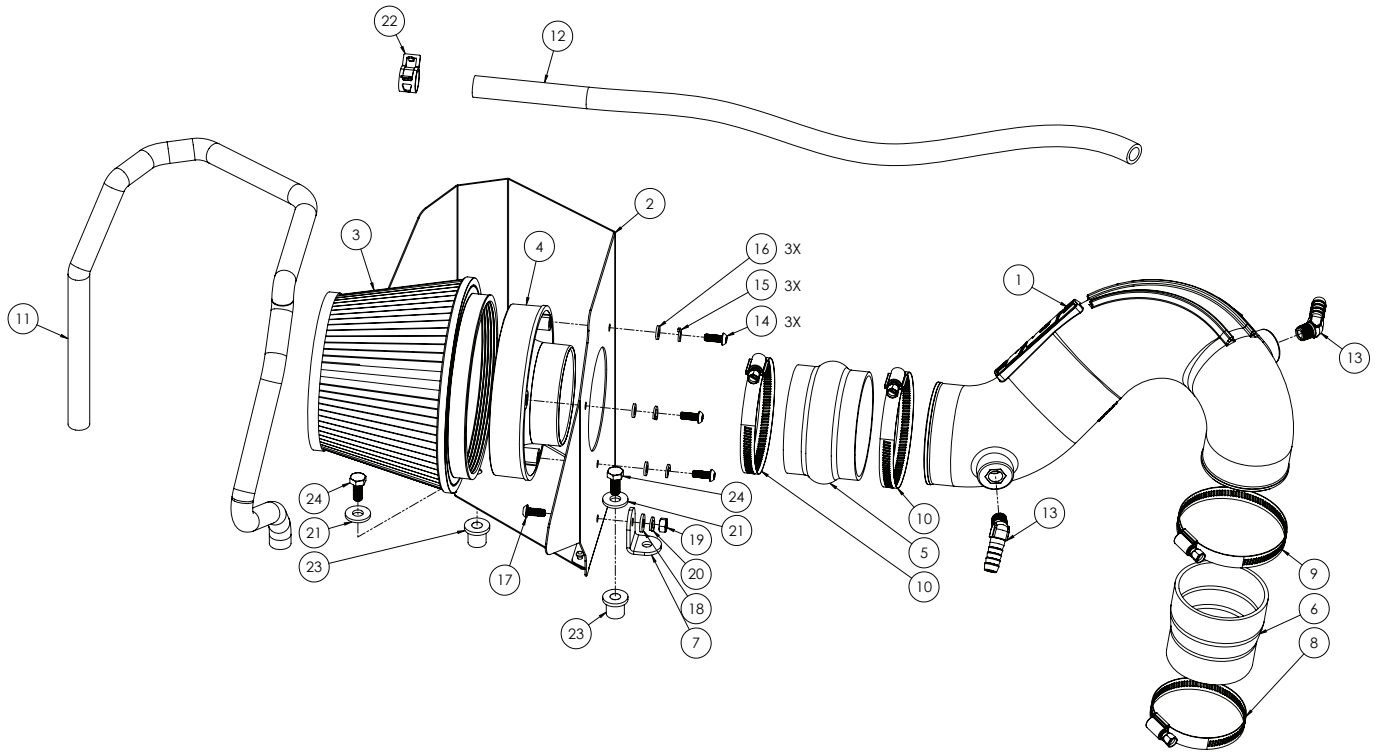

Installation Instructions
615211
 1991-95 JEEP WRANGLER YJ
 4.0L ENGINE



ITM #	PART #	DESCRIPTION	QTY.
1	AF2086	Molded Intake Tube	1
2	AF3083	Airbox	1
3	AF1012	Air Filter	1
4	AF6001	Air Filter Adapter	1
5	AF4019	Hump Rubber Coupler	1
6	AF4063	Rubber Coupler	1
7	AF5100	Bracket 1	1
8	MC250H	#44 Hose Clamp 2¼" - 3¼"	1
9	MC314H	#52 Hose Clamp 2¾" - 3¾"	1
10	MC350H	#56 Hose Clamp 3½" - 4"	2
11	49000061-42	Airbox Trim Seal- 42"	1
12	49000064-24	½" Fuel Hose- 24"	1

ITM #	PART #	DESCRIPTION	QTY.
N/A	PK1049	Hardware Package includes:	1
13	AF4029	½" Barb to ¼" 45° NPT Male	2
14	HW244	M6 x 1.0 x 16mm Screw	3
15	HW318	M6 Split Lock Washer	3
16	HW319	M6 Flat Washer	3
17	HW245	¼"-20 x ⅝" Screw	1
18	HW320	¼" Flat Washer	1
19	HW115	¼-20 Hex Nut	1
20	HW322	¼" Split Lock Washer	1
21	3401562	⅝" Flat Washer	2
22	MC003P	½" Hose Pinch Clamp	1
23	HW108	⅝" X 18 Well Nut	2
24	3401561	⅝"-18 X ¾" Screw	2

OVERVIEW:



1. Please take a moment to read and understand these instructions before installing your Flowmaster performance system.

NOTE: Please inventory all parts before starting the installation process and call our tech line to report any missing parts. This will help avoid potentially stranding your vehicle until any missing replacement parts arrive.

WARNING:

Avoid serious burns! Allow vehicle time to cool completely before handling any engine components.

REMOVE STOCK COMPONENTS:



2. Open hood then disconnect EVAP canister and PCV hoses from airbox cover.

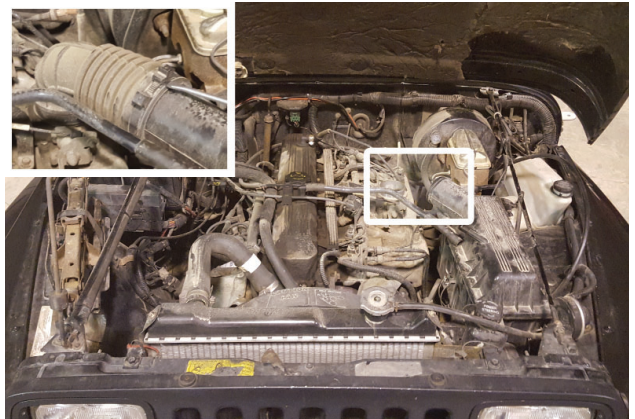

3. Loosen (x2) clamps and remove factory intake tube from vehicle.

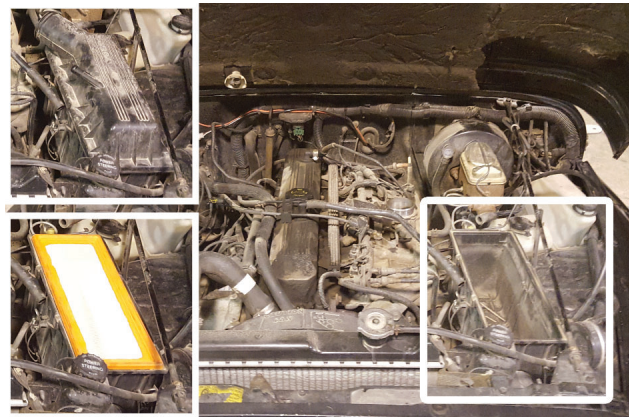

4. Unlatch then remove airbox cover and filter.

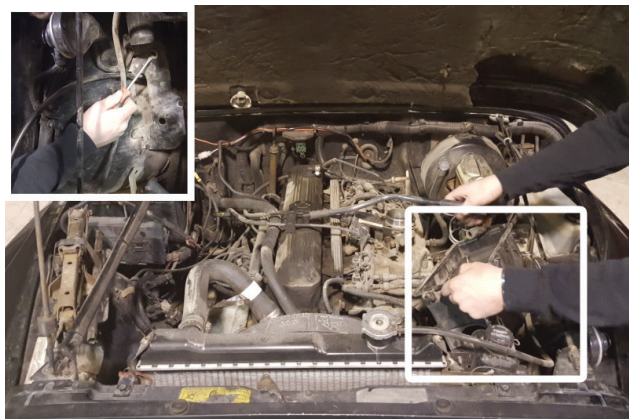

5. Remove airbox from vehicle then remove grommets from holes in base as shown.

ASSEMBLE AND INSTALL FLOWMASTER PERFORMANCE AIR INTAKE SYSTEM:



6. Starting at corner indicated, press **airbox gasket (11)** gradually around edge of **airbox (2)** then trim to fit as shown.

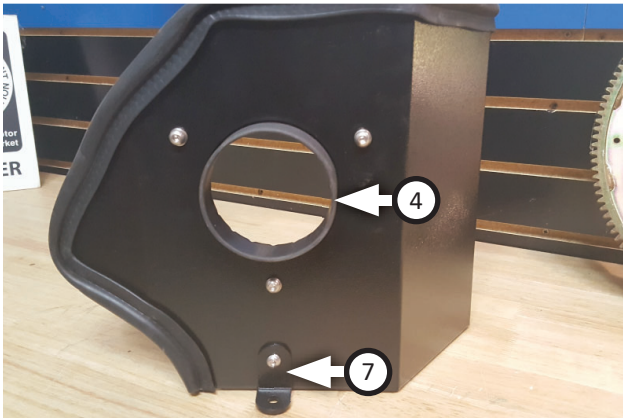

7. Install **bracket (7)** with **screw (17)**, **flat washer (18)**, **split lock washer (20)** and **nut (19)**. Install **adapter (4)** with (x3 ea.) **screws (14)**, **split lock washers (15)** and **flat washers (16)**.

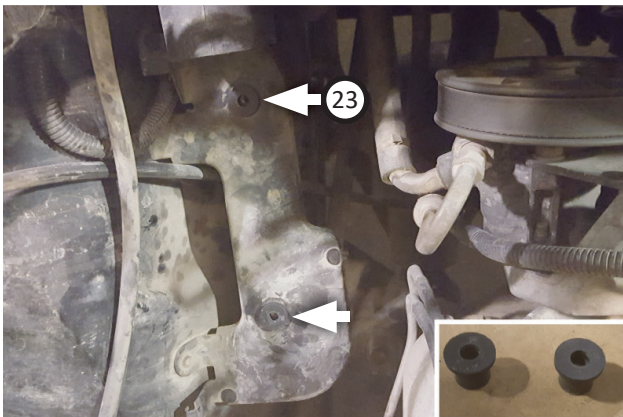

8. Install (x2) **well nuts (23)** into airbox mount in engine compartment.

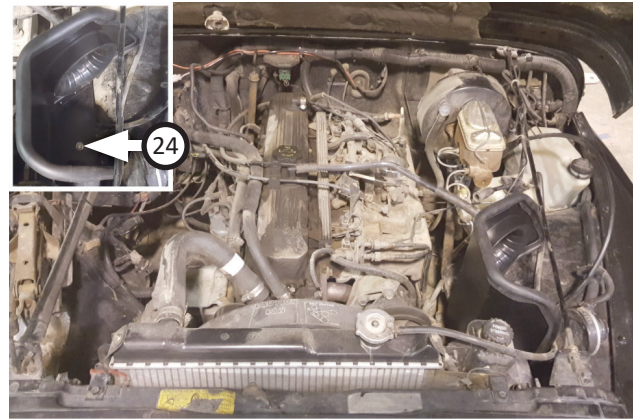

9. Install airbox into engine compartment, securing it with (x2 ea.) **screws (24)** and **flat washers (21)** into well nuts.

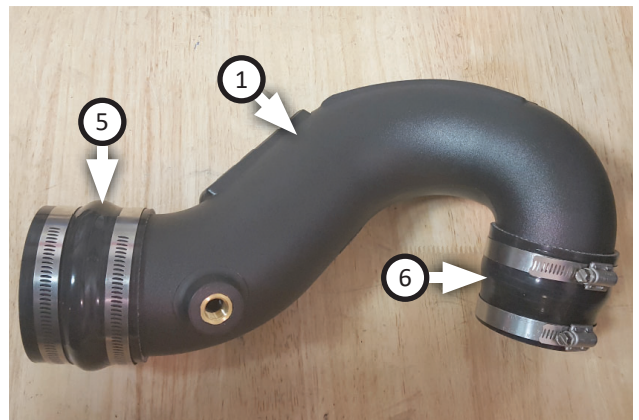

10. Place **couplers (5,6)** and **hose clamps (8,9,10)** onto **intake tube (1)**, referencing diagram as necessary. Tighten clamps enough to hold parts.

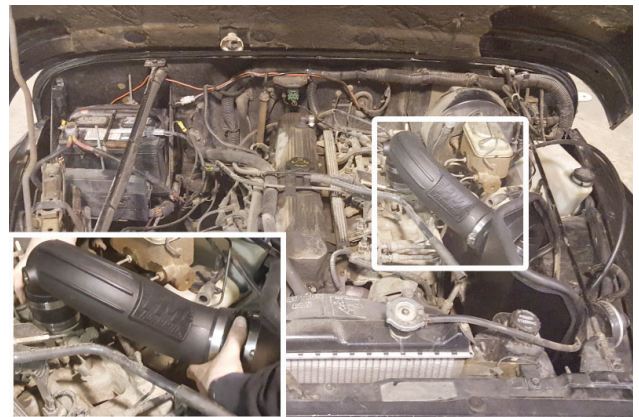

11. Place intake assembly onto throttle body and adapter in engine compartment. Press couplers against stops then center tube. Tighten screw clamps completely.

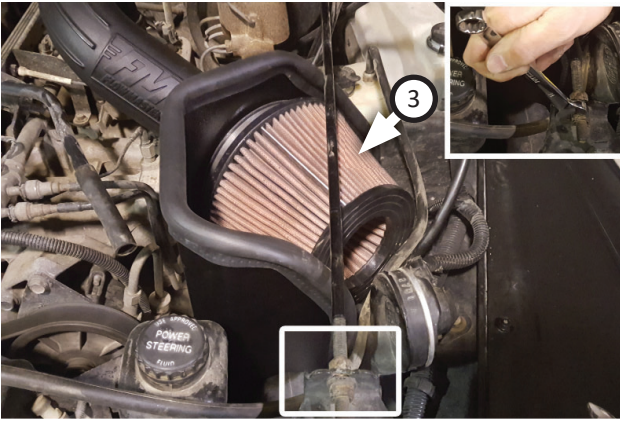

12. Loosen grill support rod nut to allow room for install. Set **air filter (3)** over air filter adapter in airbox, tighten screw clamp at its base then reinstall rod and nut.



15. Re-connect EVAP hose to barb, seating it firmly as shown.

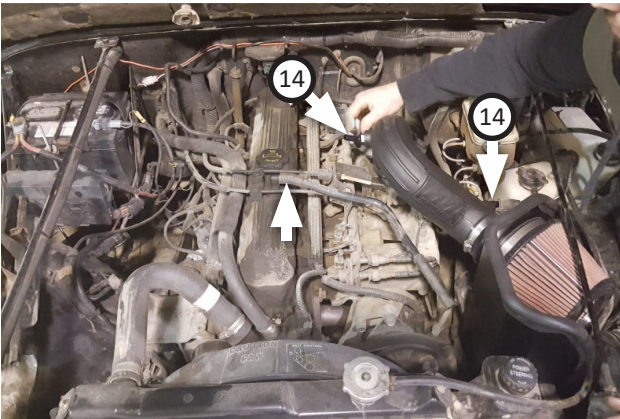

13. Disconnect and remove factory PCV hose from engine. Apply PTFE tape to (x2) **male barbs (14)** then install them into intake tube.



Congratulations, the installation of your Flowmaster Performance Intake system is now complete!

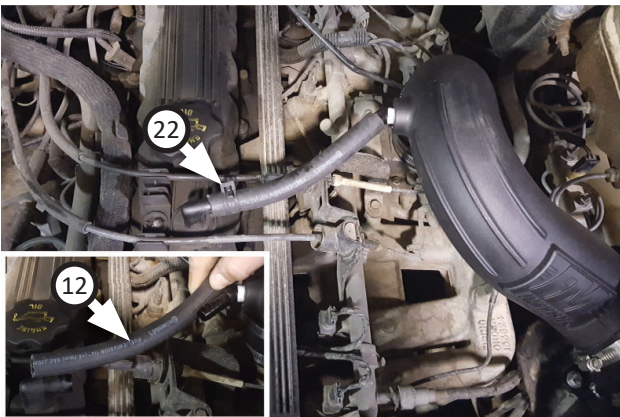

14. Trim to fit **fuel hose (12)** then connect it between barbs shown, fastening it with **hose pinch clamp (22)**.

