

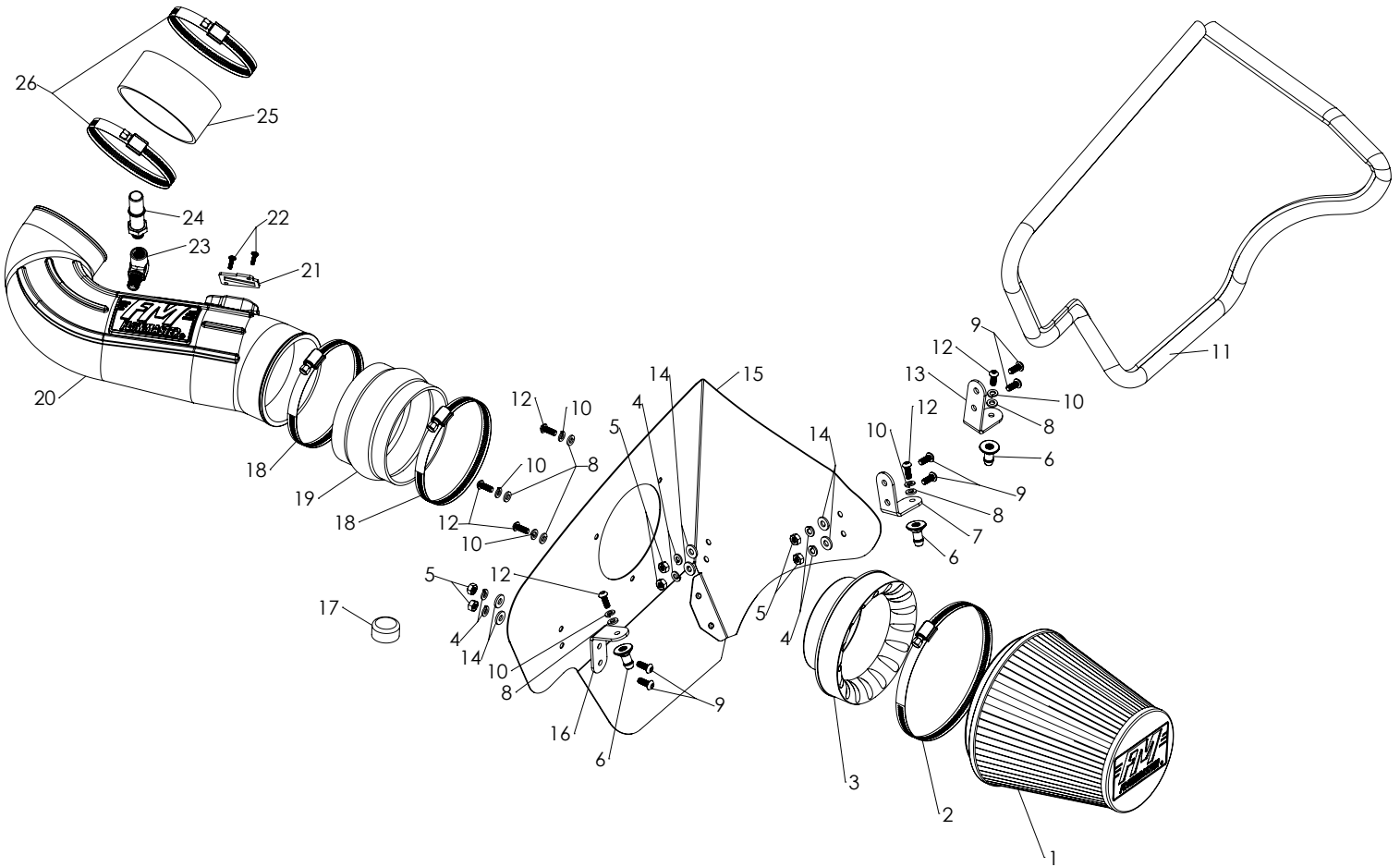

# Installation Instructions for: SYSTEM #615102

2016-2017 CAMARO  
6.2L Engine



ITEM NO.	PART NUMBER	DESCRIPTION	QTY.
1		FILTER, AIR 7.5" HIGH, 6" DIA. FLANGE	1
2	AF1002	#104 HOSE CLAMP 4.125 TO 7" DIA.	1
3	AF6003	4.50" TO 6.00" AIR FILTER ADAPTER	1
4	HW322	1/4" SPLIT LOCK WASHER SS	6
5	HW115	1/4"-20 NUT SS	6
6	AF7001	M6 X 1.0 BARB INSERT	3
7	AF5012	11 Ga. X 1" BRACKET #2, 16-17 CAMARO SS 6.2L	1
8	HW319	M6 FLAT WASHER SS	6
9	HW245	1/4"-20 X 5/8" BTNHD SS	6
10	HW318	M6 SPLIT LOCK WASHER SS	6
11	49000061	PUSH ON VINYL AIR BOX TRIM SEAL	1
12	HW244	M6 X 1.0 X 16MM BTNHD SS	6
13	AF5013	11 Ga. X 1" BRACKET #3, 16-17 CAMARO SS 6.2L	1

ITEM NO.	PART NUMBER	DESCRIPTION	QTY.
14	HW320	1/4" FLAT WASHER SAE SS	6
15	AF3004	16-17 CAMARO SS INTAKE AIRBOX	1
16	AF5011	11 Ga. X 1" BRACKET #1, 16-17 CAMARO SS 6.2L	1
17	AF4023	1.125 ROUND PLASTIC CAP	1
18	MC450H	#72 HOSE CLAMP 3 TO 5" DIA.	2
19	AF4021	4.5"ID X 3"L RUBBER COUPLER, HUMP	1
20	AF2004	16-17, CAMARO, 6.2L INTAKE TUBE	1
21	GA139	MAF SENSOR GASKET	1
22	HW248	M4 X 0.7 X 12MM RH PHILLIPS SCREW SS	2
23	AF4053	1/4" NPT MALE TO 1/4" NPT FEMALE, 90 DEG	1
24	AF4016	5/8" QUICK CONNECT TO 1/4" NPT MALE, STRAIGHT	1
25	AF4004	4.0" X 2"L RUBBER COUPLER, STRAIGHT	1
26	MC400H	#64 HOSE CLAMP 3 9/16 TO 4.5" DIA.	2

## VERIFY KIT CONTENTS:



1. Before starting , use the parts drawing and list (front page) to verify the kit's contents. In the unlikely event that any parts are missing, please contact FLOWMASTER Technical Support (see number below) for replacements.

To simplify assembly and eliminate the chance of cross-threaded fasteners , identify and separate the six ¼-20 screws (Item 9) (used with nuts (5)) , and the six M6 screws (12) (no nuts).

## REMOVE FACTORY AIR INTAKE SYSTEM:

NOTE: Please refer to vehicle manufacturer's recommendations regarding removal of factory components.

2. Turn off the vehicle's ignition and disconnect the negative battery cable.

NOTE: Disconnecting the negative battery cable erases pre-programmed electronic memories. Write down all memory settings before disconnecting the negative battery cable. Some radios will require an anti-theft code to be entered after the battery is reconnected. The anti-theft code is typically supplied with your owner's manual. In the event your vehicle's anti-theft code cannot be recovered, contact an authorized dealership to obtain your vehicle's anti-theft code.



3. Carefully remove the mass airflow (MAF) sensor lead by depressing the rocking tab on the back of the connector, then pulling straight off.

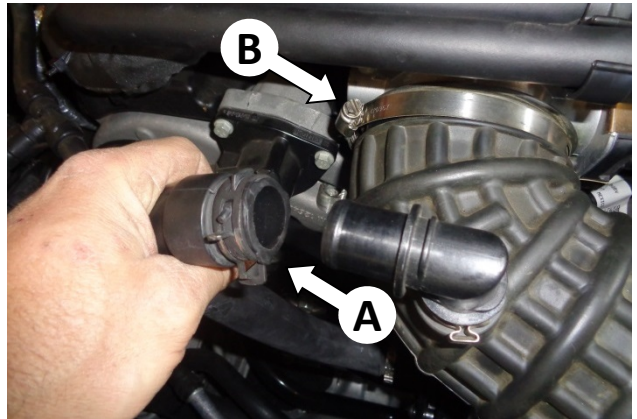

4. Use pliers to open the pinch clamp, and remove the resonator hose (A) from the intake tube. Then loosen the hose clamp (B) securing the intake tube to the throttle body.

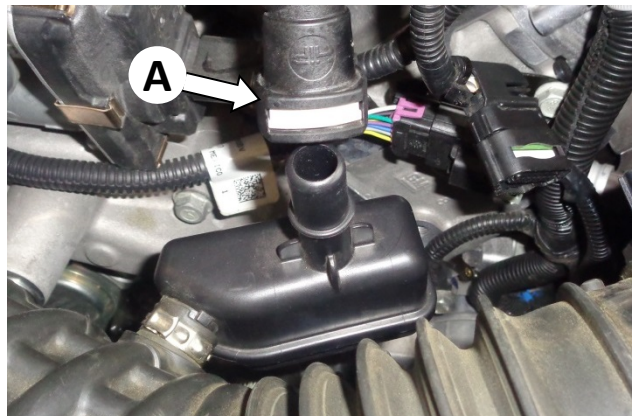

5. Disconnect the positive crankcase ventilation (PCV) tube (A) by depressing the release latch and pulling straight off. Let the hose hang in place for later reattachment.





6. Remove the intake tube from the throttle body.

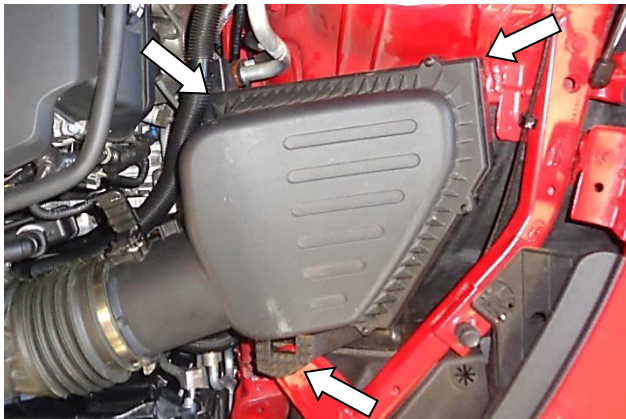

7. Grasp each corner of the airbox – one at a time – and firmly pull straight off to release each mount pin from its rubber grommet. After releasing all three pins, remove the airbox and intake tube.



8. Disconnect the back end of the resonator hose.

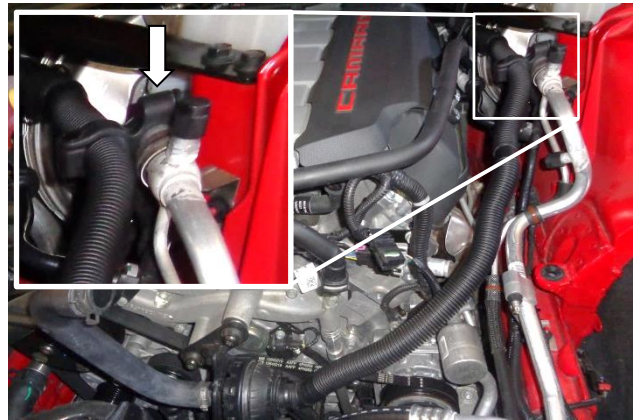

9. Disconnect the resonator hose clamp from the refrigerant line.

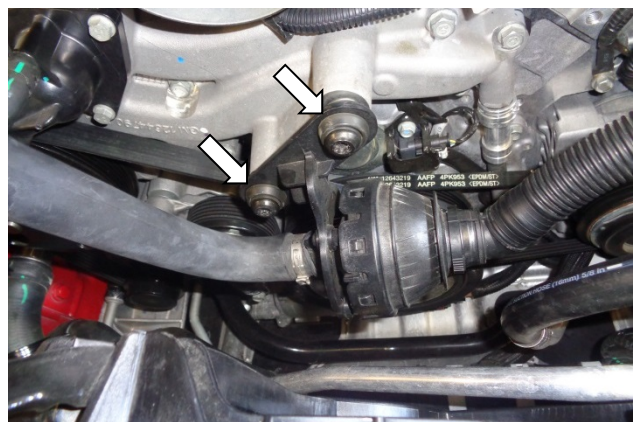

10. Remove the resonator's 2 mount screws, and remove the resonator and hoses from the vehicle.



11. Remove the MAF sensor from the intake tube, then remove the stock gasket from the sensor.  
**CAUTION: The sensor is delicate!** Handle it with care, and store it in a safe location until reinstallation.  
**NOTE: We highly recommend that you retain all factory air intake system parts.**



**ASSEMBLE AND INSTALL YOUR FLOWMASTER COLD AIR INTAKE SYSTEM:**

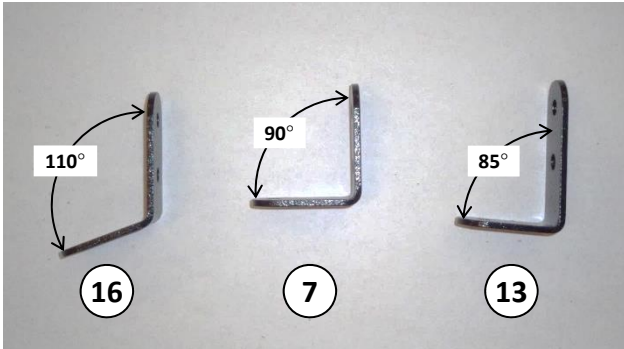

12. Identify airbox brackets (16), (7) and (13) by their bend angles, as shown above.



13. Attach brackets to airbox (15) at the locations shown, using ¼" screws (9) (on the bracket side), and flat washers (14), lock washers (4) and nuts (5) (on the airbox side). **NOTE: Orient tab on bracket (16) upward.**



14. At each bracket, install barbed pin (6), using M6 screw (12), lock washer (10) and flat washer (8).



15. Attach air filter adapter (3) to airbox using M6 screws (12), lock washers (10) and flat washers (8).

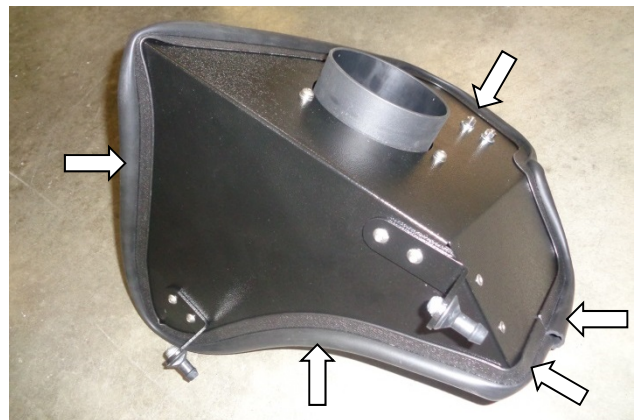

16. Attach rubber trim seal (11) to airbox . Starting at center of bottom edge of airbox, press the seal fully onto edge of airbox, working around the airbox. When you come back to the starting point, trim the seal to fit using metal shears.

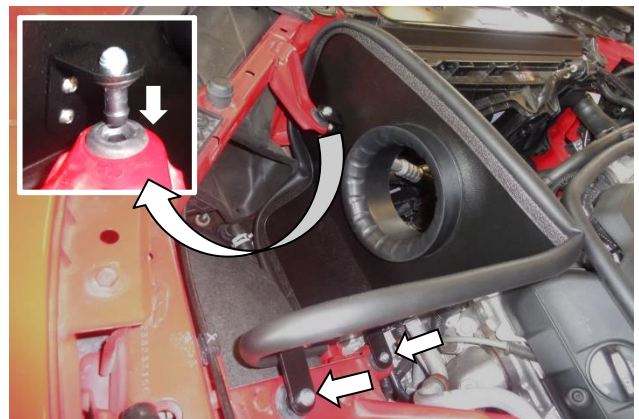

17. Install the assembled airbox in the vehicle by aligning the 3 barbed pins with their rubber grommets. Push each pin into its grommet, one at a time. (If necessary, moisten the grommets with soapy water to ease insertion.)



18. Apply 2 wraps of nylon thread tape to threads of PCV elbow (23), and install elbow into intake tube (20).



19. Apply 2 wraps of nylon thread tape to threads of straight PCV fitting (24), and install elbow into PCV elbow.



20. Install MAF sensor gasket (21) onto the sensor, ensuring correct orientation. Then install sensor in intake tube, using M4 screws (22).



21. Install 2 hose clamps (18) on flex (or humped) coupler (19), then install coupler on intake end of intake tube. Orient clamp screws upward to allow tightening after installation on vehicle.

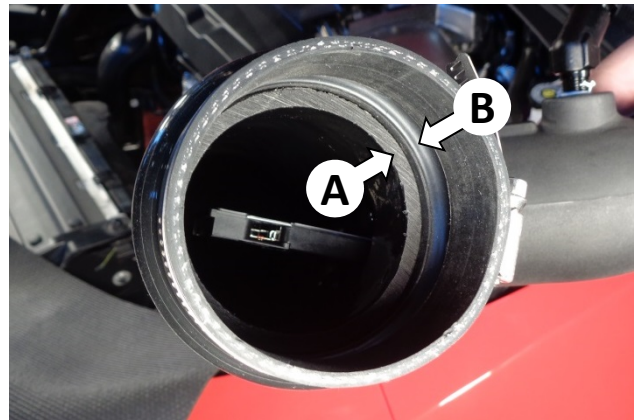

22. To allow proper flexing of the coupler during engine torquing, verify that the end of the intake tube (A) sits behind the coupler's transition lip (B).



23. Install 2 clamps (26) on straight coupler (25), then install coupler on discharge end of intake tube. Orient clamp screws upward to allow tightening after installation on vehicle.





24. Install assembled intake tube in vehicle and tighten all hose clamps.



25. Install PCV hose on fitting and check for security.



26. Install MAF sensor connector and check for security.



27. Install clamp (2) on air filter (1), install filter on filter adapter and tighten clamp.

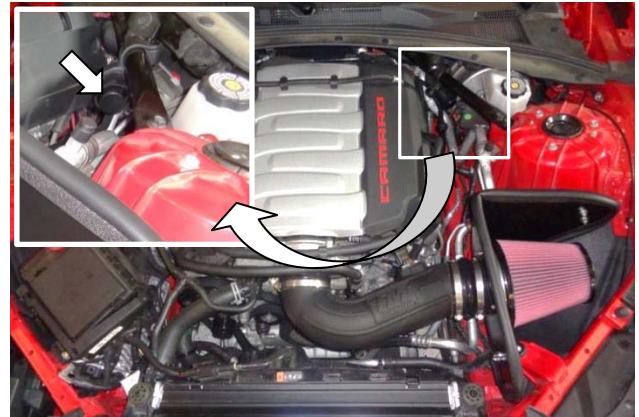

28. Install dust cap (17) on open end of resonator hose.

**Congratulations, the installation of your FLOWMASTER cold air intake kit is now complete!**