



**PERFORMER RPM MANIFOLD
CATALOG #7181
MODEL: Ford 351-W V8
INSTRUCTIONS**

- **PLEASE** study these instructions, and the General Instructions, carefully before installing your new manifold. If you have any questions or problems, do not hesitate to call our Technical Hotline at: 800-416-8628.
- **EGR SYSTEM:** This manifold will not accept stock EGR (exhaust gas recirculation) equipment . EGR systems are used on some 1972 and later model vehicles and only in some states. Check local laws for requirements.
- **MANIFOLD:** The Edelbrock Performer RPM manifold has been designed for 351-W Ford V8 engines equipped with the following cylinder heads: OEM 12 or 16-bolt, AR/Ford aluminum M-6049-J302, Ford GT-40 cast iron M-6049-L302, Dart cast iron, TFS/Street Heat aluminum or equivalent. The manifold accepts late model water neck, air conditioning, alternator and ignition systems. Use the recommended electric or manual type choke carburetors only. This manifold is recommended for street high performance and race vehicles only. It provides horsepower and torque increases from 1500 rpm to 6500 rpm when used with the matching Performer RPM components and other aftermarket equipment designed to operate within that range.
- **ACCESSORIES & INSTALLATION ITEMS:** Major recommendations are listed below. However, due to the variety of years, makes and models to be covered, please review each part listed in the Installation Items section of the Edelbrock catalog to decide whether more items are required for your specific vehicle than are mentioned in these instructions.
- **POWER PACKAGE:** Edelbrock Performer manifolds are part of a Total Power Package System that can be completed with the use of dyno-matched Performer RPM camshaft #7182, valve springs #5722, Performer-Link chain set #7870 or Accu-Drive gear drive #7892, Edelbrock Performer series carburetors and related parts specifically designed to give you maximum results.

- **CARBURETOR RECOMMENDATIONS: CAUTION:** Use only carburetor recommended. If parts required for installation are unavailable locally, contact Edelbrock directly.

CARBURETOR	REFERENCE	PARTS REQUIRED FOR INSTALLATION
Performer #1407 (750 cfm)	A, I, K, N, O	Throttle lever kit #1483, Throttle plate kit #1490 for automatic transmission and cruise control #8011 if necessary

A-Carburetor will work with non-EGR (Exhaust Gas Recirculation) or pre-emission control system
 I-Carburetor has no provision for evaporative canister
 K-Carburetor requires #8008 or #8024 stud, nut and washer kit. Determine length needed before installation
 N-Carburetor will accept factory cruise control
 O-Carburetor has manual choke only
 If electric choke is required use Edelbrock kit #1478
 Installation Notes: Manifold has been tested and proved compatible with Holley 0-4779 (750 cfm)
 Manifold height: A-4.3", B-5.3"

- **CAUTION:** Manifold will not fit under stock hood of 1974 to '78 or 1979 to '91 Mustangs.

• **GASKETS AND SEALANT**

CAUTION: Do not use high performance or competition type intake gaskets for street application. Due to material deterioration under street driving conditions, internal leakage of both vacuum and oil may occur.

1. Use only #7221 Edelbrock gasket set or OE equivalent when installing Edelbrock manifolds for street applications with 16-bolt heads. 12-bolt heads use OE specification 12-bolt gaskets.
2. Apply Edelbrock Gasegacinch sealant, #9300, to both sides of the manifold as well as head surfaces. This procedure ensures a good seal.
3. Eliminate the end seals. Use RTV silicone sealer instead. Apply a bead of sealant approximately 1/4" high across the block end seal surface, overlapping the intake gasket at the four corners. This method eliminates end seal slippage and deterioration.
4. For ease of installation, we recommend using Edelbrock Manifold Bolt & Washer Kit, #8584.

- **MANIFOLD TORQUE**

1. On early model heads, there is no support underneath manifold bolts circled 5,6,7, and 8. You will need to hand tighten these bolts being careful not to damage the manifold. Torque all other manifold bolts circled in Figure 1 to 25 ft/lbs. See Figure 1 for proper sequence.

- **BRACKETS**

The Performer RPM manifold is supplied with two sets of throttle bracket mounting holes to adapt both early and later type throttle brackets to our manifold.

- **SPECIAL INSTRUCTIONS**

On some applications when using a Performer carburetor, there may be an interference problem with the stock air cleaner. If this problem occurs, use the Edelbrock adapter #8092 or Pro-Flo air cleaner #1221. CAUTION: Check for clearance before closing hood when using this spacer or air cleaner.

- **KIT CONTENTS**

- 1- Performer RPM manifold
- 1- Set of Installation Instructions

- **FIRING ORDER AND CYLINDER NUMBERING**

1. For cylinder numbering and firing order, see Figure 2.

- **FINAL TUNING FOR OPTIMUM PERFORMANCE**

NOTE: Local emission laws must be checked for legality of any carburetor or ignition changes.

1. Due to design, the fuel / air mixture and cylinder charging are very efficient with the Performer RPM manifold. Generally speaking, the stock jetting for the Performer Series carburetor will not need changing. Specific applications may show an increase in power by richening the secondary jetting .003 from the stock setting (from 0.107" to 0.110").
2. Aftermarket distributor curve kits may be used with Performer RPM manifolds.
3. Use modified or high performance cylinder heads, and port-match the manifold to the heads.
4. The compression ratio should be at least 9.5 to 1.
5. Installation of aftermarket headers, camshafts or both with an Edelbrock Performer RPM manifold may lean carburetor calibration. Should this condition occur, re-calibrate with a richer jet.

- **CAMSHAFT AND HEADERS**

The Performer RPM manifold is compatible with aftermarket camshafts and/or headers. Edelbrock has developed a dyno-matched, street proven camshaft, the #7182 which is suitable for use with the Performer RPM #7181. This camshaft will require the use of adjustable high performance rocker arms, studs, retainers, and Edelbrock Sure-Seat valve springs #5722.

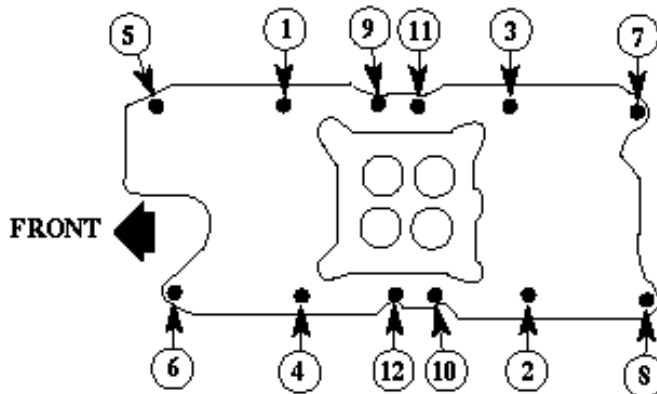

Figure 1
Intake Manifold Tightening
Sequence

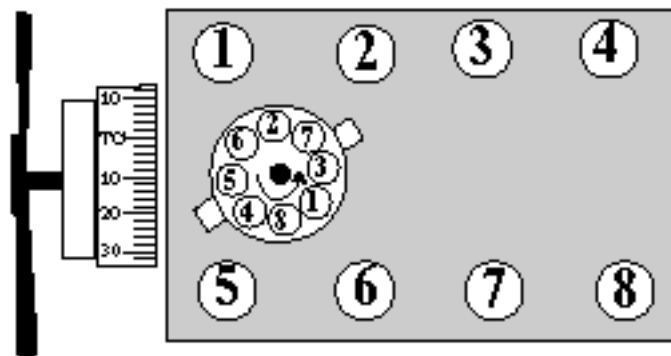

Figure 2
Ford 351-W V8 Firing
Order 1-3-7-2-6-5-4-8
Turn Distributor
Clockwise to Advance
Timing

•PLEASE complete and mail your warranty card. Be sure to write the model number of this product in the "Part #____" space.

THANK YOU



GENERAL INSTRUCTIONS FOR INTAKE MANIFOLD REMOVAL AND INSTALLATION

The following instructions must be carefully studied and understood before you remove your stock manifold. Failure to follow these instructions may void the warranty.

NOTE: Included with your Edelbrock manifold package is a separate manifold instruction sheet. That instruction sheet lists carburetor selection, installation parts, modifications (if needed), and all technical specifications. This must be read carefully. If you have any questions please contact Edelbrock direct . See page #8.

CAUTION: Improper installation will result in:

Low Mileage

Poor Performance

Costly Re-Installation

To avoid these problems, you must use the preliminary checklist printed below for your convenience.

PRELIMINARY CHECK LIST:

- Carefully study and understand ALL instruction sheets.
- Carefully check the manifold instruction sheet to make sure it is the correct one.
- Inspect manifold for possible shipping damage (if damaged, contact your dealer immediately).
- Check all threaded holes.
- Check all internal passages with a light and a wire making sure they are clean and unobstructed.
- Use correct Edelbrock or OEM gaskets with Edelbrock Gasgacinch #9300 and RTV silicone sealant.
- Use Teflon tape or PST thread sealer on all pipe plugs, fittings and bolt threads.
- Remove dowel pins from end seal surface on Ford and Chrysler products. Use grip pliers for removal.
- Use correct carburetor and adapter if recommended. Always use a new carburetor base gasket.
- Re-install vacuum lines correctly and replace all bad lines with the correct size.
- Position manifold and follow torque sequence correctly as per instruction sheet.
- Set ignition timing to correct specification.
- Check carburetor, points, plugs, wires and distributor vacuum and mechanical advance systems to avoid possible problems in the future.
- Check automatic transmission shift points before removal of your stock manifold, and adjust linkage after Edelbrock manifold installation for same shift points (if needed).
- Check air/fuel ratio before and after new manifold installation.
- Check emission parts for proper function before removing stock manifold.
- Adjust the automatic choke correctly.

NOTE: We recommend that you refer to this checklist again AFTER installation to be sure you have completed all steps.

EDELROCK WARRANTY

It is the constant endeavor of the Edelbrock Corporation to give our customers the highest quality of performance products obtainable. Edelbrock warrants each new product to be free from defects in both workmanship and materials to a period of one year from date of purchase, provided that the product is properly installed and subjected to normal use and service and that the product is not modified or altered in any way unless specified by our instructions. Customers requiring warranty assistance should contact the dealer from whom they purchased the product. In turn, the dealer will contact Edelbrock, and we will determine the method of satisfying the warranty.

Should Edelbrock determine that the product be returned to the factory, it should be accompanied by proof of purchase and a clear notation of the exact problem encountered. The product must be returned freight pre-paid. If a thorough inspection of the product by the factory indicates defects in workmanship or material, our sole obligation shall be to repair or replace the product. This warranty covers only the product itself and not the cost of installation or removal.

EDELROCK CORPORATION SHALL NOT BE LIABLE FOR ANY AND ALL CONSEQUENTIAL DAMAGES OCCASIONED BY THE BREACH OF ANY WRITTEN OR IMPLIED WARRANTY PERTAINING TO THIS SALE, IN EXCESS OF THE PURCHASE PRICE OF THE PRODUCT SOLD.

THINGS TO DO BEFORE YOU REMOVE THE STOCK MANIFOLD

TOOLS AND EQUIPMENT:

Use the following checklist for items needed:

- Box and open end wrenches
- Socket set
- Distributor wrench
- Pliers (channel locks and hose clamp)
- Screw drivers (regular and Phillips)
- Torque wrench
- Hammer
- Gasket scraper or putty knife
- Timing light
- Vacuum gauge
- Rags
- Water bucket

SHOPPING LIST:

- Gaskets-Edelbrock, OEM or OEM equivalent
- Pipe plugs, if needed
- Edelbrock Gasgacinch (#9300)
- RTV High Temp silicone sealer or O/2 sensor safe
- Masking tape
- Modeling clay or putty
- Chalk
- Paper and pencil
- Radiator coolant
- Vacuum gauge
- Teflon thread tape or PST thread sealer or equivalent
- Check manifold instruction sheet for catalog numbers of Edelbrock or OEM parts needed for your installation.

CHECKING HOOD CLEARANCE:

NOTE: Check hood clearance BEFORE removing stock manifold.

1. Use modeling clay or putty and make five stools, two or three inches high.
2. Position stools on air cleaner at front, rear, each side and on center stud. See Figure 1.
3. Close hood to locked position and re-open.

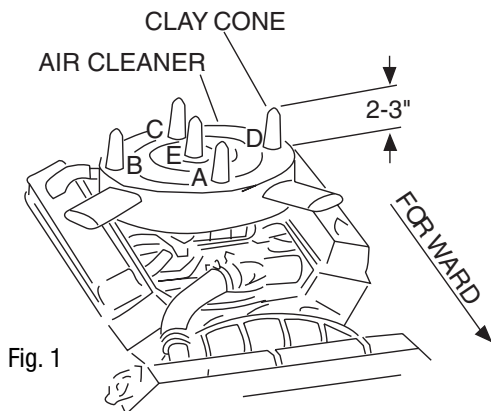

Fig. 1

4. See Figure 2 and record measurements in blank spaces labeled A-B-C-D-E.
5. These figures show the amount of clearance between the hood and the air cleaner.

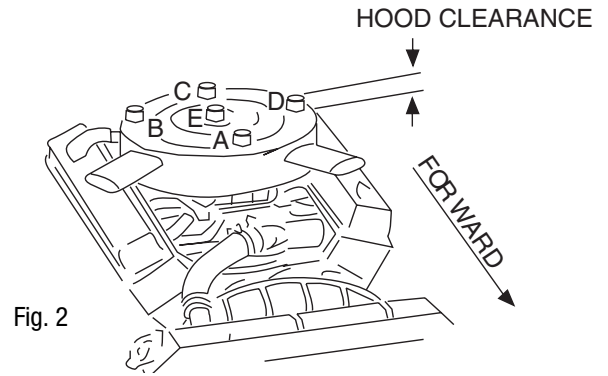

Fig. 2

MANIFOLD AND CARBURETOR HEIGHT:

1. Remove the air cleaner.
2. Lay a straightedge (such as a yardstick) across top of carburetor from front to back.
3. Measure from block and manifold end seal surface. See Figure 3.
4. Record measurements in blank spaces labeled OM1 and OM2.
5. Measure height of carburetor and record in space C3.

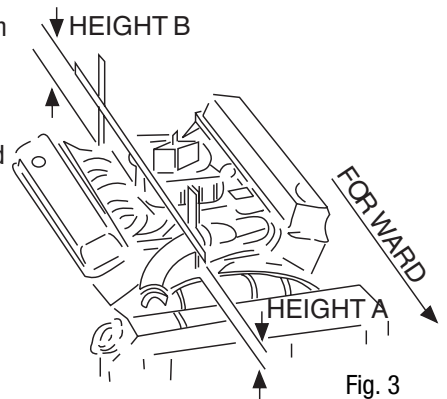

Fig. 3

NOTE: Most 4-bbl carburetors are about 3-1/4" tall (mounting flange to air cleaner flange).

6. Place straightedge on top of new manifold including any adapters or gaskets you plan to use.
7. Measure distance from end seal surface as you did on stock manifold. See Figure 4.
8. Record measurements in spaces NM1 and NM2.
9. Add carburetor measurement C3 to new manifold figures you recorded.
10. If the new combination is taller, subtract this amount from the hood clearance figure for the new hood clearance.

CAUTION: You must maintain at least 1/2" clearance between the hood and air cleaner because of engine torque. If you have insufficient clearance, a low profile air cleaner may solve the problem.

NOTE: On engines without end seal surfaces, select a standard point from which to measure.

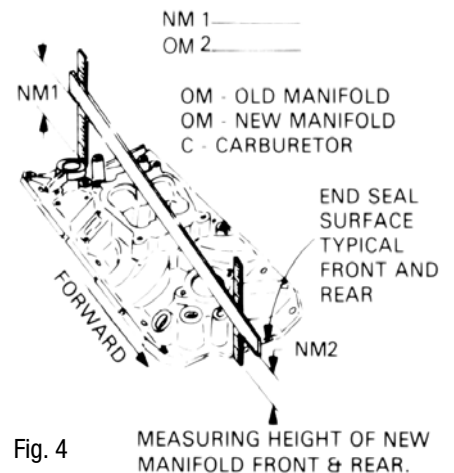

Fig. 4

AIR CLEANER:

Use stock air cleaners unless changing carburetor.

NOTE: If a new or replacement air cleaner is used, there may be inadequate hood clearance. Make sure it performs the same function as stock and meets legal emissions requirements.

AUTOMATIC TRANSMISSION CHECK:

1. To assure best performance, economy and emissions, the shift point **MUST** be checked before and after the manifold change. We suggest this method. From a standing start in drive, **PUSH THE THROTTLE WIDE OPEN**. Hold in this position. Note speedometer M.P.H. when it makes the first shift. After new manifold installation, make the same test noting M.P.H. of the first shift.
2. If adjustment is necessary and to avoid possible transmission damage, refer to manifold instruction sheet, your local dealer, a transmission shop, or automotive repair manual for the correct adjustment procedure.

CHECKING EMISSION LEVELS:

1. Where required by law, after making any equipment change to the engine package, it is the responsibility of the consumer to make certain all OEM emission equipment remains operational.
2. Edelbrock recommends that tailpipe levels be measured before and after equipment installation. This procedure will provide guidelines for keeping vehicle emission levels within legal limits.
3. Edelbrock cannot be responsible for vehicle emissions if all such devices are not re-connected.

NOTE: If any emission part cannot be re-installed with your Edelbrock manifold, contact: Edelbrock Corporation.

EGR SYSTEMS:

Exhaust Gas Recirculation (EGR) systems are used on some 1972 and later passenger cars, trucks and recreational vehicles. If your vehicle has an EGR system, law requires that you retain this system with your new Edelbrock manifold.

EXHAUST MANIFOLD HEAT RISER VALVE:

1. If your vehicle is equipped with an exhaust manifold heat riser valve (generally located on the passenger side of vehicle below the exhaust manifold), check the valve for proper operation.
2. This valve is spring-loaded and must work freely from the close to open position by hand.
3. After engine warm up, the bi-metal spring must keep the valve in the open position. If the valve does not open or opens only part way, excessive exhaust heat will transfer through intake manifold, causing damage to the manifold.

AUTOMATIC CHOKE:

1. With engine cold and not running, remove air cleaner and open throttle by hand. This will allow the choke blade to close.
2. By hand, feel how much tension is holding the blade closed. Preliminary setting should be the same **AFTER** manifold installation. See choke section on later pages.

BRACKETS:

You may require some bracket parts or bracket modification when replacing a 2-bbl carburetor with a 4-bbl carburetor. Refer to the manifold instruction sheet for Edelbrock and OEM part numbers needed and drawings of possible parts modification.

CLEAN ENGINE:

1. We recommend cleaning engine to prevent dirt from falling into engine lifter valley or intake ports.
2. Cover ignition system Use Gunk (or equivalent) and a brush to thoroughly clean manifold and the area between manifold and valve covers.
3. Rinse with water and blow dry.

VACUUM LINES:

1. Vacuum lines are a major source of manifold, carburetor, and ignition malfunction problems causing poor mileage, performance, and high emissions.

CAUTION: It is very critical that the procedure outlined below be followed and completed with extreme care.

2. Before removing stock manifold, you may either make a sketch or tag each vacuum line with masking tape showing where each line goes on the carburetor, manifold, distributor, transmission, all emission sensors and EGR valve.

NOTE: You are dealing with two types of vacuum signals. No. 1 is called Manifold Vacuum. No. 2 is called Timed Port Vacuum. Each has its particular function and must be connected correctly for proper engine, transmission, ignition, emission and accessory function. Use the following procedure to determine one from the other and note it on your sketch or tags.

MANIFOLD VACUUM CHECK:

1. Start the engine with vehicle out of gear, set the brake and block the wheels. Idle until engine is warm and the automatic choke is completely off.
2. With engine at idle, place a vacuum gauge or your finger over the end of each line and check for vacuum. If it shows vacuum, note on your sketch or tag as "manifold vacuum". As seen below.

TIMED PORT VACUUM CHECK:

1. For lines not showing vacuum in the previous test, open throttle slowly to about 1500 rpm. If you now show some vacuum, note on tags or sketch as "timed port vacuum".

CAUTION: Vacuum line fatigue is common. It is wise, at this time, to replace all vacuum lines, making sure you use the correct size.

NOTE: Remember all lines must be re-connected to their proper vacuum source.



REMOVING THE STOCK MANIFOLD:

1. Disconnect battery.
 2. For ease of installation, keep all parts in some sort of order.
- WARNING:** Do not remove manifold if engine is hot.
3. Drain radiator coolant (drain plug will normally be located on lower right facing engine).
- NOTE:** See individual manifold installation sheet for water draining requirement. Some engines do not require draining, such as Cadillac, 383-440 Chryslers, 351-C and 351-M Fords.
4. Remove gas cap to relieve pressure. Disconnect fuel line and plug. Replace gas cap.
 5. Disconnect all linkage from carburetor such as throttle, throttle springs, transmission, cruise control and automatic choke.
 6. Tag and remove coil wires and sensor wires.
 7. Remove previously marked vacuum lines.
 8. Remove radiator hose, thermostat housing and thermostat, if mounted on manifold.
 10. Remove all brackets that are on the manifold.
 11. Loosen or remove valve cover bolts on valve covers for manifold removal and replacement. It may be necessary to replace valve cover gaskets, if broken, to prevent oil leakage.

REMOVING IGNITION:

CAUTION: Follow instructions carefully, as serious damage can occur when ignition is not installed correctly.

1. Remove distributor cap.
2. Note position of rotor and make a mark on the distributor case in line with the rotor point.
3. Note position of distributor vacuum canister and place one type of mark on valve cover or firewall in line with the vacuum outlet.
4. Note position of points (or magnetic trigger wheel), if open, how much; if closed, note the distance from point block to cam lobe.
5. See Figure 5 for all details.
6. Remove distributor.
7. Do not rotate engine after removing distributor.

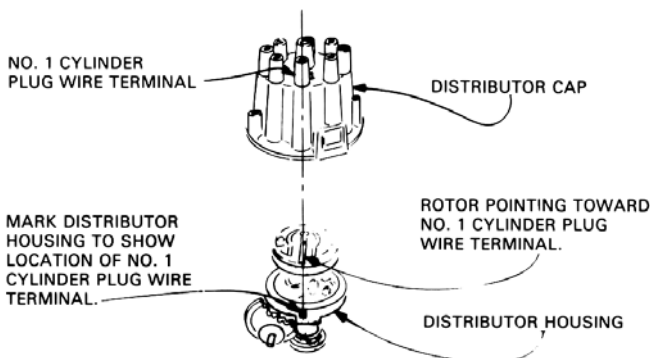

Figure 5

DOWEL PIN REMOVAL:

WARNING: On most Chrysler and Ford engines, there are dowel pins in the front and rear valley seal surfaces. These dowel pins **MUST** be removed. Edelbrock manifolds are not drilled for dowel pins and will not seal if they are not removed. Damage may result.

PREPARATION PROCEDURE FOR

INSTALLING YOUR EDELBROCK MANIFOLD PORT SURFACE CLEANING:

See Figure 6. To prevent gasket pieces from falling into ports and combustion chambers when cleaning old gaskets from head surfaces, lay rags in lifter galley and stuff paper or rags into ports. When clean, remove stuffing carefully making sure all particles fall on rags in lifter galley. Carefully remove rags containing particles. Wipe surfaces clean with rags using lacquer thinner to remove any oil or grease.

NOTE: This is a **MUST** to ensure proper sealing.

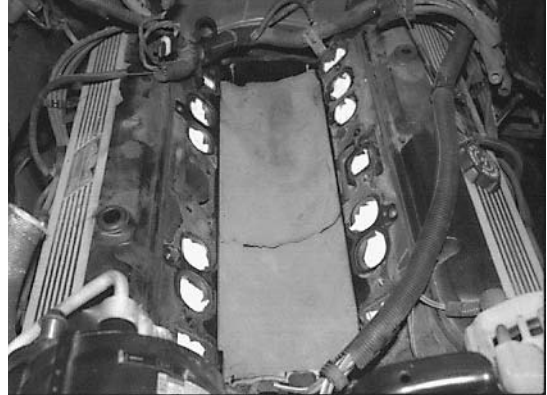

Figure 6

INSTALLING FITTINGS, PIPE PLUGS & STUDS:

1. Do not over-tighten or cross-thread fittings, pipe plugs, studs or bolts in your aluminum manifold. Damage to threads or a cracked mounting boss may result unless caution is used when installing accessories.
2. Use Teflon tape or PST thread sealer or equivalent. Install fittings, pipe plugs and carburetor studs from your stock manifold.

GASKET SURFACE PREPARATION:

CAUTION: Always use new gaskets as recommended. Check with gasket manufacturer for compatibility with aluminum intake manifolds. We recommend Fel-Pro Printoseal gaskets. The use of Permatorque gaskets can lead to improper sealing due to the hardness of the gasket. **Don't USE** Permatorque gaskets.

1. Check gaskets on head surface and manifold to make sure they are correct. Beaded side faces up.
- NOTE:** In some cases there may be a right and left side gasket difference. Be sure they are placed correctly.
2. Coat head surface and cylinder head side of intake gaskets with Edelbrock Gasgacinch #9300. See Figure 7.

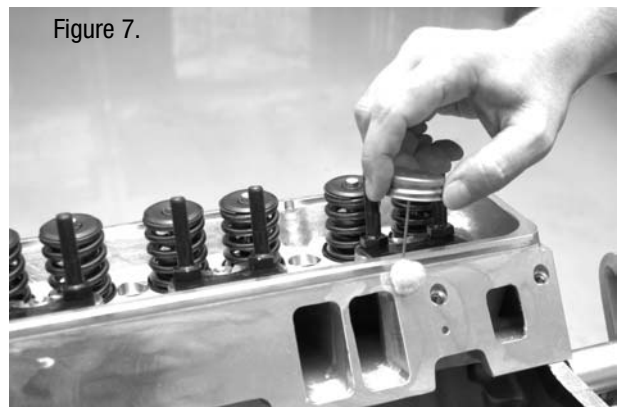
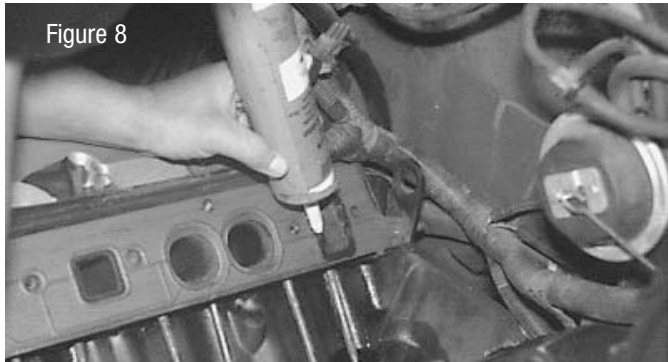
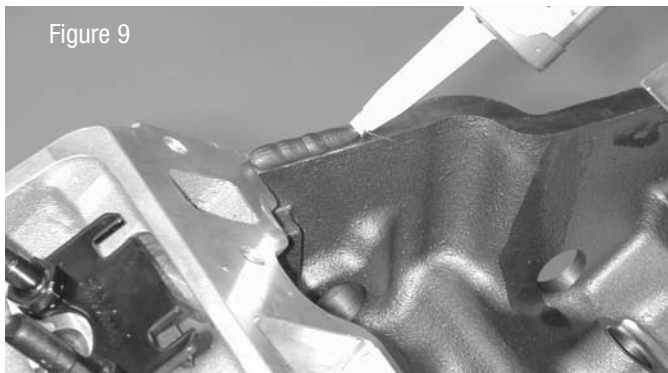

Figure 7.

3. Within a few minutes gaskets and surface will become tacky to the touch. Carefully place gaskets on head surface, aligning ports and bolt holes.
4. With Gasket in place apply a small amount of RTV High Temp silicone sealer around water passages intake manifold side. See Figure 8.



- 5.. With Edelbrock manifolds, you must use RTV High Temp silicone sealer instead of end seal gaskets. Apply a 1/4" thick ribbon of sealant across each end seal surface. Some installation require O2 sensor safe silicone See Figure 9.



MANIFOLD INSTALLATION:

1. Carefully position manifold on engine, centering bolt holes with bolt holes in head.
NOTE: On some Ford and Pontiac manifolds, study manifold instruction sheet for special instructions.
2. Refer to manifold instruction sheet for placement of any special bolts furnished with your manifold.
3. Apply RTV silicone or Teflon tape to bolt threads, where exposed to water, oil or engine vacuum..
4. Start all bolts by hand. Refer to individual manifold instructions for torque sequence.

CARBURETOR INSTALLATION:

CAUTION: Use only recommended carburetors listed on manifold instruction sheet. You **MUST** use a new base gasket. For non-OEM carburetor, install according to manufacturer's instructions. Use gaskets furnished with carburetor.

1. Connect all fuel lines, linkage and throttle springs.
2. Connect all vacuum lines. Refer to your drawing or tags for correct placement.

WIRING

Connect all electrical wiring as per drawings or tags.

THERMOSTAT:

1. To ensure proper function of your thermostat, place it in a pan of boiling water. It should open quickly to the wide open position. If questionable, replace it with one for the correct year and model of your vehicle.
2. Install thermostat with proper orientation. Apply Edelbrock RTV silicone on manifold surface using a new gasket and place it in position aligning holes. Apply RTV silicone to water neck surface and bolt threads. Position water neck. Start bolts by hand and tighten.
3. Make sure radiator drain is closed. Replace coolant.
4. Re-connect battery.

INSTALL IGNITION:

1. Manifold must be in place and torqued to specifications.
2. Install distributor with rotor pointing to your mark on the housing and the vacuum can lined up with your mark on the firewall or valve cover. See Figure 10.
3. Make sure the distributor is all the way down and ignition shaft is fully engaged in oil pump drive.
4. Rotate distributor until point opening or magnetic trigger wheel alignment is the same as when you removed the ignition.
5. Install hold down clamp and tighten to hold in place.
6. Final setting to specifications must be made with a timing light.

RE-TIMING ENGINE:

NOTE: If for some reason engine was rotated, the engine must be re-timed. Use the following procedure for re-timing the engine.

1. Remove spark plug from No. 1 cylinder. See individual manifold instruction sheet for No. 1 cylinder.
2. Remove coil wire from distributor and ground it.
3. **THIS STEP REQUIRES TWO PEOPLE OR A REMOTE STARTER SWITCH.** One person rotates engine by slowly bumping starter. One person holds his finger over the No. 1 plug hole until compression is felt.
4. Continue to bump starter until timing mark on the crankshaft pulley shows approximately 5 degrees before top dead center.
5. See Figure 10 for correct positioning of rotor and ignition on No. 1 cylinder.

Figure 10

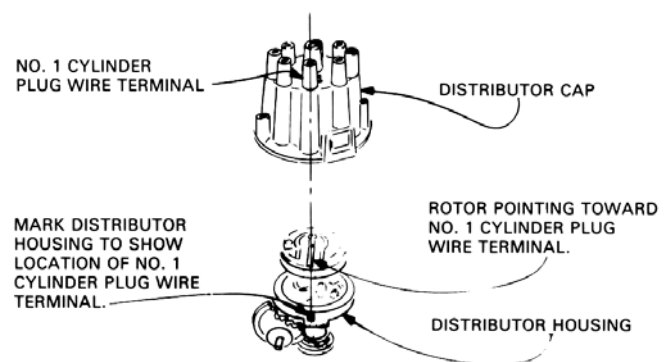

6. Disregard previous mark placed on distributor.
 7. Install distributor so that rotor lines up with new mark and points are just open or magnetic trigger wheel aligns with sensor.
 8. Final setting to factory specifications is made with a timing light.
- NOTE:** Rotate distributor opposite direction of rotor rotation to advance timing. Rotate with rotor rotation to retard timing. If these instructions are followed carefully, the engine should start and not backfire after the manifold installation.

AUTOMATIC CHOKE:

CAUTION: Improper or careless setting of the automatic choke will cause poor mileage and poor performance. Follow detailed instructions carefully.

STOCK ELECTRIC CHOKE:

1. When installing your OEM electric choke carburetor, re-connect choke wire as removed. **DO NOT USE COIL WIRE**
 2. When replacing OEM electric choke carburetor with an Edelbrock electric choke carburetor, connect the choke wire to the choke cap terminal marked "+". In some cases the wiper or heater motor .
- NOTE:** Be sure the other connector is connected to a good ground. See Figure 11.

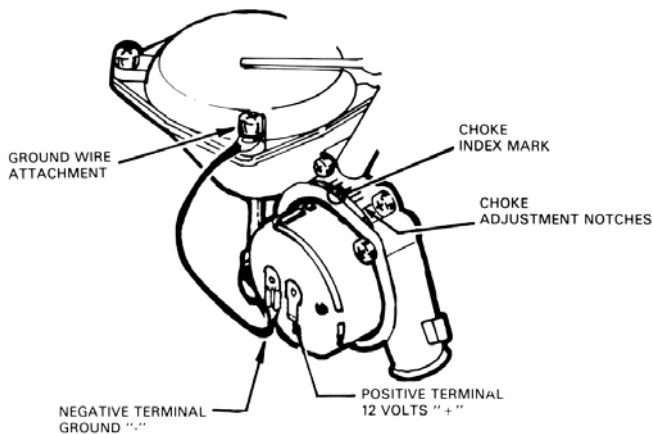

Figure 11

CONVERTING TO ELECTRIC CHOKE:

CAUTION: Electric chokes will not function properly on less than 12 volts.

1. Turn the ignition key on the running position. Use a volt meter and locate a +12 Volt source. (Not the coil) For example, the input side of the resistor, a fuse panel terminal or any common +12 Volt terminal that has power only when the ignition switch is "on".
- NOTE:** Be sure your source is +12 Volts, and only when the ignition switch is in the "Run" position.
2. Do not use the plus side of the coil. This terminal is only 8 or 9 volts and will not operate the choke.
 3. Follow carburetor manufacturer's instructions.

SETTING THE ELECTRIC CHOKE:

1. There will be an index mark on the choke cap and there will be adjustment notches on the choke cap housing. For initial setting make sure index mark is in the center of the adjustment notches. See Figure 11.
2. Final setting will depend on climate conditions for your area. Cap indicates directions for richer or leaner choke setting.

DIVORCED CHOKES:

NOTE: Where design permits, Edelbrock duplicates the stock manifold choke mounting configuration. For applications where this is not possible, due to carburetor selection or manifold design, Edelbrock has incorporated on the manifold a special heat pad, which will allow the automatic choke function to be retained under the following situations.

1. Carburetor choke linkage determines choke blade opening by pushing up or pulling down.
2. Chevrolets may use the stock assembly unless carburetor selection requires a different choke opening direction.
3. Thermostat assembly (GM part no. 3973497 for chokes which open with an upward motion, or GM part no. 3989058 for chokes which open with a downward motion) and dust cover (GM part no. 14006795 for both applications) may be purchased from your Chevrolet dealer. NAPA #2-313 or equivalent may also be used in place of GM #3973497.
4. These same assemblies may be used on most Edelbrock manifolds for GM engines, although the choke rod must be fabricated for non-Chevrolet applications.
5. Check Edelbrock choke rod numbers below. These are available from Edelbrock dealers or from Edelbrock directly, if unavailable locally.

CHOKE RODS:

9171 - 4-V Rochester divorced choke rod for small-block Chevrolets (Performer 2101, 3701).
 9179 - 4-V Rochester divorced choke rod for big-block Chevrolets (Performer 2161, 3761).

SETTING DIVORCED CHOKE:

1. Install correct thermostat on manifold.
2. Refer to individual manifold instruction sheet for Edelbrock choke rod part number and choke.
3. Choke must be set with engine cold.
4. Be sure carburetor and thermostat are securely bolted in place.
5. Insert plain end of Edelbrock choke rod in rolled eye of spring and clip end in carburetor linkage. See Figure 12.
6. Open throttle by hand and push on choke blade. By bending link, adjust to the same pre-load condition that you felt with the stock manifold. See Figure 12.
7. When pre-load is set, remove link from carburetor end. Slide cover over link to base. Push down on cover until it snaps in place. See Figure 12.
8. Replace clip end carburetor linkage and install clip furnished. See Figure 12.
9. Open throttle by hand and work choke linkage by hand. Choke should work freely from closed to open position. If there is any bind, check cover for rod clearance and re-shape rod to clear.

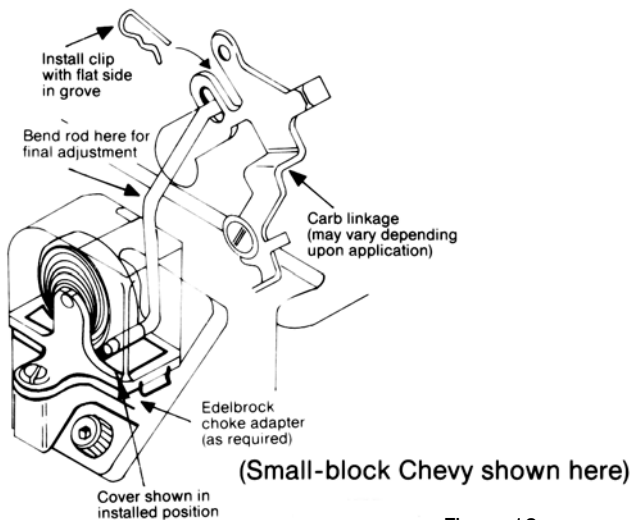

Figure 12

TROUBLESHOOTING:

Below is a list of the most common problems experienced after a manifold installation. Under each problem, we have listed several possible causes for the problem.

WATER LEAKS:

1. Failure to use new or current gaskets and proper sealant.

CAUTION:

1. Fel-Pro brand Permatorque gaskets are not recommended for use with aluminum intake manifolds. Fel-Pro Printoseal gaskets are recommended.
2. Failure to use Teflon tape, pipe dope or liquid Teflon on fitting and bolt threads as recommended.
3. Failure to replace questionable hoses or clamps.
4. Use of chrome thermostat housing.

VACUUM LEAKS:

1. Failure to replace questionable hoses.
2. Incorrect re-connection of vacuum hoses.
3. Forgetting to connect a hose.
4. Incorrect manifold gaskets or carburetor gaskets. Do not use Fel-Pro Permatorque gaskets for any aluminum intake manifold. Use the correct Edelbrock, OEM replacement, or Fel-Pro Printoseal gaskets.
5. Failure to use Edelbrock carburetor spacer plates when recommended.
6. Failure to re-torque manifold.

FOULED PLUGS AND OIL LEAKS:

1. Failure to re-torque manifold.
2. Incorrect manifold gaskets and sealant.
3. Faulty PCV valve or use of incorrect PCV valve.
4. End seal slippage or failure to use enough RTV sealant in place of end seals.

AUTOMATIC CHOKE PROBLEMS:

Failure to follow instructions completely or clogged exhaust crossover passages.

POOR MILEAGE AND/OR PERFORMANCE:

1. Incorrect selection of manifold for engine application.
2. In correct carburetor choice.
3. Re-curving distributor curves when not recommended.
4. Incorrect automatic choke setting.
5. Failure to adjust automatic transmission shift point per instructions, if necessary.
6. Improper vacuum hose installation (leaking).
7. Failure to set timing to specification with timing light.
8. Failure to replace plugs, wires, points and/or rebuild carburetor if necessary.
9. Restricted air flow due to dirty air cleaner elements.

MILEAGE TIPS:

1. Due to varied conditions, such as weather, traffic and types of driving, average mileage should be computed with a minimum of 4 to 5 tanks of gasoline.
2. Install a vacuum gauge and program your driving habits to keep the vacuum as high as possible at all times.
3. Keep tires inflated to highest pressure recommended by manufacturer.
4. Keep air filter clean and replace when needed.
5. Re-adjust automatic choke for winter and summer.
6. Use light throttle when accelerating.
7. Keep points and timing to maximum factory setting at all times.
8. Check spark plugs and ignition wires at least every 10,000 miles and replace if questionable.
9. Using a vacuum gauge, keep carburetor adjusted to highest idle vacuum.

NOTE: For automatic transmission cars, adjust idle in gear. Idle adjustments must be made at the manufacturer's specified rpm.

Edelbrock replacement manifolds are designed to maintain high vacuum at cruise throttle position and sharp throttle response with minimum throttle opening. Unnecessary demands on the added performance will affect mileage.

REFERENCE SYMBOLS & NOMENCLATURE

MANIFOLD INSTALLATION AND CARBURETOR SELECTION SIMPLIFIED

To simplify the selection of all parts necessary for a complete intake manifold selection, Edelbrock has developed a system which includes packaged accessory pieces intended to allow "one stop" shopping for manifold installations. Under each listed manifold there is a coding. These letters refer to the "symbol nomenclature" listed on this page and in the Edelbrock catalog. This nomenclature gives specific information about what parts will be needed for each Edelbrock manifold installation. Specific carburetor features are also identified, especially with regard to OEM emissions equipment.

SYMBOL NOMENCLATURE:

- A. Carb will work with non-EGR or pre-emission control system.
- B. Carb will work with EGR systems.
- C. Adapter for this Carb supplied with this manifold.
- D. No Carb lever for the auto. trans. kickdown rod.
- F. Use manifold-to-manifold base gasket same year/model as vehicle, unless base gasket supplied with Carb.
- H. Carb has provision for evaporative canister.
- I. Carb has no provision for evaporative canister.
- J. Do not use Ford variable venturi OEM 2-bbl. Carb.
- K. Carb requires stud, nut, and washer kit #8008 (5/16-18 x 1-3/8") or #8024 (5/16-18 x 1-3/4"). Determine length needed before installing.
- L. Carb requires #8003 (1/4" rod extension), #8004 (5/16" rod extension), or #8022 (cable extension) for Chrysler auto.trans. Determine size needed before installing.
- M. Ford EGR adapter needed.
- N. Carb will accept factory cruise control.
- O. Carb has manual choke only
- P. Carb is NOT a stock replacement part.

Edelbrock Corporation.
2700 California Street • Torrance, California 90503

IF YOU HAVE ANY QUESTIONS REGARDING THIS PRODUCT OR INSTALLATION,
PLEASE CONTACT OUR TECHNICAL DEPARTMENT

From 7:00 am To 5:00 pm, PST, Monday through Friday at:
Edelbrock Corporation. 2700 California Street, Torrance, CA 90503
Tech Telephone Number: (800) 416-8628 or (310)-782-2900
Tech department Fax (310)-972-2730
Email: Edelbrock@Edelbrock.com