

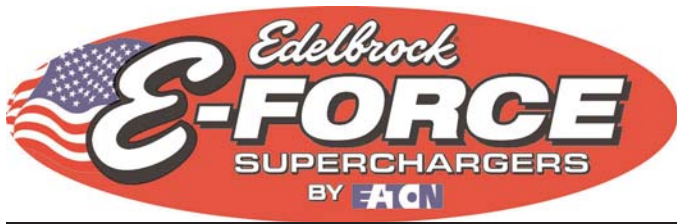

Edelbrock 2010-2012 Camaro SS Supercharger

Part #'s: 1596, 1597, 1598, 1599, 15997



Edelbrock E-Force Supercharger System for the 2010-2012 Camaro SS

Installation Instructions

INTRODUCTION

Thank you for purchasing the Edelbrock 6.2L GM Supercharger System for the 2010 Chevy Camaro. The Edelbrock E-Force Supercharger System for the 2010 Camaro SS utilizes Eaton's new Gen VI TVS Supercharger rotors, featuring a four lobe design with a full 160 deg. of twist for maximum flow, minimum temperature rise, quiet operation, and the reliability for which Eaton is known. The Edelbrock Supercharger is a complete system that maximizes efficiency and performance by minimizing air restriction into, and out of, the supercharger. This results in maximum airflow, with minimal temperature rise and power consumption. The supercharger housing itself is integrated into the intake manifold for a seamless design with minimal components, eliminating the possibility of vacuum leaks between gasket surfaces. The system also utilizes a front drive, front inlet configuration giving it the shortest, least restrictive inlet path on the market. The supercharger is inverted, expelling the air upward. Air pressure then builds in the plenum, before being drawn down through each of two intercooler cores, oriented horizontally, next to, and below the supercharger outlet. After passing through the intercooler cores, the air travels through the long 12" individual intake runners, which route underneath the supercharger housing to the cylinder head ports, in a horizontal, nested configuration. The upper plenum area is enclosed by a top cover that has been designed to provide an appealing and distinctive under-hood appearance. This configuration allows for a compact package that can fit under the stock hood and cowl of the Camaro, without sacrificing runner length, or intercooler area. The E-Force supercharger features a uniquely styled plenum, and includes matching side covers. The Edelbrock supercharger provides neck snapping performance that is safe to operate on a completely stock engine. It is 50-state emissions legal, and can be had with an optional 5-year 100,000 mile warranty so that there are no worries when installing it on a brand new car.

TOOLS REQUIRED

- Jack and Jack Stands
OR Service Lift
- Panel Puller
- Ratchet and Socket Set including: 7mm, 8mm, 10mm (standard, deep and universal), 12mm (deep), 13mm, 15mm (deep), 18mm, 21mm (deep), 24mm
- Wrenches including: 8mm, 13mm, 16mm, 18mm, 13/16", 3/4"
- Crescent Wrench
- 12" Ratchet Extension Bar
- 1/2" Breaker Bar
- Flat Blade & Phillips Screwdrivers
- Compressed Air
- Torx-20 Driver
- Allen Wrenches including: 6mm, 8mm
- 3/8" Fuel Line Removal Tool
- Torque Wrench
- Needle Nose Pliers
- Pliers
OR Hose Clamp Removal Tool
- Pneumatic or Power Drill
- 1-1/8" or larger Uni-bit
- Impact Wrench
- Red & Blue Loctite or equivalent
- O-ring Lube
- Thread Sealing Compound
- Anti-seize
- Masking Tape
- J-42386-A Flywheel Holding Tool
- Soldering Iron

Edelbrock LLC, 2700 California Street, Torrance, CA 90503
Toll-Free Tech Line: 1-800-416-8628 Office/Sales Line: 310-781-2222

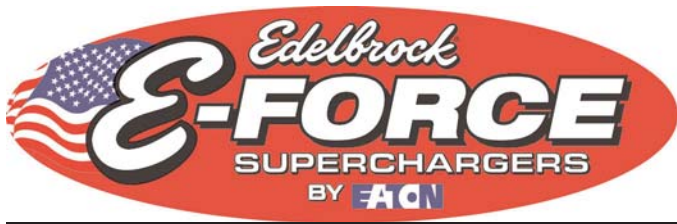

Edelbrock E-Force Supercharger System for the 2010-2012 Camaro SS

Installation Instructions

IMPORTANT WARNINGS

Before beginning installation, use the enclosed checklist to verify that all components are present in the box then inspect each component for damage that may have occurred in transit. If any parts are missing or damaged, contact Edelbrock Technical Support, not your parts distributor.



WARNING: Installation of this supercharger will result in a significant change to the performance characteristics of your vehicle. It is highly recommended that you take some time to familiarize yourself with the added power, and how it is delivered, in a controlled environment. Take extra care on wet and slippery roads, as the rear tires will be more likely to lose traction, with the added power. It is never recommended to turn off your vehicles traction control system.

Proper installation is the responsibility of the installer. Improper installation will void all manufacture's standard warranties and may result in poor performance and engine or vehicle damage.

Due to the complexity of the Edelbrock E-Force Supercharging system, it is recommended that this system only be installed by a qualified professional with access to a service lift, pneumatic tools, and a strong familiarity with automotive service procedures. To qualify for the optional supplemental warranty, it is necessary to have this system installed by a Certified ASE Technician, GM Dealership, or an Authorized Edelbrock Installer. Failure to do so will void and/or disqualify any and all optional supplemental warranties offered with this system. Please contact the Edelbrock Technical Support department if you have any questions regarding this system and/or how your installer of choice will affect any warranty coverage for which your vehicle may qualify.

Any previously installed aftermarket tuning equipment must be removed and the vehicle returned to an as stock condition before installing the supercharger.

Any equipment that directly modifies the fuel mixture or ignition timing of the engine can cause severe engine damage if used in conjunction with the Edelbrock E-Force Supercharger System. This includes, but is not limited to: ignition boxes, air/fuel controllers, OBDII programmers, and any other device that modifies signals to and/or from the ECU. Aftermarket bolt-on equipment such as underdrive pulleys or air intake kits will also conflict with the operation of the supercharger and must be removed prior to installation. Use of any of these products with the E-Force Supercharger could result in severe engine damage.

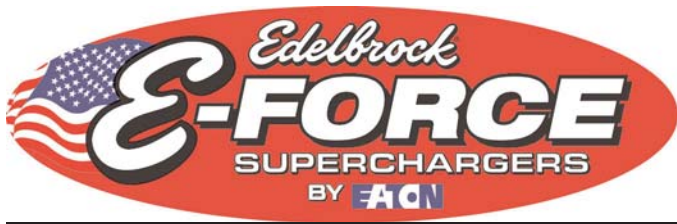

Edelbrock E-Force Supercharger System for the 2010-2012 Camaro SS

Installation Instructions

IMPORTANT WARNINGS (CONTINUE)



91 octane or higher gasoline is required at all times. If your vehicle has been filled with anything less, it must be run until dry and refilled with 91 or higher octane gasoline twice prior to installation.

Failure to use the required 91 octane gasoline or higher could permanently damage your engine. Any failures associated with not using premium 91 octane gasoline or higher, will be ineligible for warranty repairs.

Edelbrock periodically releases improved versions of the calibration file found on the supplied handheld programmer. Check the website to ensure you have the latest version, as described in step #163.

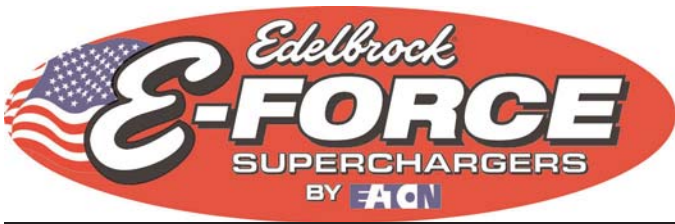

**Edelbrock E-Force Supercharger System for
the 2010-2012 Camaro SS**

Installation Instructions

INSTALLATION HARDWARE IDENTIFICATION GUIDE

Bag #1

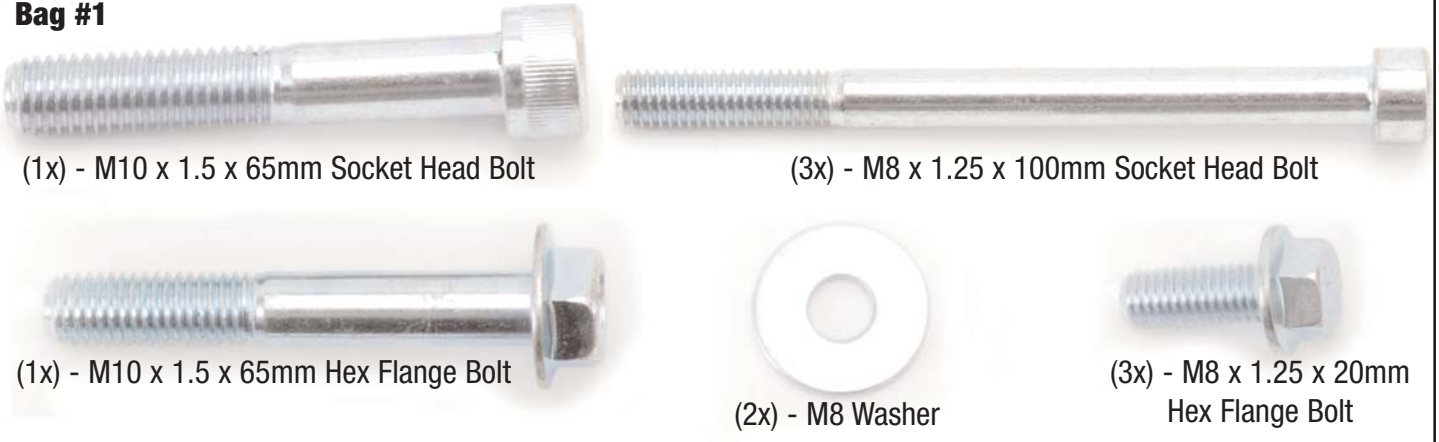

Bag #2

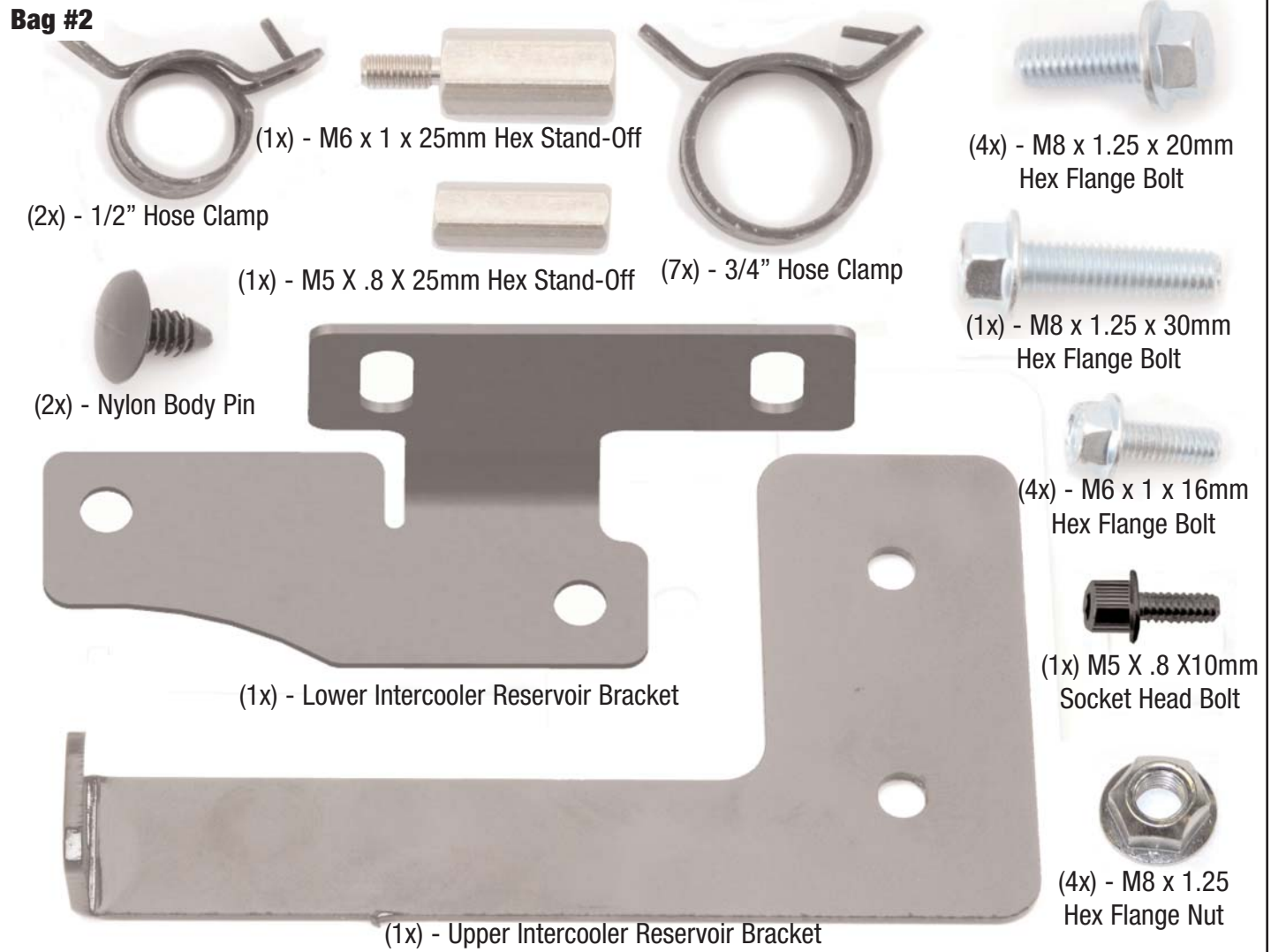

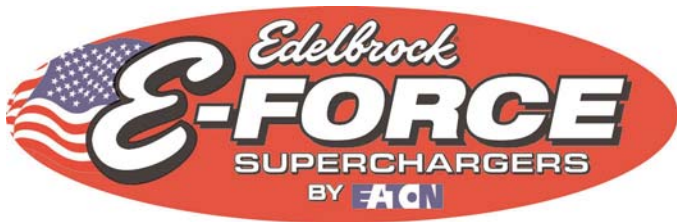

Edelbrock E-Force Supercharger System for the 2010-2012 Camaro SS

Installation Instructions

Bag #3



(11x) - M8 x 1.25 x 25mm
Countersunk Socket Head Bolt



(8x) - M6 x 1 x 45mm
Hex Flange Bolt



(4x) - M6 x 1 x 12mm
Socket Head Bolt



(2x) - M6 x 1 x 16mm
Button Head Bolt

Bag #4

(1x) - GM Factory Harmonic Balancer Bolt



(1x) - M16 x 2 x 120mm Hex Bolt



(1x) - Crank Pinning Drill Guide



(1x) - 1/4" x 3/4" Steel Dowel



(1x) - 15/64" High Speed Steel Drill Bit



(1x) - .2500" Reamer

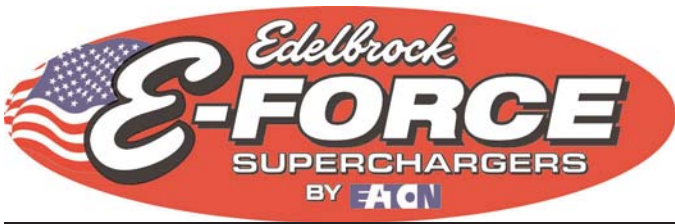

Edelbrock E-Force Supercharger System for the 2010-2012 Camaro SS

Installation Instructions

Bag #5

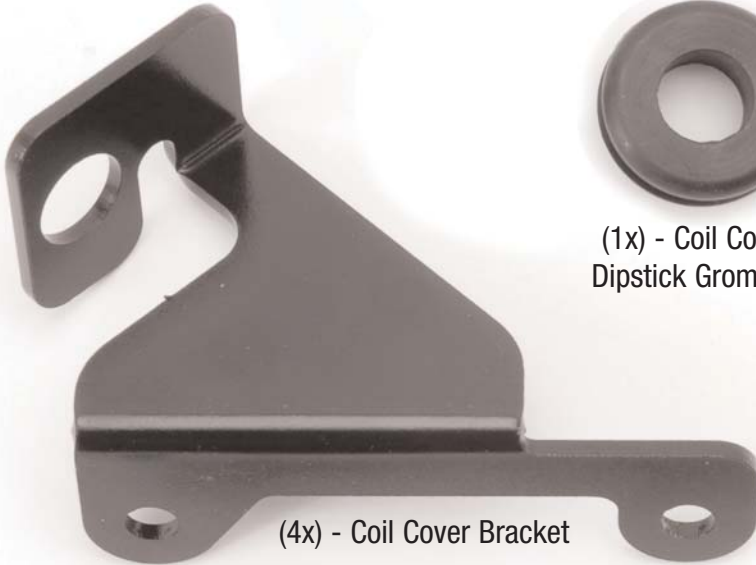

(1x) - Coil Cover
Dipstick Grommet

(4x) - Coil Cover Bracket



(4x) - Coil Cover Bracket Grommet



(4x) - Coil Cover Retainer Stud



(4x) - Coil Cover Standoff

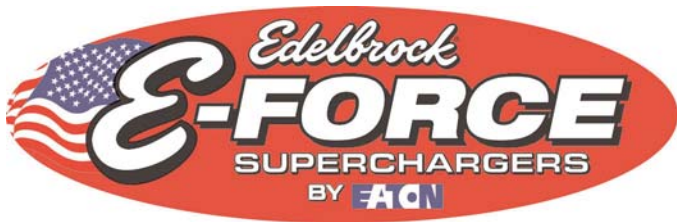

Edelbrock E-Force Supercharger System for the 2010-2012 Camaro SS

Installation Instructions

HOSE IDENTIFICATION GUIDE

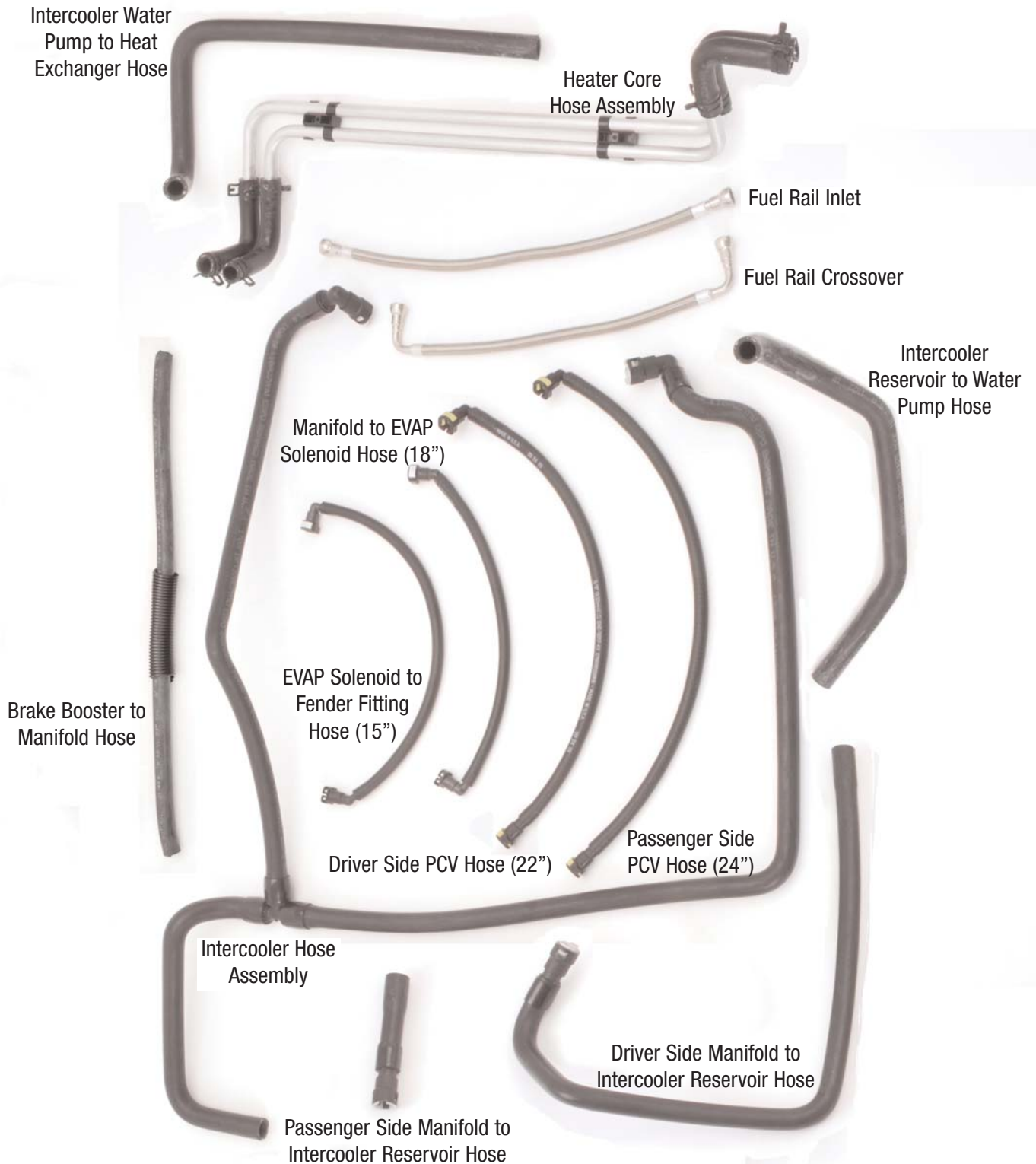

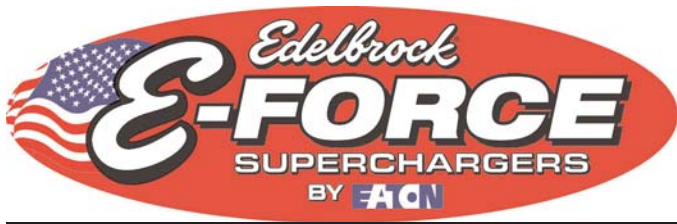

Edelbrock E-Force Supercharger System for the 2010-2012 Camaro SS

Installation Instructions

Test Flash Procedure

Use the supplied programmer to flash the ECU and verify its compatibility.

- Original Equipment Manufacturers often release updates to the computer programming for your vehicle. Edelbrock highly recommends that you verify, with your new car dealer, that your vehicle is equipped with the latest software version from your vehicle manufacturer, before attempting to load the Edelbrock tune.”
- Confirm that you have the latest calibration by checking the Edelbrock website (http://www.edelbrock.com/automotive_new/mc/superchargers/software-tech.shtml) and entering your serial number in the search field. (Your 4 digit supercharger serial number is written on your kit checklist paperwork, and is also stamped on the front bolt bosses of your supercharger—first 2 digits on RH bolt boss, 2nd 2 digits on LH bolt boss.) Once you have found the latest tune on the site, power on the programmer, press the left arrow and select the Device Info option. Scroll down to Tune Version and compare that number to the one on the site. If they are different, download the new calibration as instructed on the website.
- Put the car into Acc mode, but don't start the vehicle.
- Connect the supplied PCM cable to the OBD-II connector.
- Use directional pad to highlight Program Vehicle option and press Select button.
- Use directional pad to highlight Preprogrammed Tune option and press Select button.
- Read disclaimer then press Select to continue.
- Verify ignition is in the 'Key On' position but that the engine is not running then press Select.

- Use directional pad to highlight your vehicle and transmission combination then press Select.
- Use directional pad to highlight Begin Program then press Select.
- Depending on your specific drivetrain configuration, several separate operations may take place during this step. Completion of each operation will cause the progress bar to reset to zero.

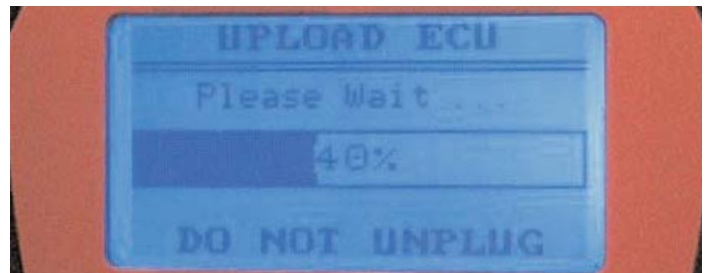

DO NOT unplug the programmer until prompted.

- Turn the car off when prompted to do so by the handheld programmer.
- Read parting message from programmer then press Select to continue.
- Unplug the programmer cable from the OBD-II port.

In the rare occurrence that you encounter an error message during the test flash procedure, please refer to pg. 27, titled Email Edelbrock Your Stock PCM Calibration.

Post Successful Test Flash

If you are ready to install the supercharger, proceed to Step 1 of the Supercharger Installation

OR

If you wish to return the ECU back to the factory calibration, such that the vehicle can still be driven until you are ready to begin the installation, then:

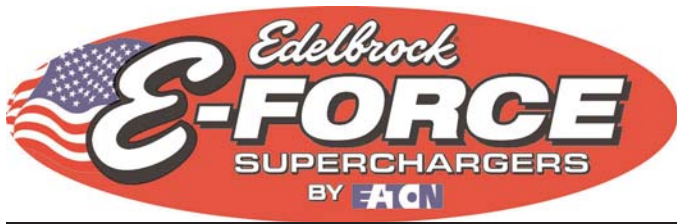

Edelbrock E-Force Supercharger System for the 2010-2012 Camaro SS

Installation Instructions

- Put the car into Acc mode, but don't start the vehicle.
- Connect the supplied PCM cable to the OBD-II connector.
- Use directional pad to highlight Program Vehicle option and press Select button.
- Use directional pad to highlight Return To Stock option and press Select button.
- Follow the on screen instructions. Turn the car off when prompted to do so by the handheld programmer.
- Read parting message from programmer then press Select to continue.
- Unplug the programmer cable from the OBD-II port.
- When you are ready to install the supercharger, proceed with Step 1 and you will be prompted to re-flash the ECU towards the end of the installation procedure.

Supercharger Installation

1. Open trunk and lift trunk liner to access plastic hold down. Unscrew plastic hold down then remove air compressor and foam support.
2. Use a 10mm socket to loosen and remove the negative battery terminal.
3. Lift the protective cover then use a 10mm socket to loosen and remove the positive battery terminal.



4. Lift and support the front end of the vehicle using a service lift or jack and appropriately load rated jack stands then loosen and remove the lug nuts from both front wheels. Remove the wheels and set them aside.
5. Use a T20 Torx wrench to remove the three bolts on each side holding the front and the two holding the rear of the front wheel fender liners. Use a panel puller to remove the five body pins on each side that retain the inner fender wells then remove them and set them aside.

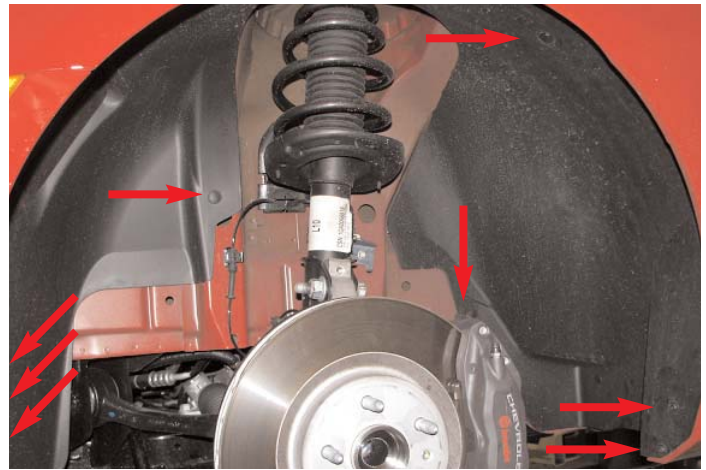

6. Reach in through the wheel wells with a 10mm socket to remove the four bolts at the front of each side of the fascia then use a 7mm socket to remove the two bolts on each side of the front fascia.



7. Disconnect the fog lamp electrical connectors and the fascia wiring harness connector on the passenger side.

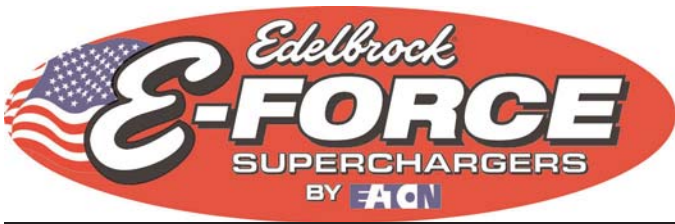

Edelbrock E-Force Supercharger System for the 2010-2012 Camaro SS

Installation Instructions

8. Use a 10mm socket to remove the two bolts retaining the bottom of the fascia.



9. Use a panel puller to remove the six body pins holding the top of the fascia then use a 10mm socket to remove the bolt at each end of the top of the fascia.

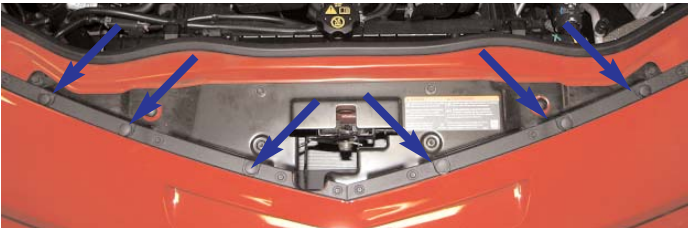

10. The front fascia can now be pulled forward and off the car and set aside.

11. Disconnect the Mass Airflow Sensor connector.

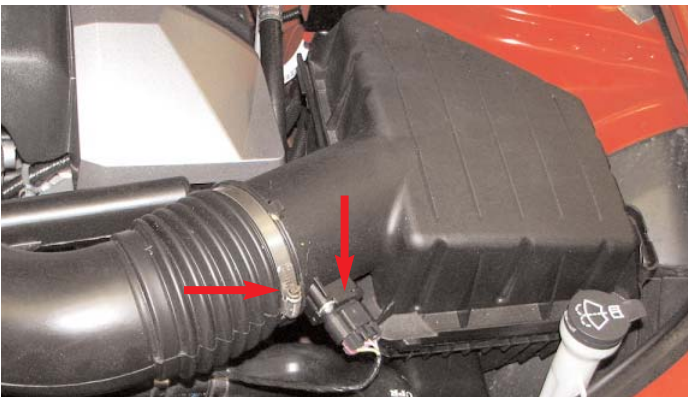

12. Use a flat head screwdriver to loosen the worm clamp holding the inlet tube to the air box lid then remove the air box lid by pushing the lock tabs back.

13. Remove the oil fill cap and remove the plastic engine cover. Reinstall the oil fill cap.

14. Disconnect passenger side PCV tube from the valve cover then use a flat head screwdriver to loosen the worm clamp retaining the air intake tube to the throttle body. Remove and discard the air intake tube and PCV hose.

15. Use a 15mm socket and a breaker bar to loosen the tensioner and remove the serpentine belt.



16. Disconnect the Electronic Throttle Control connector on the passenger side of the throttle body.

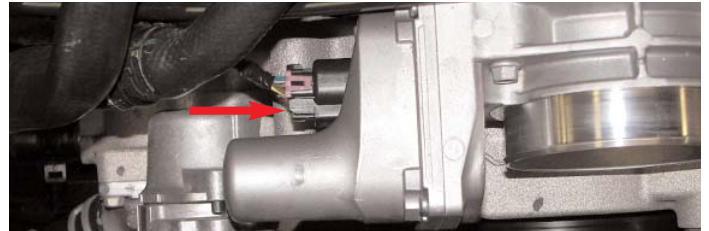

17. Use a 10mm socket to remove the four bolts retaining the throttle body and set it aside.



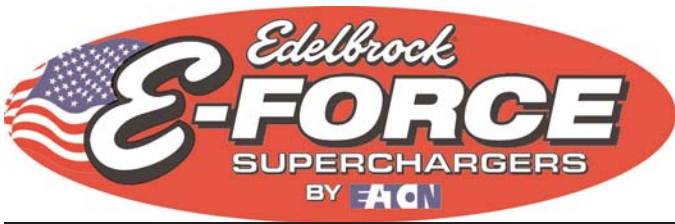

Edelbrock E-Force Supercharger System for the 2010-2012 Camaro SS

Installation Instructions

18. Push down the white tab on the front EVAP hose fittings and disconnect them from the manifold and the EVAP solenoid.

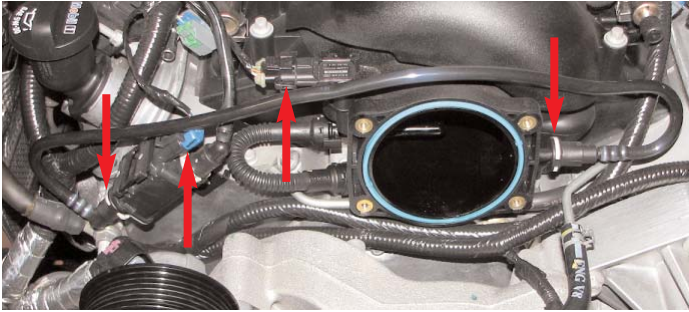

19. Disconnect the Manifold Air Pressure sensor and EVAP solenoid electrical connectors.

20. Use a 3/8" Fuel Line Removal Tool to disconnect the fuel line from the fuel rails and from the passenger side fender fitting. Use a shop rag to absorb any excess fuel.

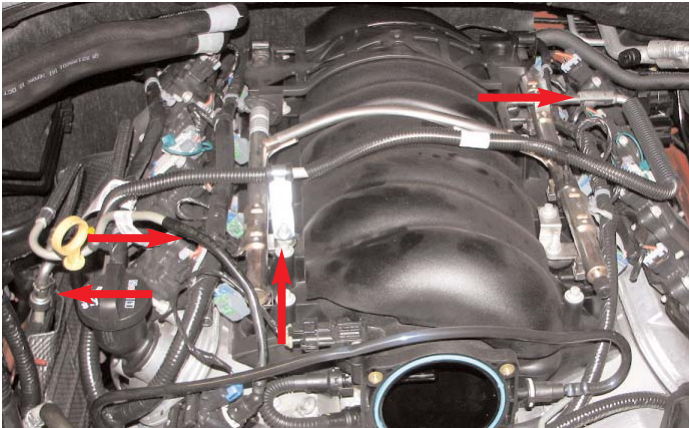

21. Use a 10mm socket to remove the nut holding down the fuel line clamp then remove the fuel line and clamp.

22. Disconnect the two ignition harness connectors, the eight spark plug wires from the ignition coils and the eight fuel injector electrical connectors.

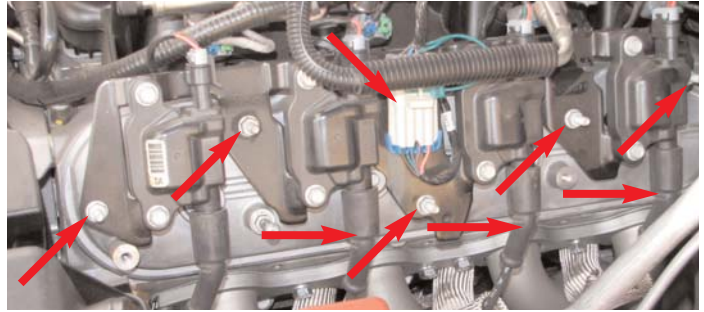

23. Use a 10mm deep socket to remove the five studs retaining each of the ignition coil brackets to the valve covers. Lift and remove the coil brackets as an assembly.

24. Disconnect the EVAP hose from the EVAP Solenoid and the passenger side fender fitting.

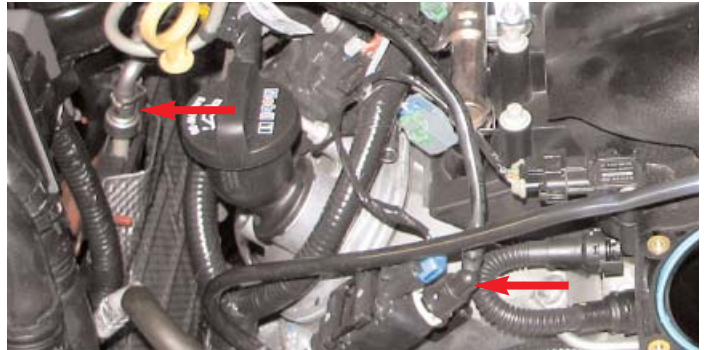

25. Use a 10mm socket to remove the nut on the driver side and remove the plastic manifold webbing.

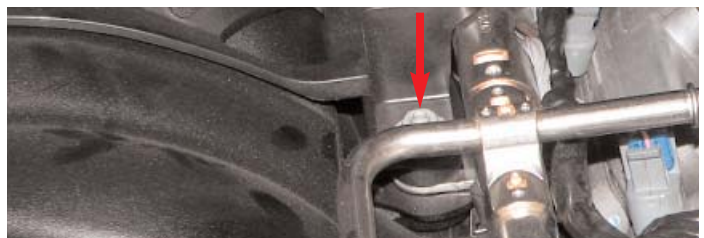

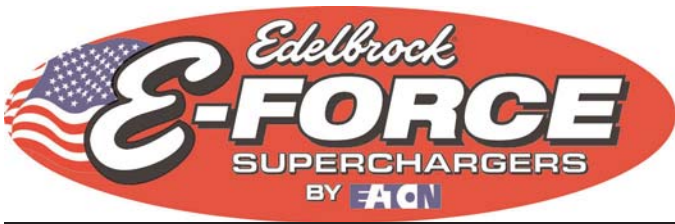

Edelbrock E-Force Supercharger System for the 2010-2012 Camaro SS

Installation Instructions

26. Use an 8mm socket to remove the manifold bolt on the driver side retaining the fuel rail bracket.



27. Use a 10mm deep socket to remove the four fuel rail studs. Remove the fuel rail bracket then remove the rails by lifting the injectors straight up out of their provisions then work the rails forward and set them aside.

28. Disconnect the PCV tube from the engine valley cover.

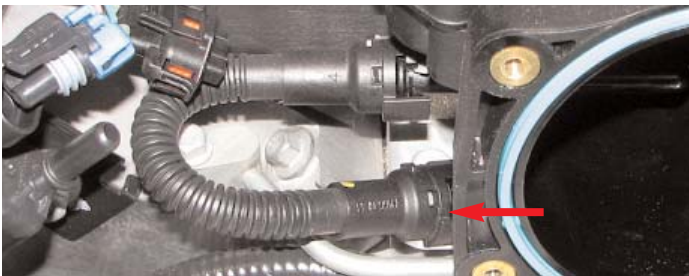

29. Remove the manifold insulating cover.



30. Use an 8mm socket to remove the nine remaining manifold bolts. Note that the rearmost passenger side bolt will come out with the manifold and that it is necessary to rotate the manifold towards the passenger side to remove the rearmost driver side bolt and the bracket it retains.



31. Reach behind the manifold from the driver side to lift the gray tab and depress the black tab to disconnect the oil pressure sensor electrical connector.

32. Use a pair of hose clamp pliers to loosen the clamp retaining the vacuum hose to the brake booster fitting and disconnect the hose. It will be removed with the manifold.



33. Lift the rear of the manifold over the oil pressure sensor and pull it forward to remove it. Remove the o-ring seals from the manifold flanges and retain them for later reuse.

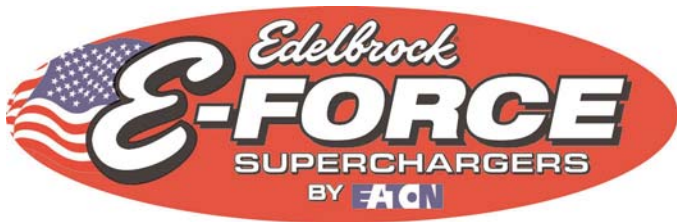

Edelbrock E-Force Supercharger System for the 2010-2012 Camaro SS

Installation Instructions

34. Use a clean shop rag to wipe down the intake flange of both cylinder heads then put a small strip of masking tape over each port to prevent debris from entering.

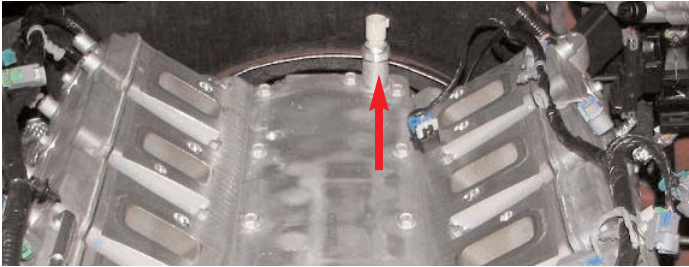

35. Use a crescent wrench to remove the oil pressure sensor from the engine valley plate.

NOTE: Steps #36 - #42 outline the procedure for disabling the Active Fuel Management system found in Camaros equipped with an automatic transmission. Manual vehicles should skip ahead to step #43.

WARNING: AUTOMATIC CAMAROS EQUIPPED WITH STANDARD, NON-AFM LIFTERS MUST USE THE MANUAL VALLEY COVER PLATE. FAILURE TO DO SO WILL RESULT IN ENGINE DAMAGE.

36. Use a 13mm socket to remove the eleven bolts retaining the engine valley plate and remove the plate.

37. Use a T-20 Torx driver to remove the four bolts retaining the plastic solenoid bracket, then pry open the clip at the rear of the plate to remove the bracket.



38. Rotate each solenoid 90° and remove them.



39. Use a T-30 Torx driver to remove the twenty bolts holding the steel sandwich in place and remove it.

40. Remove the plastic and rubber gasket from the valley tray using great care not to damage the seal.

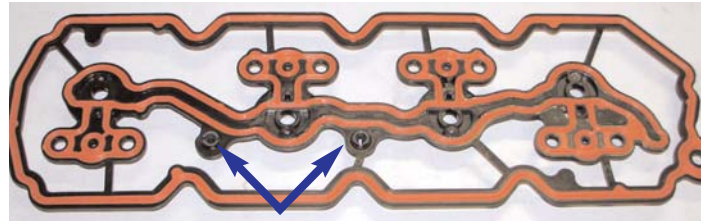

41. Trim the two tabs projecting from the gasket to the base of their tapers. Use a file to remove any burrs then install the gasket in the new valley plate.

42. Install the new valley plate with the gasket in place onto the engine and proceed to step #47.

43. Use a 13mm socket to remove the eleven bolts retaining the engine valley plate and remove the plate. The metal and rubber gasket beneath it will be reused and should be left in place.

44. Use a flathead screwdriver to remove the eight o-ring seals from the underside of the valley plate.

45. Inspect each seal for damage and replace any that have been compromised then install the seals into the supplied valley plate.

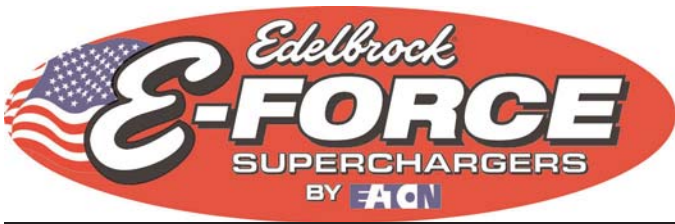

Edelbrock E-Force Supercharger System for the 2010-2012 Camaro SS

Installation Instructions

46. Install the new valley plate on the engine carefully so as not to dislodge the o-rings and line up the bolt holes.



47. Apply anti-seize to the underside of the heads of the eleven countersunk bolts from Bag #3 then use a 5mm Allen tool to install them in the plate. Torque them to 18 ft-lbs from the center out.

48. Apply thread sealant to the threads of the oil pressure sensor then use a crescent wrench to install the sensor in the new valley plate. Reconnect the oil pressure sensor electrical connector.

49. Use a 15mm socket to remove the two bolts retaining the belt tensioner.



50. Place a drain pan below the radiator petcock on the driver side. Remove the radiator cap then loosen the petcock to drain the engine coolant.

51. Disconnect the two heater hoses from the firewall using a shop rag to absorb any excess coolant.



52. Disconnect the two heater hoses from the water pump using a shop rag to absorb any excess coolant.

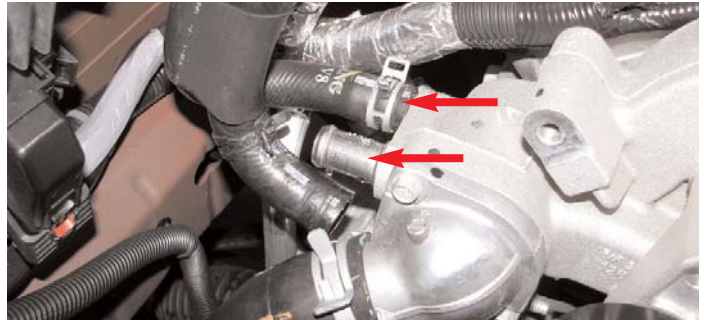

53. Install the supplied Heater Core Hose Assembly to the firewall fittings using the supplied hose clamps. Route the lines between the engine oil dipstick and the fuse box to the fittings on the water pump and secure them with the supplied hose clamps. Note that the hose closer to the passenger side of the firewall will be routed to the fitting closer to the front of the vehicle and vice versa.



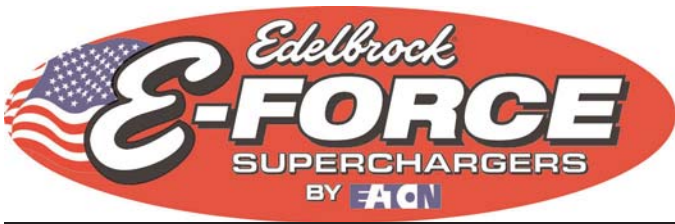

Edelbrock E-Force Supercharger System for the 2010-2012 Camaro SS

Installation Instructions

54. Apply blue Loctite to the threads of the M8 x 20mm bolt supplied in Bag #1 then use a 12mm socket and washer to install the smaller supplied idler pulley onto the supplied idler bracket.



55. Use a 10mm socket to remove the three water pump bolts indicated.

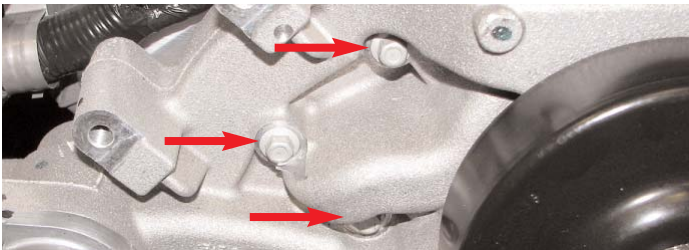

56. Apply blue Loctite to the threads of the M8 x 100mm bolts supplied in Bag #1 then use a 6mm Allen tool to install the idler bracket onto the water pump.



57. Use a 15mm socket to remove the nut retaining the ground strap on the passenger side cylinder head then use a 15mm deep socket to remove the ground strap stud.



58. Apply blue Loctite to the threads of the stock tensioner bolts then use a 15mm socket to install the supplied tensioner bracket to the water pump.

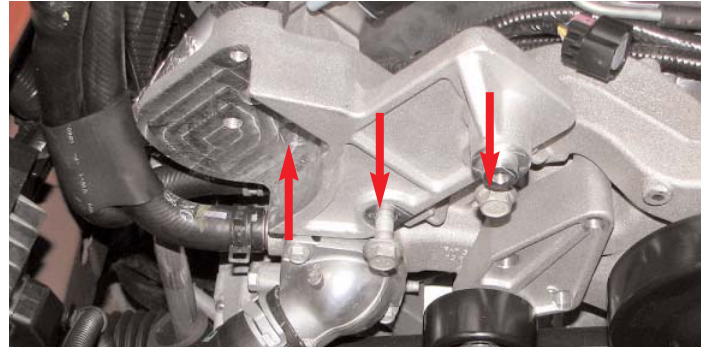

59. Apply blue Loctite to the threads of the M10 x 65mm bolt supplied in Bag #1 then use an 8mm allen to install it in the countersunk bolt hole of the tensioner bracket.

60. Apply blue Loctite to the threads of an M8 x 20mm bolt supplied in Bag #1 then use the supplied washer and a 12mm socket to install the supplied idler pulley onto the tensioner bracket.



61. Apply blue Loctite to the threads of the M10 x 65mm bolt supplied in Bag #1 then use a 15mm socket to install the supplied tensioner onto the tensioner bracket.



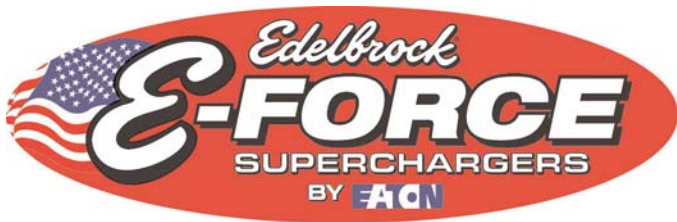

Edelbrock E-Force Supercharger System for the 2010-2012 Camaro SS

Installation Instructions

62. Use a 12mm socket and an M8 x 20mm bolt supplied in Bag #1 to secure the ground strap to the back side of the tensioner bracket.

63. Use pliers to loosen the hose clamps and disconnect the two small upper radiator hoses. Use caution when removing and reinstalling hoses onto plastic fittings.



64. Use a 13mm socket to remove the two bolts holding the fan assembly to the top of the radiator then disconnect the electrical connector on the passenger side of the fan assembly and remove the radiator fans.

65. Disconnect the oil level sensor electrical connector from the passenger side of the oil pan.

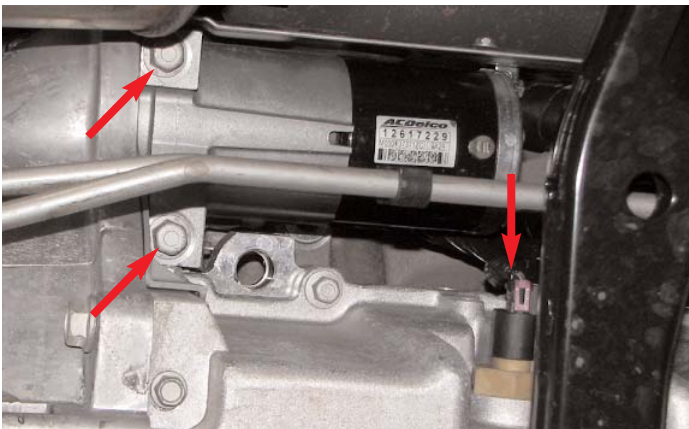

66. Use a 10mm socket to remove the starter support bracket bolt.

67. Use a 13mm socket to remove the two starter bolts.

68. Use an 8mm wrench to remove the three bolts retaining the starter heat shield.

69. Disconnect electrical connector at top of starter.

70. Use a 13mm socket to remove the nuts retaining power wires to the starter.

71. Remove and set aside the starter and bracket.

72. Install GM Flywheel Holding Tool #J-42386-A to prevent the crank from rotating while loosening the balancer bolt and torque the bolts holding it to 37 ft/lbs.

73. Use a breaker bar and a 24mm socket to loosen and remove the crank bolt. A long pipe slid over the breaker bar can be helpful for increasing leverage.

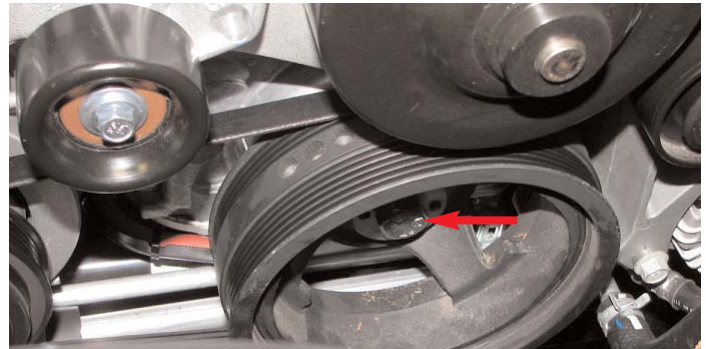

74. Install the drill guide and the M16 x 120mm bolt supplied in Bag #4 onto the end of the crankshaft.

75. Measure 1.7" from the tip of the 15/64" drill bit supplied in Bag #4 and mark the position with a piece of masking tape then drill into the crank through the hole in the guide that has a bushing in it until the tape mark reaches the drill guide.

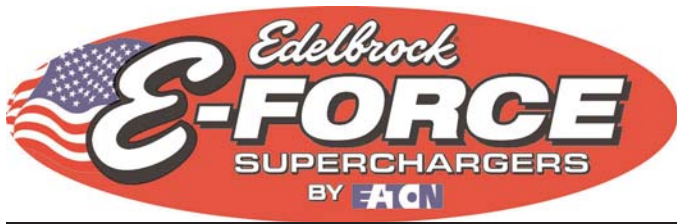

Edelbrock E-Force Supercharger System for the 2010-2012 Camaro SS

Installation Instructions

76. Loosen the bolt holding the drill guide and rotate it until the second hole lines up with the hole drilled in the crank. Use the back side of the ream tool to verify the guide is correctly aligned.

77. Tighten the guide bolt then use compressed air to clean out any metal flakes in the drill hole.

78. Insert the supplied ream tool through the hole and ream the full depth of the hole.

79. Use compressed air to clean out any metal flakes then loosen the bolt and remove the drill guide.

80. Apply red Loctite retaining compound to the supplied crank pin and tap it into the reamed hole until it is flush with the crank snout.

81. Install the crank bolt supplied in Bag #4 and torque it to 37 ft-lbs then rotate it an additional 140°.

82. Remove GM Flywheel Holding Tool #J-42386-A.

83. Lift the starter support bracket and starter into place then use a 13mm wrench to reinstall the power wire onto the starter.

84. Reconnect the starter solenoid electrical connector.

85. Use an 8mm wrench to reinstall the three bolts that hold the starter heat shield in place.

86. Use a 13mm socket to install the two starter bolts.

87. Use a 10mm socket to reinstall the starter support bracket bolt.

88. Lower the fan assembly back into place, reconnect the passenger side electrical connector then use a 13mm socket to reinstall the stock fan assembly bolt on the driver side only, the passenger side will be installed later.

89. Use a panel puller to remove the two body pins from the top of the lower radiator shroud.



NOTE: Convertible models are equipped with a brace that connects the frame extensions, this brace will need to be removed and replaced with the Edelbrock Convertible Brace (Part #15956, Sold Separately) as it interferes with the installation of the Edelbrock heat exchanger.

90. Install the supplied heat exchanger behind the bumper so that the lower bracket holes line up with those in the radiator shroud.

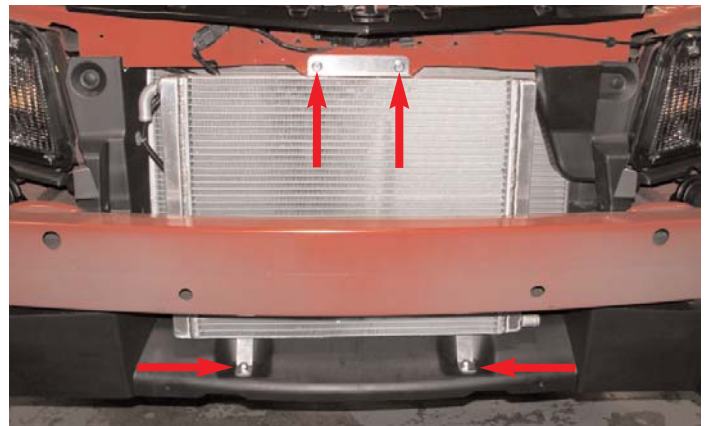

91. Secure the top of the heat exchanger with the two M8 x 20mm bolts supplied in Bag #2 and tighten them with a 12mm socket.

92. Install the M8 nuts and M8 x 20mm bolts supplied in Bag #2 into the holes in the lower heat exchanger brackets then use a 12mm wrench and socket to tighten them.

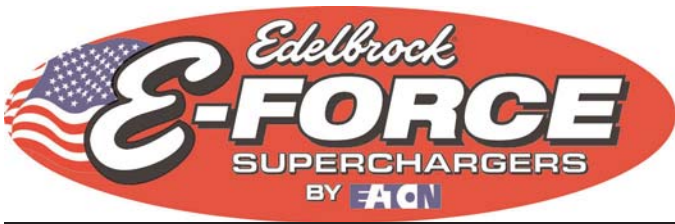

Edelbrock E-Force Supercharger System for the 2010-2012 Camaro SS

Installation Instructions

93. Install the intercooler water pump bracket on the studs located on the back of the passenger side of the bumper. Secure it in place with the M8 nuts supplied in Bag #2 and tighten them with a 12mm wrench.



94. Install the water pump to heat exchanger hose on the passenger side inlet fitting of the heat exchanger and clock it until it contacts the lower radiator shroud. Secure the fitting with a 3/4" hose clamp supplied in Bag #2.



95. Slide the strap over the body of the water pump and install it in the water pump bracket. Rotate the water pump and slide it in and out until it roughly lines up with the position of the hose on the other side of the lower radiator shroud.

96. Use a uni-bit to drill a 1-1/8" hole in the lower radiator shroud to allow the hose to slide onto the water pump outlet fitting.



97. Use the supplied bolt and a 13mm socket to secure the water pump by tightening the strap to the bracket.



98. Slide the hose onto the water pump outlet and secure it with a 3/4" hose clamp supplied in Bag #2.

99. Install the Intercooler Hose Assembly by sliding it down between the radiator fan assembly and the engine. Note that the short hose section will go around the radiator to the outlet of the heat exchanger.

100. Use a unibit to drill a 1-1/8" hole in the radiator shroud on the driver side directly across from the heat exchanger outlet.



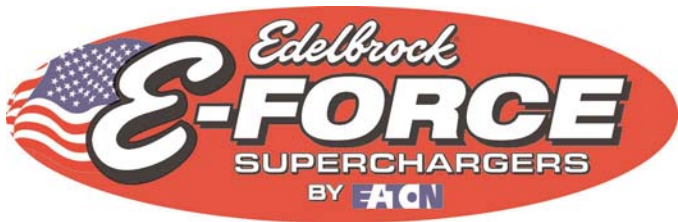

Edelbrock E-Force Supercharger System for the 2010-2012 Camaro SS

Installation Instructions

101. Slide the short section of the Intercooler Hose Assembly through the hole and onto the heat exchanger outlet. Secure it with a 3/4" hose clamp supplied in Bag #2.

102. Mount the brackets, supplied in Bag #2, to the intercooler reservoir with the M6 x 16mm bolts located in Bag #2. Refer to figures 2a & 2b for the specific orientation of the lower bracket for each model year.

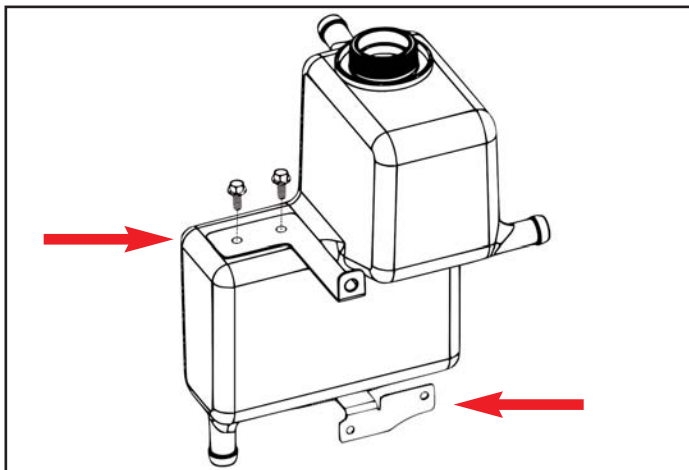

Figure - 1

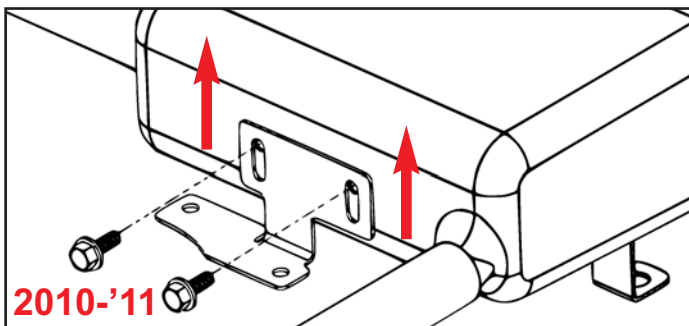

Figure - 2a

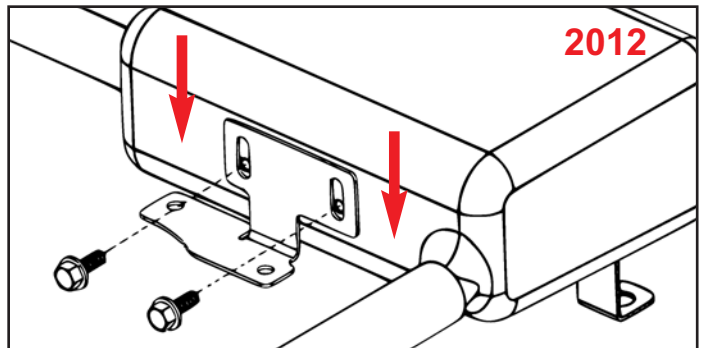

Figure - 2b

103. **FOR 2010 - '11 MODEL YEARS ONLY** Use a 10mm socket to remove the upper-outside bolt from the back-passenger side of the radiator fan; retain the bolt as it will be re-used.

104a. **FOR 2010 - '11 MODEL YEARS ONLY** Use a 13mm wrench to install the standoff stud supplied in Bag #2 in place of the bolt which was just removed. See Figure 3a.

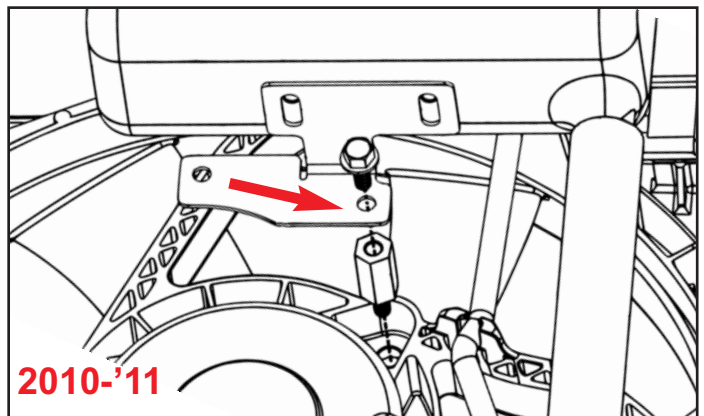
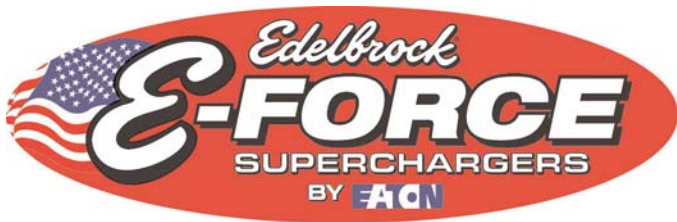

Figure - 3a



Edelbrock E-Force Supercharger System for the 2010-2012 Camaro SS

Installation Instructions

104b. **FOR 2012 MODEL YEAR ONLY** Use a 10mm wrench to install the standoff, supplied in Bag #2, to the stud located on the back of the radiator fan. See Figure 3b

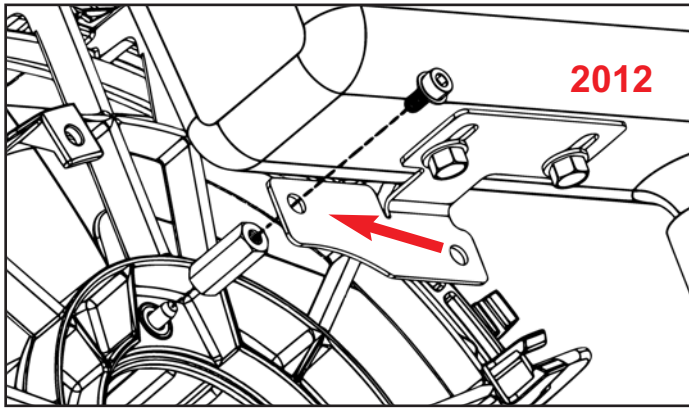

Figure - 3b

105. Install the intercooler reservoir - water pump hose onto the outlet of the intercooler reservoir so that the other end will extend down to the inlet of the intercooler water pump. Secure the hose to the reservoir fitting with a supplied hose clamp. See Figure 4.

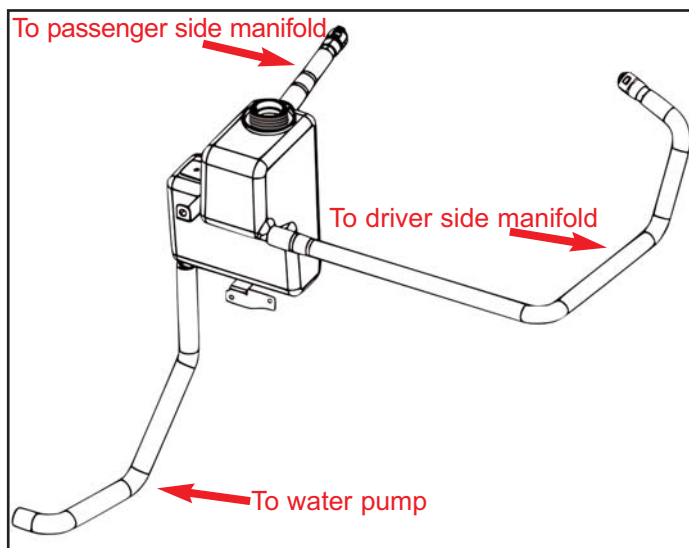

Figure 4

106. Lower the intercooler reservoir and its attached hose down into the passenger side of the engine bay so that the lower bracket will line up with the mounting hole (Refer to the Figure that corresponds to your model year; "3a" or "3b"), the upper bracket will line up with the passenger side radiator fan assembly bolt and the hose will mate up to the intercooler water pump.

107. Use a 13mm (10mm for 2012 Models) socket to reinstall the stock radiator fan assembly bolt through the upper reservoir bracket.



108a. **FOR 2010 - '11 MODEL YEARS ONLY** Secure the lower intercooler reservoir bracket to the back of the fan by using a 10mm socket to re-install the stock bolt onto the standoff stud. (Refer to Figure "3a")

108b. **FOR 2012 MODEL YEAR ONLY** Secure the lower intercooler reservoir bracket to the back of the fan by using a 4mm allen to install the M5 X 10mm bolt, supplied in bag 2, onto the spacer. (Refer to Figure "3b")

109. Secure the intercooler reservoir to water pump hose to the inlet of the water pump with a supplied hose clamp.



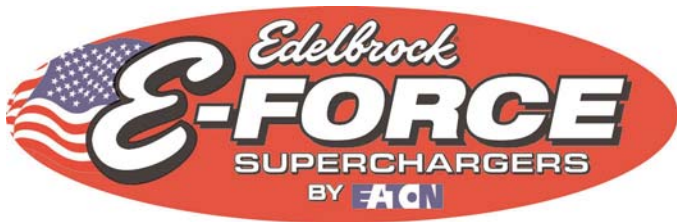

Edelbrock E-Force Supercharger System for the 2010-2012 Camaro SS

Installation Instructions

110. Install the factory o-ring intake seals into the machined grooves of the supercharger flanges.

111. Install the factory throttle body o-ring into the machined groove on the supercharger air inlet.

112. Install the Manifold to EVAP Solenoid Hose to the fitting directly below the supercharger hub snout and the Driver Side PCV Hose to the straight fitting on the driver side of the air inlet.

113. Connect the TMAP harness to the TMAP sensor at the rear of the supercharger manifold.



114. Remove the tape covering the intake ports. Since two of the stock manifold bolt hole provisions in the cylinder heads break into the crankcase and are not used with this supercharger, install the button head bolts supplied in Bag #3 in the front passenger side and rear driver side bolt holes to ensure a good seal. With the assistance of one or more people, lift the supercharger assembly onto the engine.

115. Connect the Manifold to EVAP Solenoid Hose attached to the manifold to the bottom fitting on the EVAP solenoid by routing the hose down and behind the idler pulley bracket.

116. Use a 10mm universal socket to install the M6 x 45mm intake manifold bolts supplied in Bag #3 and torque them to 89 in/lbs in the sequence shown below.

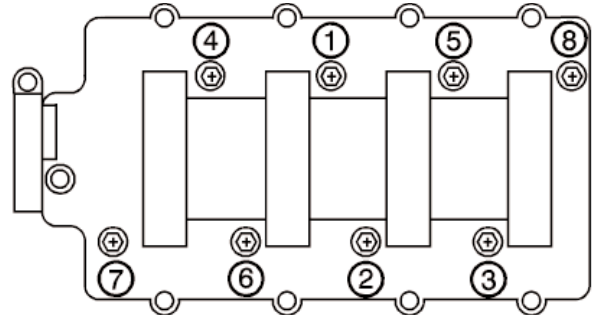

117. Route the supplied serpentine belt according to the diagram below, except for the idler pulley adjacent to the tensioner. Use a 16mm wrench to push the tensioner in enough for the belt to slip on the idler pulley then inspect the belt installation to make sure it is properly aligned.

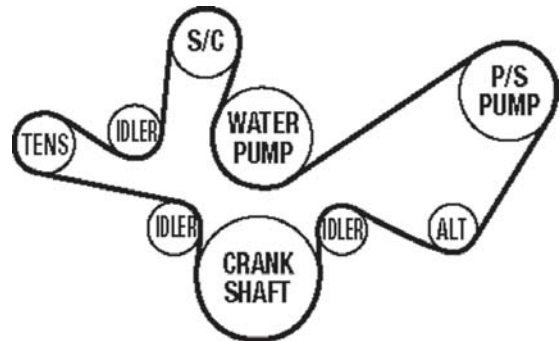

118. Apply o-ring lube to the seals of each of the fuel rail fittings. Use a 13/16" wrench to install the plug in the rear of the driver side rail and a 3/4" wrench to install the crossover fittings in both rails as well as the inlet fitting at the rear of the passenger side rail. Clock the inlet fitting to the rounded side of the fuel rail.



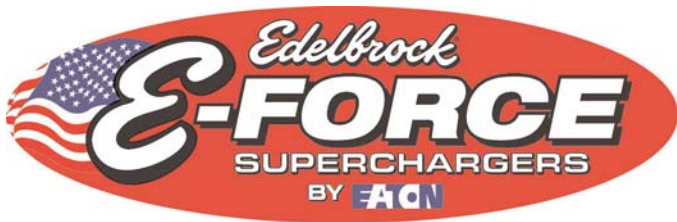

Edelbrock E-Force Supercharger System for the 2010-2012 Camaro SS

Installation Instructions

119. Apply o-ring lube to the upper seals of the supplied fuel injectors and install them into the supplied fuel rails so that the electrical connectors are oriented towards the rounded side of the rails.

120. Connect the supplied Fuel Rail Crossover line with the 90° fittings to the passenger side fuel rail then install the fuel rails by lining up the injectors with the provisions in the manifold and pushing them down until they are seated and the bolt holes in the rails line up with those in the supercharger. Route the crossover line below the hub snout and air inlet of the supercharger and over to the front of the driver side rail as you are installing the passenger side rail.

121. Install the supplied Fuel Rail Inlet between the fender fitting and fuel rail fitting on the passenger side.



122. Clip the Fuel Rail Crossover line onto the driver side fuel rail fitting.



123. Use a 5mm Allen tool to install the four M6 x 12mm fuel rail hold down bolts supplied in Bag #3.

124. Install the supplied Brake Booster to Manifold Hose onto the brake booster fitting and secure it with the 3/4" hose clamp supplied in Bag #2 then connect the other end of the brake booster hose to the fitting on the driver side of the supercharger air inlet and secure it with another hose clamp.

125. Reattach the fuel injector electrical connectors.

126. Use a small flat blade screwdriver to remove the wire loom covers from the back of the ignition coil brackets.

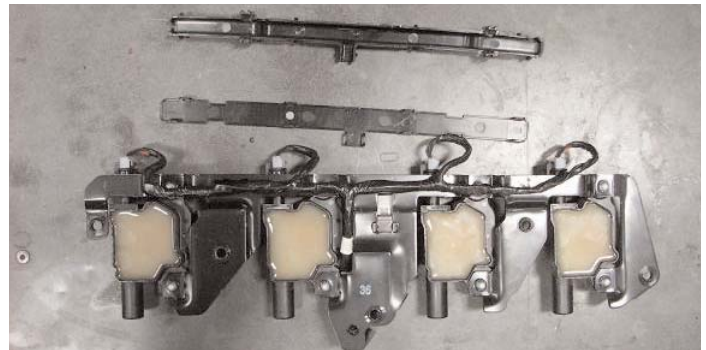

127. Install the supplied rubber grommets into the supplied coil cover brackets.



128. Use a 10mm socket to remove the two bolts holding the ignition coils for cylinders #2, #3, #6 & #7.

129. Locate the supplied coil cover brackets on top of the ignition coils then reinstall the ignition coil bolts.

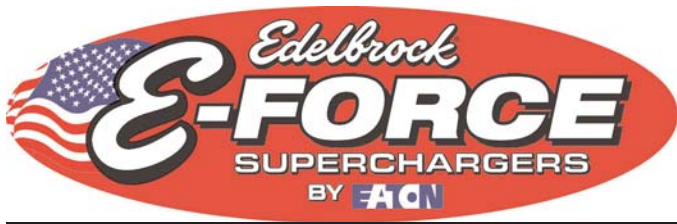

Edelbrock E-Force Supercharger System for the 2010-2012 Camaro SS

Installation Instructions

130. Use a 10mm wrench to remove the valve cover ball stud from the driver side cover.

131. Use a pair of pliers to remove the vacuum cap from the rear of the driver side valve cover.

132. Use a 10mm socket to reinstall the coil brackets using the five stock studs on each side then reconnect the ignition coil harness electrical connectors and the spark plug wires to the ignition coils.

133. Route the Driver Side PCV hose under the Brake Booster to Manifold Hose and behind the coil cover brackets to the vacuum fitting at the rear of the driver side valve cover and clip it into place.

134. Install the Passenger Side Manifold to Intercooler Reservoir Hose between the manifold and reservoir then secure the reservoir fitting with a hose clamp supplied in Bag #2. Refer to figure 4 on page 19.

135. Install Driver Side Manifold to Intercooler Reservoir Hose between the manifold and reservoir then secure the reservoir fitting with a hose clamp supplied in Bag #2. Refer to figure 4 on page 19.

136. Connect the Intercooler Hose Assembly to the rear facing driver side fitting and the side facing passenger side fitting. Push each hose end on until it clicks into place.



137. Use a 16mm wrench to install the coil cover standoffs on the valve covers.

138. Use a 10mm socket, the four stock bolts and the stock o-ring gasket to install the throttle body on the supercharger air inlet flange.

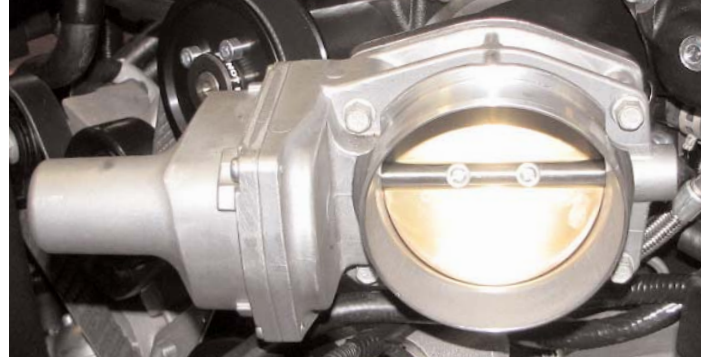

139. Route the TMAP wiring harness below the supercharger hub snout towards the driver side using care to secure it well away from the serpentine belt.

140. Connect the ETC extension harness to the stock ETC electrical connector and route the extension harness so that it will clear the serpentine belt and connect it to the ETC connector on the throttle body.



141. Use a T20 Torx bit to remove the MAF sensor from the stock air box cover and install it in the supplied air box cover. The arrow on the side of the sensor should point back towards the supercharger.

142. Replace the stock air filter with the one supplied.

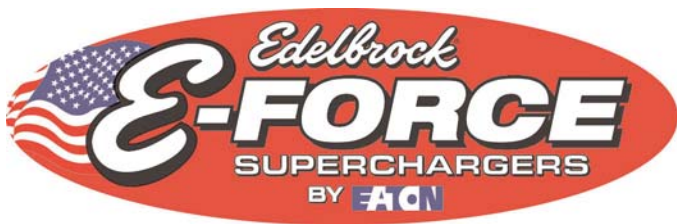

Edelbrock E-Force Supercharger System for the 2010-2012 Camaro SS

Installation Instructions

143. Slide the supplied worm clamps over each end of the supplied silicone tube then slide the tube onto the outlet of the supplied air box cover. Install the cover by sliding the tabs into the holes on the driver side of the air box while sliding the silicone tube onto the throttle body. Push down on the cover until the tabs snap into place.



144. Use a flathead screwdriver to tighten the worm clamps on each end of the silicone tube.

145. Connect the stock MAP & MAF sensor wiring harness connectors into the supplied TMAP wiring harness then connect the TMAP harness to the MAF sensor.

146. Use a 13mm socket to remove the nut from the power stud at the front of the fuse box. Slide the ring connector at the end of the orange wire on the relay harness over the power stud then reinstall the stock nut.



147. Install the relay on the tab on the passenger side of the fuse box and the fuse housing on the brace directly in front of the fuse box using the body pins supplied in Bag #2.

148. Route the intercooler water pump connector attached to the relay down to the water pump and plug it in.



149. Use a 10mm socket to remove the passenger side fender bolt, install the ground strap ring connector underneath it then reinstall the bolt.

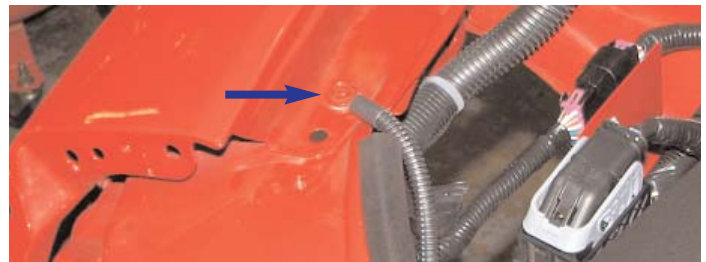

150. Disconnect the stock EVAP solenoid electrical connector and plug it into the color matched receptacle on the relay harness.

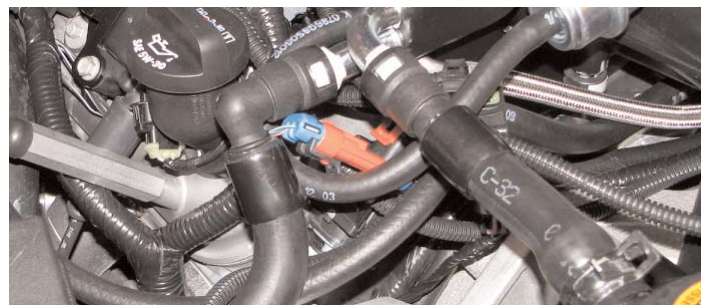

151. Clip the supplied EVAP solenoid electrical connector on the relay harness into the EVAP solenoid.

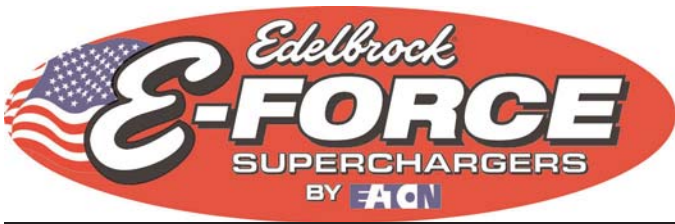

Edelbrock E-Force Supercharger System for the 2010-2012 Camaro SS

Installation Instructions

152. Carefully route the Passenger Side PCV Hose to the fitting on the underside of the silicone air inlet tube so as to avoid contact with the serpentine belt or any pulleys.



153. Use a 10mm deep socket to install the supplied ball studs into the new coil covers.

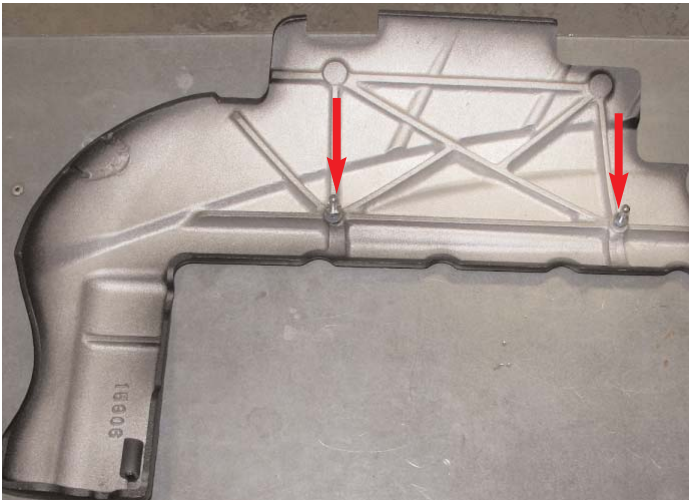

154. Install the grommet supplied in Bag #6 in the hole on the passenger side coil cover.

155. Slide the front fascia back into place and secure it by reinstalling the stock fasteners, including: six body pins and two bolts on top, three 10mm and two 7mm bolts inside the fascia on each side and two 10mm bolts on the underside.

156. Reconnect the fog light electrical connectors and the fascia wiring harness connector on the passenger side.

157. Use a 10mm socket to reconnect the positive battery terminal.

158. Use a 10mm socket to reconnect the negative battery terminal.

159. Remove intercooler reservoir cap and fill intercooler system with a 50/50 blend of water and coolant.

160. Refill the engine coolant system with a 50/50 blend of water and coolant.

161. Reinstall and secure the front inner fender wells with the stock fasteners.

162. Reinstall the front wheels and snug the lug nuts. Lower the vehicle to the ground then torque the lug nuts in a crossing pattern to 100 ft/lbs.

If you have yet to flash your ECU, then proceed with steps 163 - 176, otherwise disregard them.

163. It is recommended that you check the Edelbrock website (http://www.edelbrock.com/automotive_new/mc/superchargers/fuel_injected_soft-tech.shtml) to confirm that you have the latest calibration. Once you have found the latest tune on the site, power on the programmer, press the left arrow and select the Device Info option. Scroll down to Tune Version and compare that number to the one on the site. If they are different, download the new calibration with the supplied USB cable.

164. Turn the key to the On position, but do not start it.

165. Connect the PCM cable from the supplied downloader to the OBD-II connector located below the steering wheel in the passenger compartment.

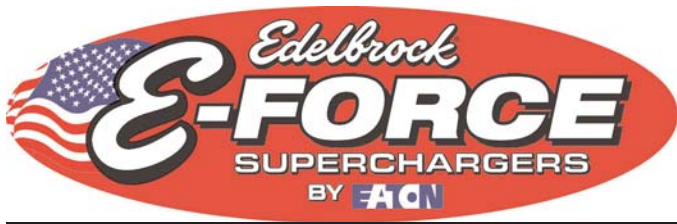

Edelbrock E-Force Supercharger System for the 2010-2012 Camaro SS

Installation Instructions

166. Use the directional pad to highlight the Program Vehicle option and press the Select button.

167. Use the directional pad to highlight the Preprogrammed Tune option and press the Select button.

168. Read disclaimer then press Select to continue.

169. Verify ignition is in the 'Key On' position but that the engine is not running then press Select.

170. Use directional pad to highlight your vehicle and transmission combination then press Select.

171. Use directional pad to highlight your vehicle and transmission combination then press Select, again.

172. Use directional pad to highlight Begin Program then press Select.

173. Vehicles equipped with a manual transmission will have three separate operations take place during this step, while vehicles with an automatic transmission will have five. Completion of each operation will cause the progress bar to reset to zero.

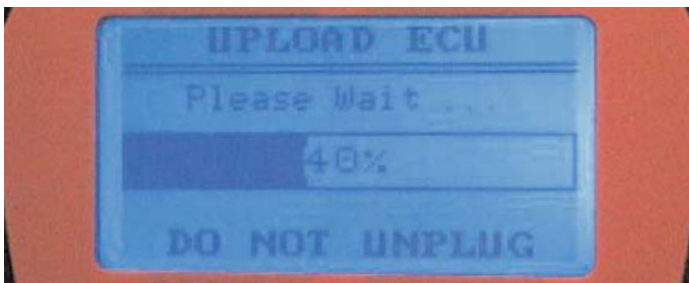

DO NOT unplug the programmer until prompted.

174. Turn the car off when prompted to do so by the handheld programmer.

175. Read parting message from programmer then press Select to continue.

176. Unplug the programmer cable from the OBD-II port.

177. Start the car and allow it to idle while closely inspecting the engine bay for any fuel or coolant leaks.

Repair any leaks before operating vehicle!

178. Remove the engine oil dipstick.

179. Lubricate the grommet on the passenger side coil cover then install it by sliding the grommet down and around the dipstick tube and pressing the ball studs into the bracket grommets.



180. Return the dipstick to the dipstick tube.

181. Install the driver side coil cover by sliding it into place and pressing the ball studs into bracket grommets.

Congratulations on the installation of your new Edelbrock E-Force Supercharger System. If you have any questions, please call our Technical Support hotline and one of our technicians will be happy to assist you.



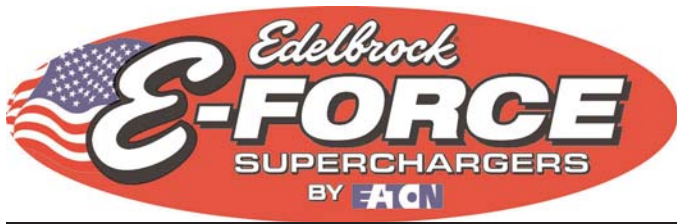

Edelbrock E-Force Supercharger System for the 2010-2012 Camaro SS

Installation Instructions

E-mail Edelbrock Your Stock Vehicle Calibration

In the rare occurrence that you encounter an error message that reads “Calibration not supported” during the test flash procedure on page 8, you will need to e-mail Edelbrock your stock vehicle calibration to Calibration@edelbrock.com. Otherwise, disregard this step.

- Begin by downloading the SCT device updater software to your computer; it can be downloaded from: <http://www.sctflash.com/software/SCTDeviceUpdater.exe>
- Put the car into Acc mode but do not start it.
- Connect the supplied PCM cable from the tuner to the OBD-II connector.
- Select PROGRAM VEHICLE, arrow over to UPLOAD STOCK, press SELECT and follow the prompts on the screen.
- If the upload fails, you will be asked to AUTO DETECT, press SELECT and follow the prompts on the screen. If the auto detect fail, then please contact Edelbrock Tech support @ 800-416-8628
- Once the stock calibration has loaded, disconnect the programmer from the OBD-II connector and connect it to your PC using the supplied USB cable.
- Open the SCT software and select the button on the lower left hand side that reads GET STOCK FILE FROM DEVICE. Follow the instructions on the screen.
- Once the download is complete e-mail your file to Calibration@edelbrock.com or call 1-800-416-8628 and our tech support staff will assist you in emailing the file. **NOTE:** The subject line of your email should be “file update needed”, The file will automatically be labeled using your VIN # followed by “.sul “ (XXXXXXXXXXXXX.sul)
- Once we have this file we can update the tune to work with your application, then we will e- mail you the custom tune which you may use until the release version is available. (This process can usually be completed within 1 to 2 business days)
- Download the new tune to the programmer using the directions received with the custom tune.
- Re-try the test flash procedure using the custom tune