



INSTALLATION INSTRUCTIONS

PLEASE study these instructions carefully before beginning this installation. Most installations can be accomplished with common tools and procedures. However, you should be familiar with and comfortable working on your vehicle. If you do not feel comfortable performing this installation, it is recommended to have the installation completed by a qualified mechanic. If you have any questions, please call our **Technical Hotline at: 1-800-416-8628**, 7:00 am - 5:00 pm, Pacific Standard Time, Monday through Friday or e-mail us at Edelbrock@Edelbrock.com.

IMPORTANT NOTE: Proper installation is the responsibility of the installer. Improper installation will void your warranty and may result in poor performance and engine or vehicle damage.

DESCRIPTION: Edelbrock Performer Series Carburetor.s have been calibrated, factory flow-tested, and preset. These instructions also apply to carburetors featuring our EnduraShine™ finish. Please read all instructions prior to installation. For “Theory of Operation” and “Tuning Procedures”, see the accompanying carburetor Owner’s Manual. These are non-emissions carburetors, check your local emissions laws.

ATTENTION: EDELBROCK CARBURETORS ARE NOT CALIBRATED FOR OR COMPATIBLE WITH ALCOHOL RACE FUEL OR E85 PUMP FUEL. USE OF ALCOHOL OR E85 IN YOUR EDELBROCK CARBURETOR WILL DAMAGE YOUR CARBURETOR AND VOID YOUR WARRANTY. THESE FUELS CAN ALSO DAMAGE OTHER FUEL SYSTEM COMPONENTS, UNLESS SPECIFICALLY DESIGNED FOR USE WITH ALCOHOL FUELS.

NOTE: Edelbrock Performer Series carburetors are not for computer-controlled applications. That includes some 1981 & later GM vehicles with Q-Jet carburetor and some 1981 & later Ford vehicles with automatic overdrive (AOD) transmissions.

KIT CONTENTS:

- 1 Installation Instruction Sheet
- 1 Owner’s Manual
- 1 Warranty Card
- 1 Square-Bore Base Gasket
- 1 Air Horn Gasket
- 1 Air Cleaner Stud
- 1 Red Choke Positive Wire (*Electric choke carburetors only*)
- 1 Black Choke Ground Wire (*Electric choke carburetors only*)
- 2 5/32” Vacuum Caps (*Except #1409 & 1410*)
- 1 5/32” Vacuum Tee (*Except #1409 & 1410*)
- 1 1/4 NPT Pipe Plug (*Except #1409 & 1410*)
- 1 Throttle Cable Ball-End Stud - 10-32 x .250” (*Except #1409 & 1410*)
- 1 10-32 Hex Nut (*Except #1409 & 1410*)
- 1 3/16” Internal Star Washer (*Except #1409 & 1410*)
- 4 5/16” SAE Flat Washers (*EnduraShine™ finish only*)

CHECK THE FOLLOWING BEFORE BEGINNING INSTALLATION

WARNING: WHEN WORKING AROUND GASOLINE, ALWAYS WORK IN A WELL VENTILATED AREA AND KEEP ALL OPEN FLAMES, SPARKS, AND OTHER SOURCES OF IGNITION AWAY FROM THE WORK AREA. FAILURE TO DO SO CAN RESULT IN A FIRE OR EXPLOSION.

- Replace fuel filter. Dirt found in carburetor voids warranty.
- Check and replace the air filter if necessary.
- Check PCV valve and replace if clogged.
- Check all hoses for leaks or cracks and replace if necessary.
- Check fuel pump for proper operation. Replace if necessary.
- Check the intake manifold and cylinder head gaskets for leaks and replace if necessary.
- Check the ignition system: clean and gap or replace spark plugs, plug wires, and adjust ignition timing to proper specifications.

PARTS AND TOOLS RECOMMENDED FOR INSTALLATION

- New fuel filter (Edelbrock #8135 or equivalent)
- Chrome Steel Fuel Line Kit #8134 includes fuel filter.
- Banjo Fuel Fitting #8089 (if required for air cleaner clearance).
- New air cleaner (Edelbrock #1221 or #4221 recommended). If stock or other air cleaner is to be used, check fit on carburetor before installation to determine if Edelbrock Air Cleaner Spacer #8092 is required.
- Choke cable kit (manual choke only) or electrical connectors (electric choke only).
- Throttle, transmission, and cruise control bracket #8031, 8036, or 8030 (chrome) for 1972-1978 small-block Chevrolet. Other applications may require modification to original bracket.
- Divided Square-Bore Heat Insulator Gasket #9266 for dual-plane (stock or Performer series) manifolds. May be used in place of Square-Bore Adapter Plate #2732 on some Edelbrock manifolds.
- Throttle Linkage Kits for Ford or Chrysler applications (**See Carburetor PREPARATION, Step #1**)
- Carburetor adapter, if carburetor is to be installed on other than square-bore intake manifold. See steps #4 and #5 for specific part numbers. Do not use a 4-bbl to 2-bbl adapter (Use Edelbrock carbs on intake manifolds designed for 4-bbl carburetors only!)
- Universal Throttle Return Spring Kit #8005 (if original return spring cannot be reused).
- Sockets/wrenches/tubing wrenches
- Pliers
- Hacksaw and/or tubing cutter
- Screwdrivers & Torx driver (for electric choke models)
- Wire crimpers (for electric choke models)
- Test Meter or Test Light (for electric choke models)

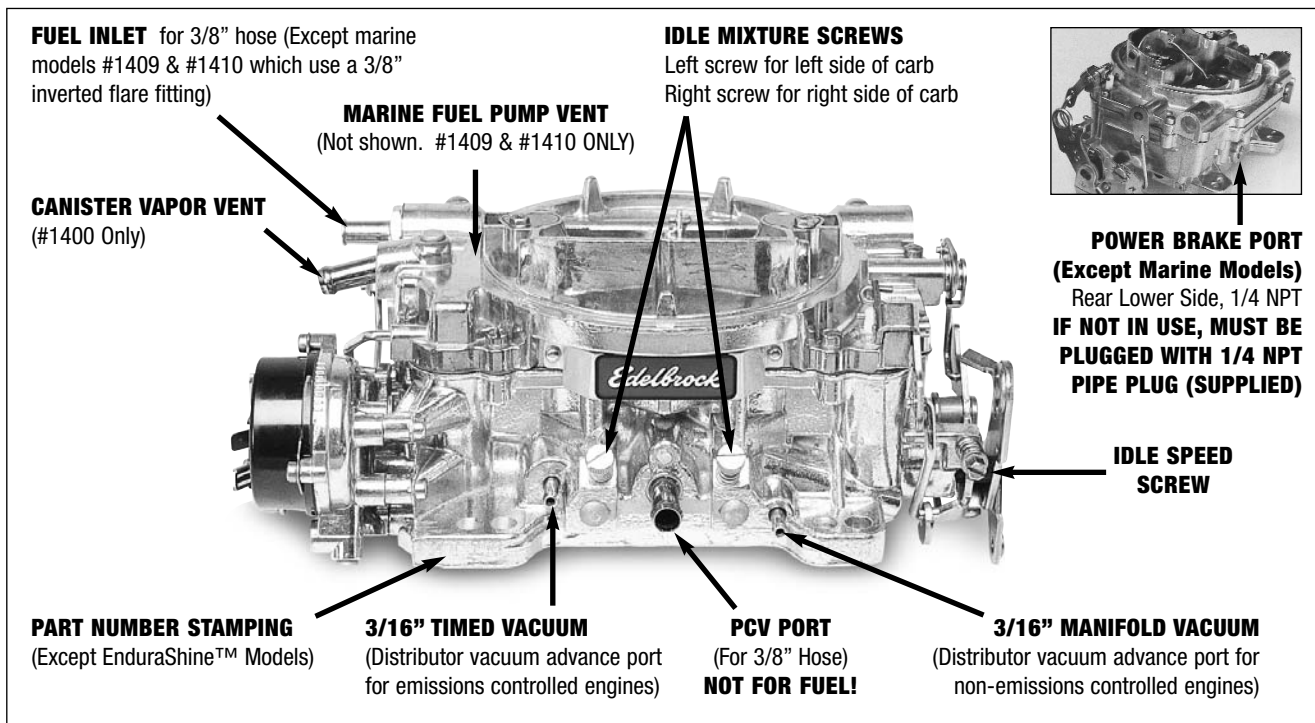
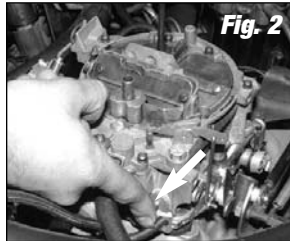

Figure 1 - Fittings and Vacuum Port Locations

INSTALLATION PROCEDURE

BEFORE REMOVING OLD CARBURETOR

1. **Determine if the distributor vacuum port is timed (no vacuum at idle) or full (vacuum present at idle).** With the engine at operating temperature and idling, pull the vacuum advance hose off of the carburetor and “feel” for vacuum by putting your finger on the vacuum port (See Fig. 2). If your distributor has timed vacuum advance, you will hook the vacuum hose from the distributor to the passenger side vacuum port on the new carburetor. If it has full vacuum advance, it will be hooked up to the driver side port.



2. **The stock steel fuel line must be converted** to fuel resistant rubber hose. The stock steel line will not connect to the Performer Series Carburetor. Use Edelbrock Universal Fuel Line Kit #8135. This kit contains a filter, neoprene hose, and fittings to adapt to 5/16” or 3/8” stock steel fuel lines (See Fig. 3).

NOTE: After cutting the steel line, remove sharp edges and clean out any chips.

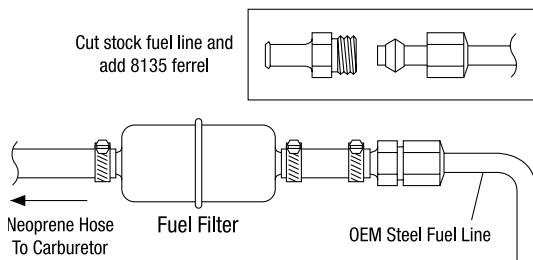

Fig. 3 - Fuel Line Kit #8135 Installed on Stock Steel Line

- 3. **Always use a new fuel filter.** Failure to do so will void your warranty.
- 4. **You must use Edelbrock Adapter #2696 or Adapter & Fuel Line Kit #2697** when installing a Performer Series carburetor on a General Motors Quadrajet or Chrysler Thermoquad intake manifold. #2697 includes adapter #2696 and fuel line kit #8135. **Do not use an open adapter! (See Fig. 4)**



Fig. 4

- 5. **You must use Edelbrock Adapter #2732** when installing a Performer Series carburetor on certain Edelbrock intake manifolds. In those applications, install the adapter as shown (See Fig. 5).

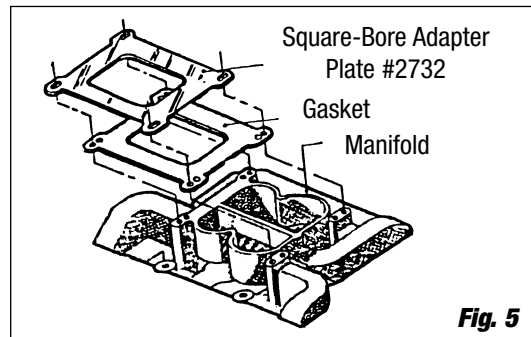

Fig. 5

6. **Do not use more than 6.5 PSI fuel pressure.** Excessive fuel pressure may cause flooding. If your fuel pressure is too high, install an adjustable pressure regulator, such as Edelbrock #8190.
7. It may be necessary to re-route the fuel line to prevent interference with the air cleaner. Test fit your air cleaner on your new carburetor before you begin installation. Look for areas of interference such as the choke housing, fuel inlet fitting, and fuel line.

PERFORMER SERIES CARBURETOR INSPECTION

1. Check for possible damage to the carburetor.
2. Make sure all throttle linkages operate freely.
3. Ensure that all fuel inlet and vacuum ports are free from packing material.

CARBURETOR REMOVAL

1. Prior to removal, make sure that the engine is cool.
2. Disconnect the negative battery cable from the battery.
3. Remove air cleaner. Be sure to carefully disconnect any hoses from the air cleaner and note their location for reinstallation. You may want to mark them with masking tape for easy reference.
4. Disconnect throttle linkage, kickdown linkage (certain automatic transmission applications only), cruise control (if equipped) and any return springs if present.

NOTE: Check carefully for the precise location of all these linkages and return springs. You may want to mark them with masking tape for easy reference.

5. Disconnect all wires, tubes, and hoses from carburetor and note their locations.

NOTE: There should be a maximum of one wire to the electric choke and one to the idle compensator solenoid (if equipped with A/C). Any other electrical wiring attached to your carburetor indicates a computer controlled engine. Edelbrock carburetors will not function correctly on computer controlled applications.

6. Disconnect the heater tube from the choke housing (if so equipped). Edelbrock carburetors do not use the hot-air-style choke, so this tube may be left disconnected with no problems. If you would like to cover this opening on a stock manifold, you may be able to use the appropriate Edelbrock Choke Adapter Plate: #8901 for small-block Chevrolets; #8961 for big-block Chevrolets; #8951 for Oldsmobile V8s; #8971 for 351-M/400 Fords; #8981 for 351-W Fords.
7. Carefully remove the fuel line from the carburetor. **TAKE EXTREME CARE NOT TO SPILL ANY EXCESS FUEL.** Place a rag underneath the fuel line to absorb any spillage that may occur. Certain models require two wrenches to remove the fuel line; one to hold the fitting on the carburetor and the second to turn the fitting on the fuel line. Use a tubing wrench to avoid rounding the tube fitting nut.
8. Remove mounting nuts or bolts and washers. Be sure to put them where they won't fall into the intake manifold upon carburetor removal.

9. Remove carburetor, being careful not to spill any dirt into the intake manifold. Immediately place a clean rag into the intake manifold to keep foreign objects out.
10. Remove old mounting gasket and thoroughly clean mounting surface. Compare old carb gasket to the gasket included with your Edelbrock carburetor. If there is a difference in bolt pattern or bore spacing, an adapter will be required (see "Before Removing Old Carburetor", steps #4 & #5).

CARBURETOR PREPARATION

1. Compare the throttle arm of your new carburetor with the old one to be sure that all required linkages will hook up. Install the proper throttle and transmission linkage for your particular application. Throttle stud is removable and

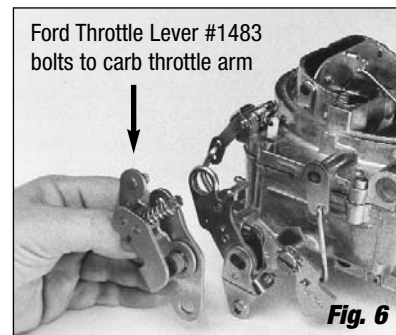

Fig. 6

- must be installed in the proper location. Chrysler vehicles with automatic transmission will require Throttle Lever Kit #1481. Ford vehicles with automatic transmission and cable linkage will require Throttle Lever Kit #1483 (See Fig. 6) and Throttle Cable Plate Kit #1490 (for 289-302), #1491 (for 351-W), #1493 (for 351-C & 351-M/400), or #1495 (for 429/460).
2. Check and prepare carburetor for proper vacuum fitting installation (EGR, power brakes, PCV, distributor, transmission, etc.), using the supplied vacuum caps, "T" and hose when applicable. **If vacuum port at rear of carb is not used, plug with the 1/4 NPT pipe plug supplied (Except marine models, port is not drilled).**
3. On electric choke models (See Fig. 7), remove one choke housing retaining screw and install eyelet end of choke ground wire (black) to the choke housing, and reinstall the screw. Connect clip end of choke ground wire to negative (-) spade terminal on choke housing.

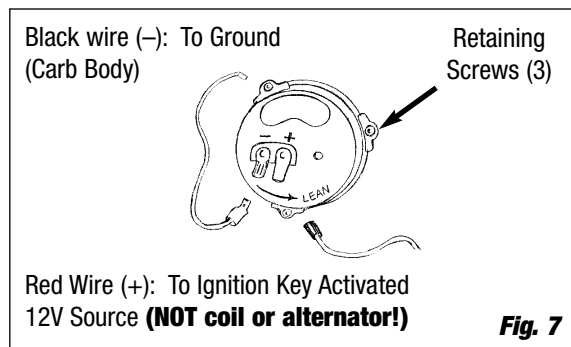

Fig. 7

CARBURETOR INSTALLATION

1. Remove rag from intake manifold and install new studs, mounting gasket and adapters (where applicable).
NOTE: Do not use any cement, glue, or RTV sealant on gasket.
2. Carefully place new carburetor on gasket.

- Replace all mounting nuts and washers. EnduraShine™ finish carburetors should use the supplied 5/16" flat washers under any other washers used. Hand tighten with a short box-end wrench, alternating between diagonally opposed nuts.

CAUTION: Overtightening may break carb base and void your warranty.

- Connect all throttle and transmission linkages and throttle return springs. You may have to cut, bend or modify your stock throttle cable brackets to fit the new carburetor, or use GM #352279 (See Fig. 8). 1972-78 small-block Chevrolets may use Edelbrock Throttle, Transmission, and Cruise Control bracket #8031, #8036, or #8030 (chrome).



IMPORTANT NOTE: With engine OFF, make sure that there is no interference when opening and closing the throttle. Be sure there is no binding or hanging up between idle and wide open throttle, as this could cause the throttle to stick open, resulting in loss of engine speed control.

- Manual choke: Connect manual choke cable to the choke lever cable mounting bracket (See Fig. 9). Electric choke: Connect the red choke wire to a 12

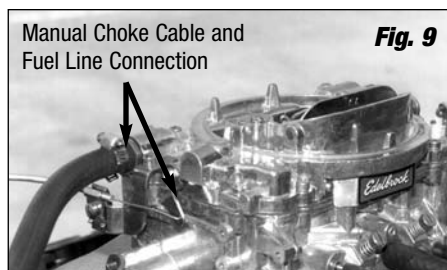

volt positive (+) source that is activated by the ignition switch (**Not the coil or alternator; see Fig. 7).**

NOTE: If manual choke is not connected (secondary carb of dual-quad setup, for example) then the choke blade must be fixed open. To lock open, use a stiff piece of wire between the choke lever and the mounting bracket. Fold the wire to double its thickness about one inch from one end. Insert the wire in the choke lever, hold choke blade in the wide-open position, and tighten the cable clamp on the folded end of the wire.

- Connect all vacuum hoses to their proper location on the carburetor (See Fig. 1). Replace hoses that appear brittle or cracked to prevent vacuum leaks.
- Connect fuel line to carburetor. Avoid contact with any sharp edges or areas of extreme heat.

NOTE: Some late model Ford 460 engines are equipped with hot fuel bypass units. It is necessary to replace the stock unit with Ford #E3TZ9N176B (with blue dot) which has a .040" orifice.

- Edelbrock idle compensator #8059 may be installed to raise idle speed during air conditioning compressor operation.
- Install new air horn gasket and air cleaner stud (supplied). Install air cleaner, making sure it does not contact the carburetor linkage or fuel line, and has proper hood clearance. We recommend Edelbrock Pro-Flo chrome air cleaner #1221, which is a 14" diameter, open element air cleaner that is designed to fit all Edelbrock Performer Series carburetors. Extremely low profile air cleaners will not fit electric choke carburetors without air cleaner spacer #8092 (due to choke and fuel line interference) but will fit manual choke carburetors when used with 90° banjo fuel inlet fitting #8089 (See Fig. 10).



- Mark air cleaner stud for proper length, remove from carburetor, and cut with a hacksaw. Deburr stud and reinstall it in the carburetor, along with the air cleaner (See Fig. 11).



- Recheck all linkage for smooth throttle operation.
- Reconnect the negative battery cable from the battery.
- Start engine and check for fuel or vacuum leaks. With engine at normal operating temperature and the choke fully open, set idle speed and mixture screws (See Carburetor Owner's Manual).

CAUTION: Be alert to carburetor flooding. Flooding can be caused by dirt, small particles of hose cuttings, floats and inlet needles which have settled during shipping, etc. When the fuel pump is turned on or when the engine is first started, watch closely for signs of flooding. If flooding occurs, turn engine off immediately and lightly tap on the side of the carburetor that is flooding, in the rear needle and seat area with a rawhide mallet, or wooden handle of a hammer. Start engine and see if flooding continues. If so, refer to your owner's manual.

WARNING: NEVER POUR FUEL DIRECTLY DOWN THE CARBURETOR WHEN ATTEMPTING TO START THE ENGINE! THIS MAY CAUSE A BACKFIRE AND POSSIBLE ENGINE COMPARTMENT FIRE, RESULTING IN ENGINE OR VEHICLE DAMAGE, PERSONAL INJURY, AND/OR DEATH.

**Edelbrock Corporation • 2700 California St. • Torrance, CA 90503
Tech-Line: 1-800-416-8628 • E-Mail: Edelbrock@Edelbrock.com**