

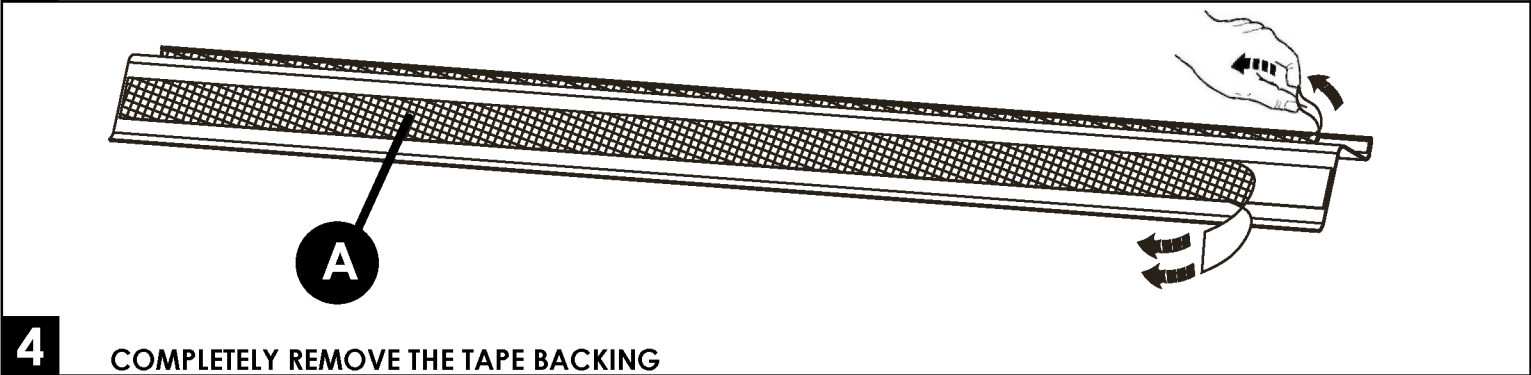

JEEP WRANGLER DOOR ENTRY SILLS

- A. DRIVER FRONT DOORSILL
- B. PASSENGER FRONT DOORSILL
- C. DRIVER REAR DOORSILL
- D. PASSENGER REAR DOORSILL

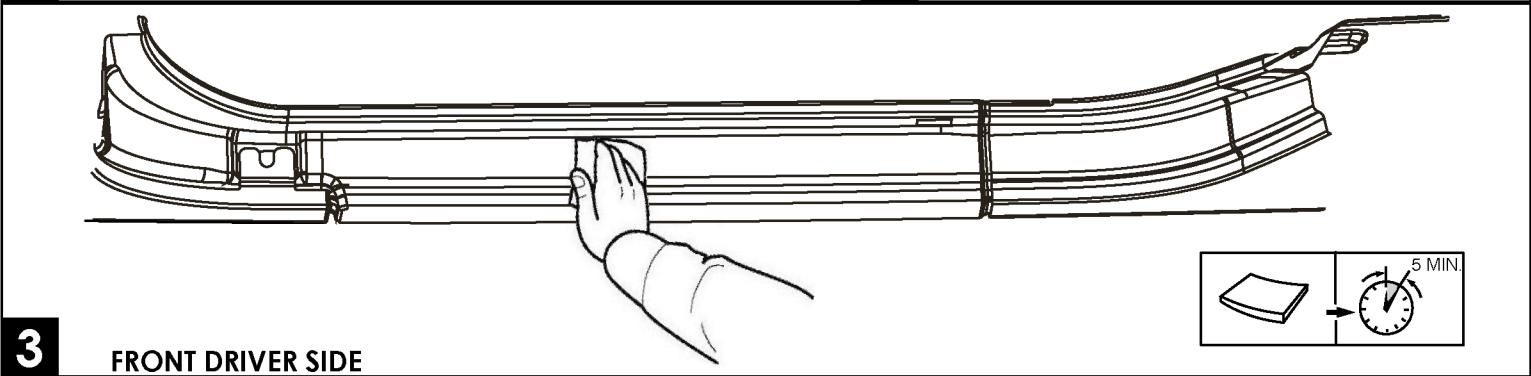

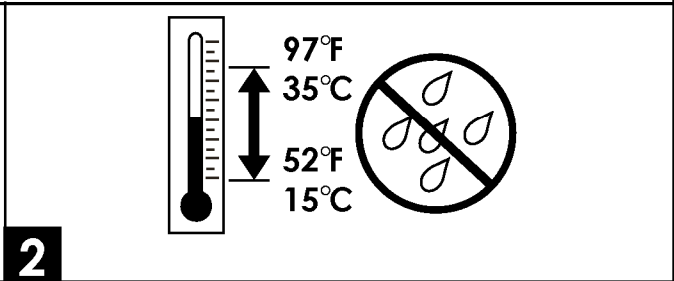
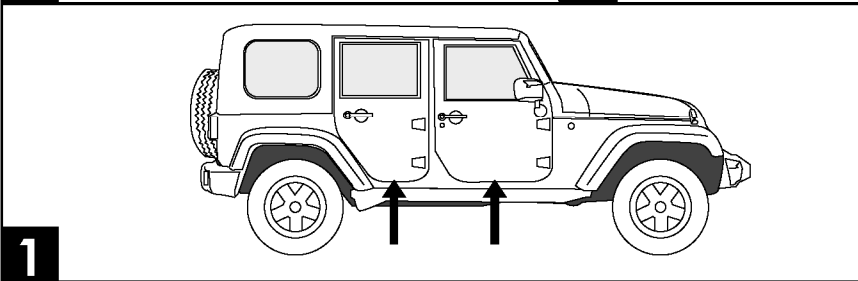
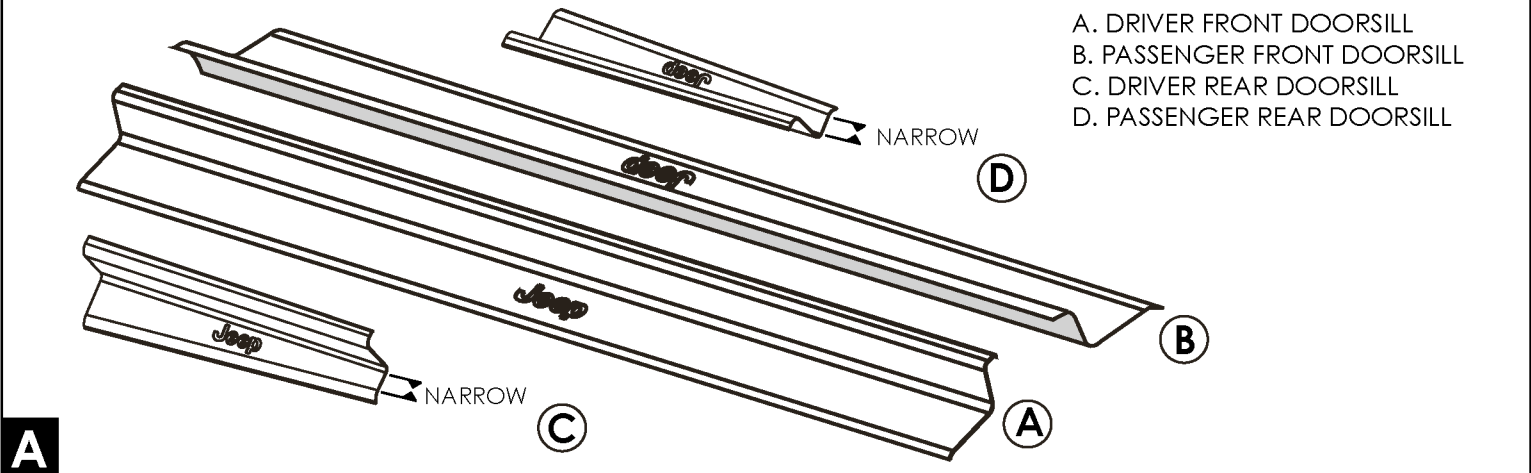
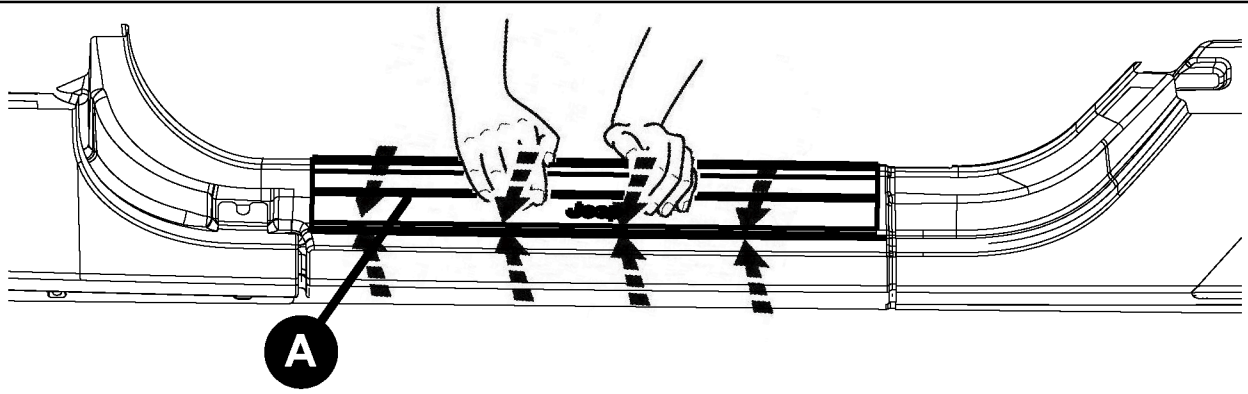

5 REPEAT STEPS 3-5 FOR OTHER SIDE (w/PART 'B')

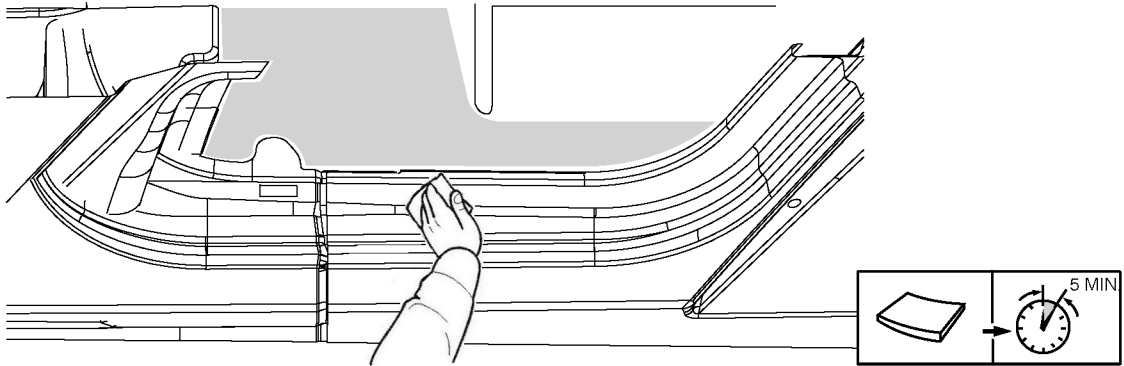

6 REAR DRIVER SIDE

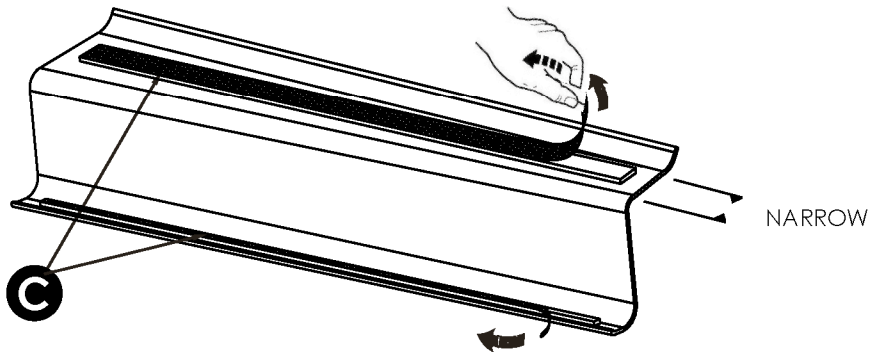

7 COMPLETELY REMOVE THE TAPE BACKING

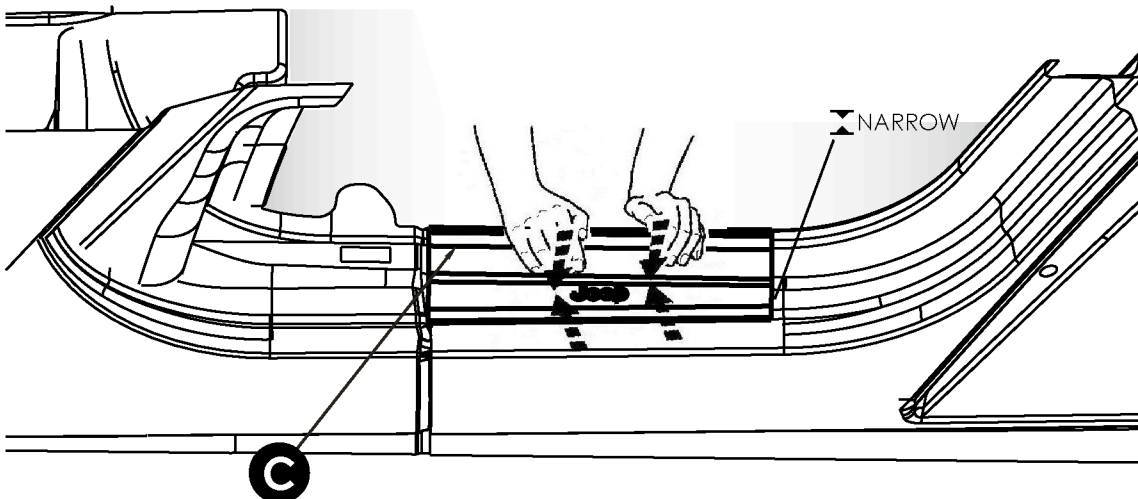

8 REPEAT STEPS 7-8 FOR OTHER SIDE (w/PART 'D')