

Hellwig PRODUCTS.com

559-734-7451 800-367-5480 FAX 559-734-7460

INSTALLATION INSTRUCTIONS

Rear Stabilizer Bar 6907

Mopar A-Body

Thank you for purchasing a quality Hellwig Product.

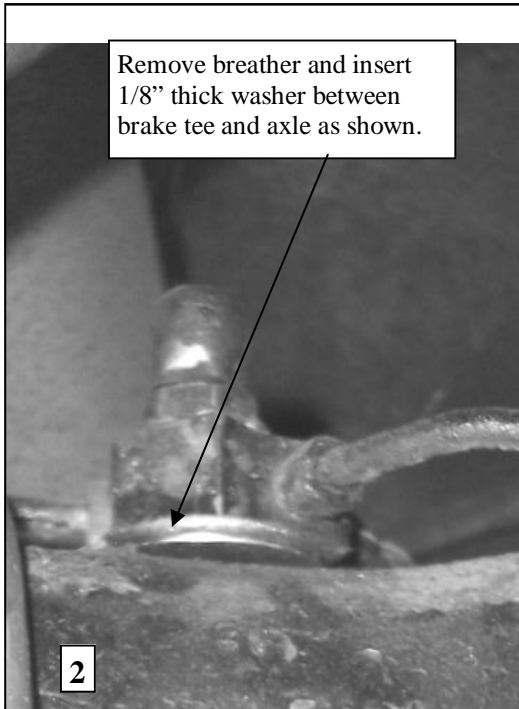
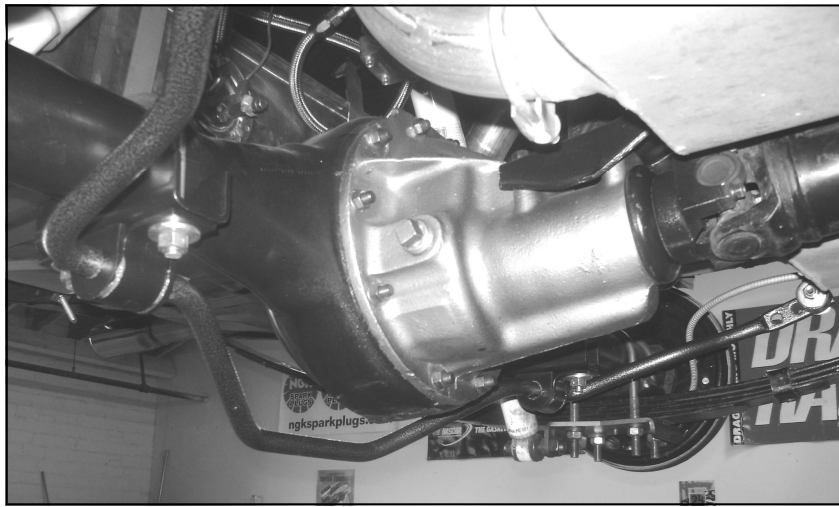

Hellwig PRODUCTS.com

559-734-7451 800-367-5480 FAX 559-734-7460

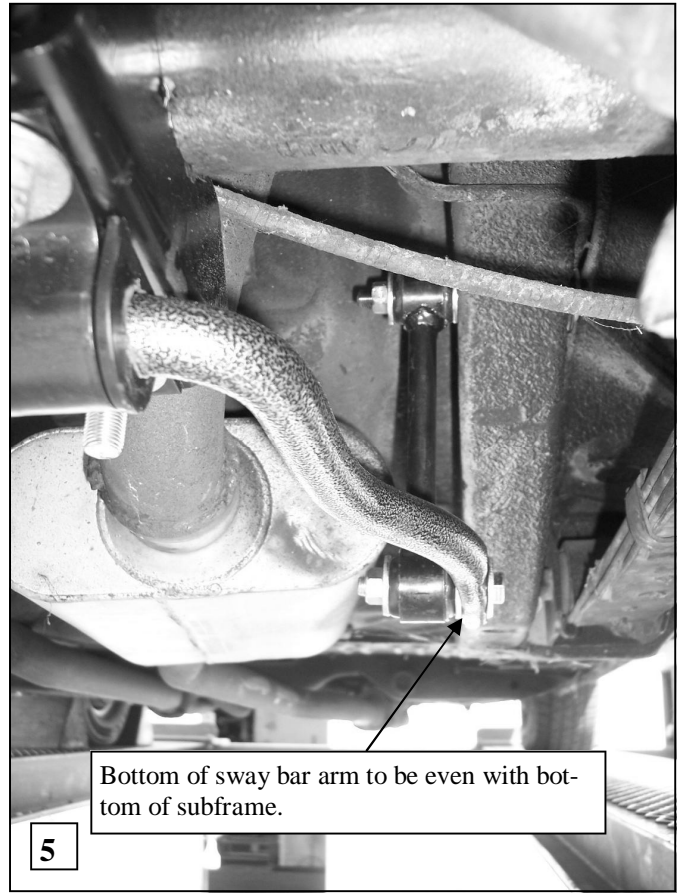

TORQUE TABLE

Bolt Size 3/8"— 35 ft lbs * Bolt Size 7/16"— 45 ft lbs* Bolt Size 1/2"—75 ft lbs *Bolt Size 9/16"— 90 ft lbs

SAFETY: BEFORE BEGINNING INSTALLATION BE SURE TO SET THE PARKING BRAKE AND CHOCK THE WHEELS.

NOTE: TO EASE INSTALLATION AND PROPERLY ADJUST THE BAR, THE WEIGHT OF THE VEHICLE MUST BE ON THE SUSPENSION AS IF DRIVING DOWN THE ROAD. DO NOT RAISE THE VEHICLE BY THE FRAME.

NOTE: THIS KIT REQUIRES DRILLING THE FRAME RAIL AND POSSIBLE RELOCATION OF FUEL AND BRAKE LINES. INSTALLER MUST ENSURE THAT THE SWAY BAR KIT WILL NOT INTERFERE WITH ANY FUEL OR BRAKE LINES OR HOSES.

IMPORTANT NOTE: SWAY BAR END LINKS MUST BE ATTACHED ON OUTER HOLE PRIOR TO INITIAL USE. SEE PHOTO 11.

1. Lubricate the D shaped bushings and place them onto the straight areas of the bar on each side of the center hump as close to the outside bend as possible.
2. Remove the breather vent bolt from axle. Place spacer washer under brake line tee and re attach vent bolt as shown in PHOTO 2. This will provide adequate room for the axle u-bolts to be placed under the brake lines.
3. Hold bar up to the axle and locate the position on the axle tubes to mount the u-bolts. Orient sway bar with center hump pointing down. **Be sure to put the U-Bolts Under Any Brake Lines, Wires or Hoses on the Axle to Avoid Any Possible Damage.** The threads of the U-Bolts will point down. See

Hellwig PRODUCTS.com

559-734-7451 800-367-5480 FAX 559-734-7460

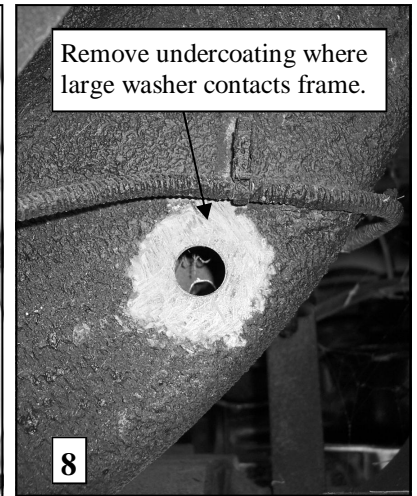
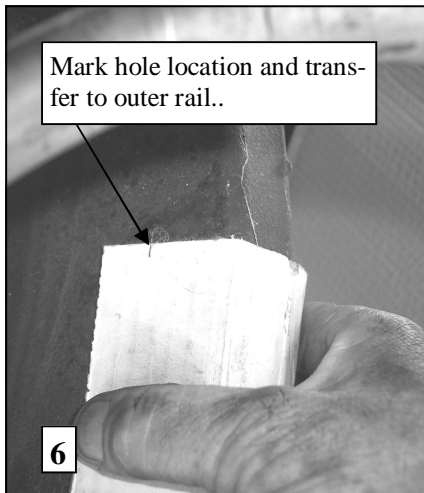

4. Place the saddle brackets onto the U-Bolts on the axle tubes. Place the U-Plates over the D shaped bushings on the bar and attach the bar to the U-Bolts and saddle brackets with the flat washers and nuts provided. **LEAVE LOOSE AT THIS TIME** to allow for adjustment later. See PHOTO 3.
6. Position sway bar on axle so that it clears all frame mounted components including fuel tanks, brake lines, fuel lines, etc. Sway bar can be rotated back and forth on axle to maximize clearance.
7. Assemble end links by inserting hourglass bushings and then inner sleeves into end link loops. **Fully lubricate bushings and sleeves before installation.**
8. Attach end links to the center hole of the sway bar as shown in photo 4 using a 7/16-20 X 2-3/4” bolt and washers. Align end links for best fit as shown in PHOTO 4. **IMPORTANT NOTE – Center hole position is only for determining hole location. The end link must be moved to the outer hole prior to initial use.**
9. The end links should be located as shown in PHOTO 4 and 5 so that the arms of the sway bar are even with the bottom of the subframe. When satisfied with location of sway bar and end links, mark hole location for end links on subframe.
10. Prepare to jack up vehicle by placing wheel chocks on the front wheels. After the rear of the vehicle has been raised, **support frame on jack stands** and remove rear wheels. **Make sure end link hole location has been marked before raising vehicle as hole location must be determined with the full weight of the vehicle on the suspension.**
11. Transfer hole location to outer edge of subframe rail. A piece of card board can be used by marking the location of the hole on the cardboard and transferring the location to the outer rail. Drawing a line on the subframe square to the subframe rails will keep the hole location square. See PHOTO 6,7,&8.
12. **Review end link mounting detail before drilling holes. BEFORE DRILLING ANY HOLES IN THE RAIL—RELOCATE AND PROTECT ANY FUEL OR BRAKE LINES THAT MAY INTERFERE WITH THE DRILL BIT OR SWAY BAR INSTALLATION.**
13. Drill a 15/32 (.468) hole through **BOTH** walls of the subframe. Make sure holes are square to one another when drilling holes. It is easiest to drill through the outer wall first and use a transfer punch to mark location on inner wall of subframe.
14. Drill an 11/16 (.688) hole through **OUTER** wall of subframe **ONLY**. See photo 7. A step drill works well for this application. Do not use a hole saw as the hole must be a close fit to the spacer tube.

Hellwig PRODUCTS.com

559-734-7451 800-367-5480 FAX 559-734-7460

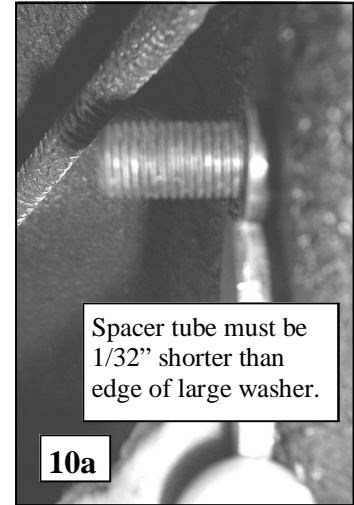
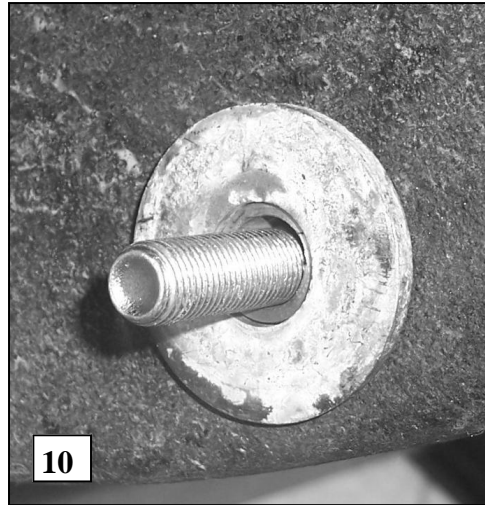
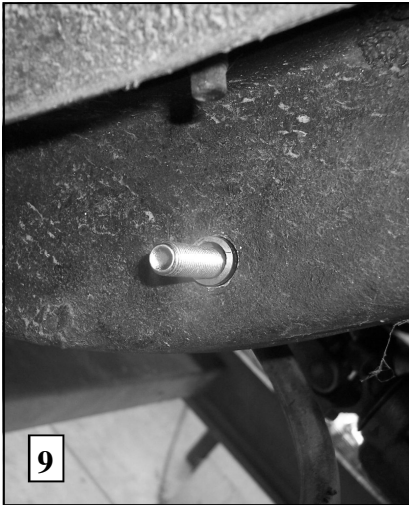

15. Insert 7/16 X 5" bolt through driver's side rail as shown in PHOTO 9. Insert 7/16 X 5" bolt in same manner through passenger side rail. Insert 2-3/4" long spacer sleeve into hole so that it is flush with the inboard wall of subframe.
16. For severe duty it is recommended that the spacer tube be welded to the outer subframe wall. If the spacer is to be welded, review severe service end link detail on page 4 and skip to line 19. If any welding is to be done, the installer must ensure that all hazards (fuel, electrical, etc) are eliminated and that fuel tanks, fuel lines, brake lines, wiring, etc. are not affected by the welding operation.

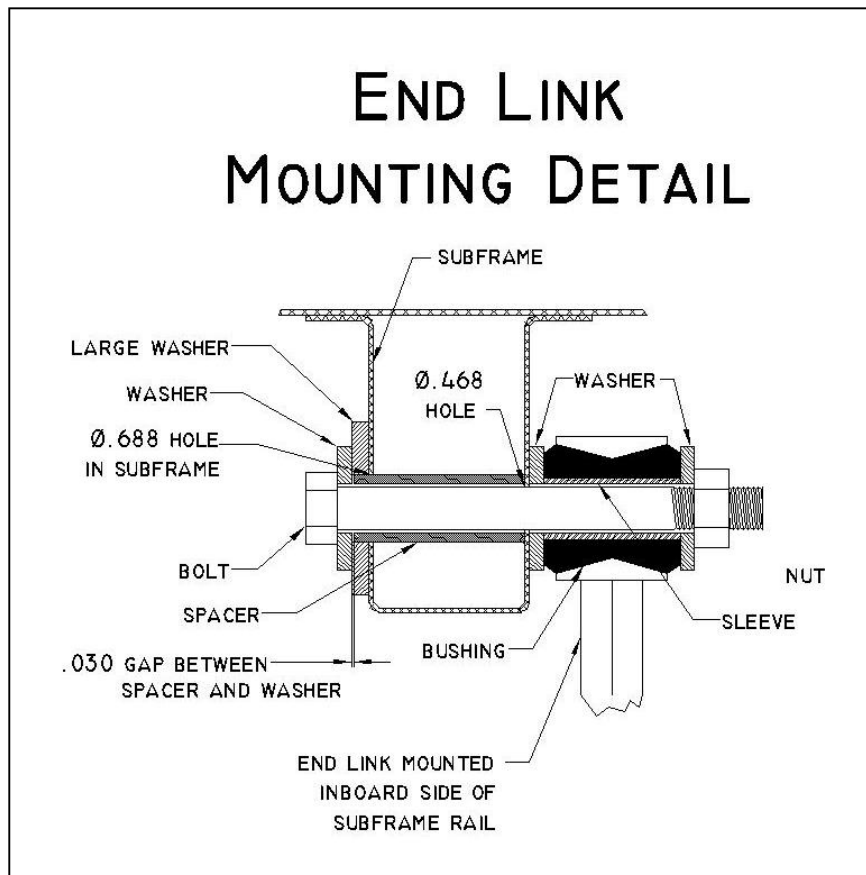

Hellwig PRODUCTS.com

559-734-7451 800-367-5480 FAX 559-734-7460

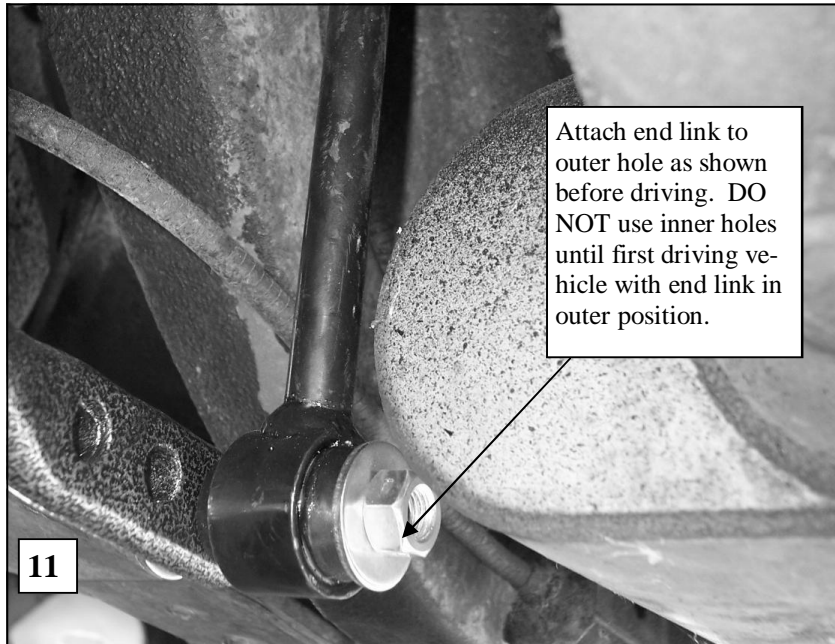

17. The spacer tube is extra long to allow for subframe variation and subframe repair caps. If spacer tube is not welded to outer wall, it must be fitted to the vehicle as described in step 18.
18. Review end link detail and install Large washer over spacer tube. Check that spacer tube is at least 1/32" below the surface of large washer. Failure to do this will result in insufficient preload and noise. Cut, file or grind end of spacer tube to achieve proper length. SEE PHOTO 10.& 10a.
19. Install Large washer over spacer tube and check that spacer tube is at least 1/32" below the surface of large washer. Failure to do this will result in insufficient preload and noise. File or grind end of spacer tube to achieve proper length. SEE PHOTO 10.& 10a. Remove bolt and spacer and attach end link to subframe as shown in detail and PHOTO 11. Applications with welded spacer do not require the washers on the outboard side of subframe. Torque end link bolts to 35-40 ft-lb.
20. Replace rear wheels and torque lug nuts to factory specification. Lower vehicle so that the full weight of the vehicle is on the suspension.
21. Tighten axle u-bolts to 30-35 ft-lb.
22. **Bounce the vehicle checking for clearance on all under carriage components: fuel tank, shocks, exhaust, differential, brake and fuel lines, etc.** Test drive the vehicle and recheck all clearances and the installation alignment. Adjust as needed. Re-check your installation after one week of driving and periodically on a regular basis.
23. **The sway bar has three end link mounting holes. The end link MUST be mounted on the outer hole for initial use. SEE PHOTO 11. For a firmer setting, use the inner holes. You must use the outer mounting hole as shown in photo 11 until you are accustomed to the vehicles new handling characteristics. After driving vehicle, a firmer setting may be selected if desired. It is recommended that the outer hole be used for street driving.**

ATTENTION INSTALLER: BE SURE THAT THE CUSTOMER RECEIVES THIS INSTRUCTION SHEET, ALL IMPORTANT NOTE CARDS AND THE WARRANTY FORM

Hellwig PRODUCTS.com

559-734-7451 800-367-5480 FAX 559-734-7460

END LINK MOUNTING DETAIL SEVERE SERVICE

