



INSTALLATION INSTRUCTIONS FOR
2003-UP Toyota Tundra
TOOLS REQUIRED FOR INSTALLATION

- 10 mm Socket / Ratchet
- Utility Knife
- Phillips stubby screw driver

FLARE INSTALLATION PROCEDURES

Step 1: Painting Flares

Dupont or equivalent paint system

(A) Preparation:

1. Wash part thoroughly with soap and warm water to release water-soluble mold release.
2. Wash part again with DuPont 2319S Plastics Prep.
3. Scuff all areas to be painted thoroughly with red Scotch Brite or equivalent grade scuff pad.
4. Wash part again prior to painting with 2319S to remove any remaining mold release.

Note: To test if part is thoroughly clean, pour a capful of 2319S over the cleaned surface. If the liquid flows smoothly over the surface, the part is cleaned properly. If the liquid shows evidence of fisheyes or distortion as if you poured water over an oily surface, the part needs to be cleaned more thoroughly.

(B) Adhesion Promoter:

1. Apply one medium wet coat of DuPont 2322S and allow to flash for a minimum of 15 minutes but no more than 1 hour.
2. If the 2322S has dried for more than 1 hour, apply another medium coat and allow 15 minutes flash.

(C) Basecoat Application:

1. Apply ChromaBase™ Color to achieve coverage, usually 2 to 4 coats depending on color.
2. Allow 5 to 10 minutes flash time between coats.
3. After the last coat of color allow 15 to 30 minutes flash time before applying clear coat.

(D) Clear coat:

- Apply any ChromaClear™ per labeled directions.
- 2 to 3 coats 7500S or 7600S.
 - 2 coats only if using 7800S.

(E) **Single Stage Application:** When Applicable.

- Chroma One™ Acrylic Urethane 2 to 3 coats per labeled directions.
- Imron® Polyurethane Enamel 2 to 3 coats per labeled directions.

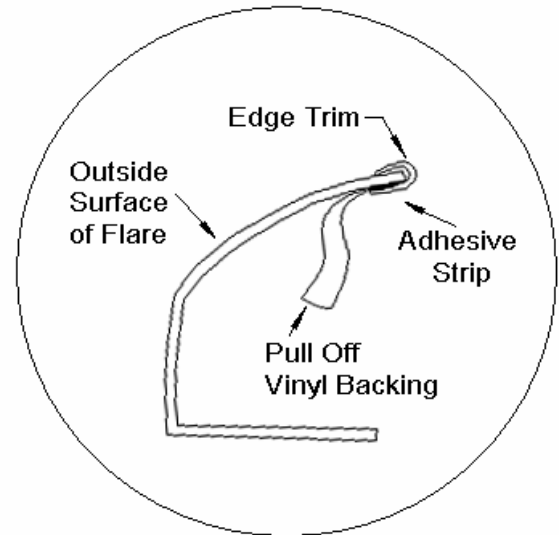

FIGURE 1

Step 2: Applying Edge Trim

Note: Flare and Edge Trim must be above 55° F for complete bonding of tape.

- (A) Lightly sand any over spray on backside of flare where tape is to be applied. Clean application area with a 50/50 alcohol/water solution, and dry with a clean cloth.
- (B) Peel two to three inches of red vinyl backing away from edge trim tape. Applying the adhesive side of the edge trim to the inner side of the flare, affix the edge trim to the top edge of the flare (the portion that comes in contact with the side of the vehicle). Press edge trim into place along the top edge of the flare in one-foot increments, pulling red vinyl backing free as you continue to work your way around the top edge of the flare.
See FIGURE 1.
- (C) Repeat Step 2A for remaining flares.

Step 3: Attaching Front Flares

- (A) Remove and save 3 screws from inside lip of wheel well. Remove and save 2 outer screws securing mud flap to vehicle. If vehicle has no chrome strips, insert the supplied plastic grommets into holes in wheel well lip. **See Figure 3.**
- (B) Attach mounting brackets to front flare through top three holes in flare and 1/4" hole in bracket with Tuf-Lok® fasteners. **See Figure 2 & 4.**
- (C) Secure flare to fender using the screws removed in step 3A and the screws supplied in the kit. **See Figure 3.** Leave the front most of the top three screws loose, to allow alignment with the bumper piece. **(See Step 4, (K) for tightening.)**

Step 4: Attaching the Bumper Piece

- (A) Hold bumper piece in place on bumper, aligning it with the flare, the top of the bumper, and the inside lip of bumper. **See Figure 3 and 6.**
- (B) Mark four holes using the bumper piece as a guide and remove bumper piece.
- (C) Drill three 1/4" holes in bumper lip for the speed screws. **See Figure 3 and 6.**
- (D) Slide three supplied speed clips on bumper lip over the drilled holes. The threaded side should be on back side of lip. **See Figure 7.**
- (E) Apply a black tab to marked location on bumper, keeping the edge of tab even with the bumper lip. **See Figure 8.**

- (F) Slide a silver mini clamp over tab and bumper lip. **See Figure 8.**
- (G) Hold bumper piece in place and start the screws in the speed clips, keeping the screws loose.
- (H) Insure that the bumper piece lip is aligned with the inside bumper lip, and is even with the top of the bumper.
- (I) Tighten the three speed clips.
- (J) Start and tighten the #10 screw in the silver mini clamp at the bottom.
- (K) Adjust the flare to match the bumper piece and tighten the last screw. **(See Step 3: C)**

Step 5: Attaching Rear Flares

- (A) Remove and save 2 screws holding mud flap to vehicle.
- (B) If vehicle has no chrome strips, insert the supplied plastic grommets into holes in wheel well lip.
- (C) Secure flare to fender using 2 screws removed in last step and the screws supplied in kit. **See Figure 5.**

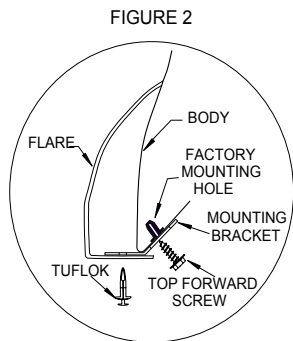

FIGURE 3

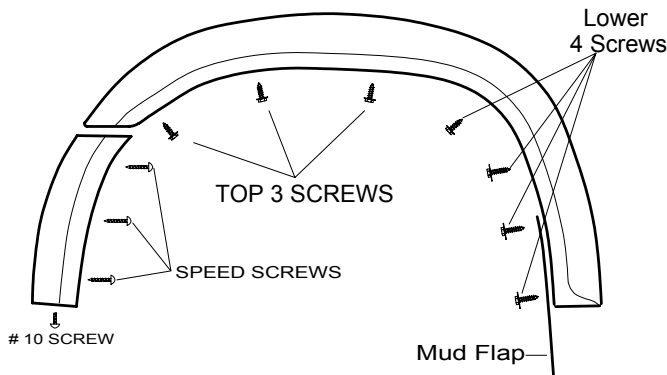

FIGURE 4

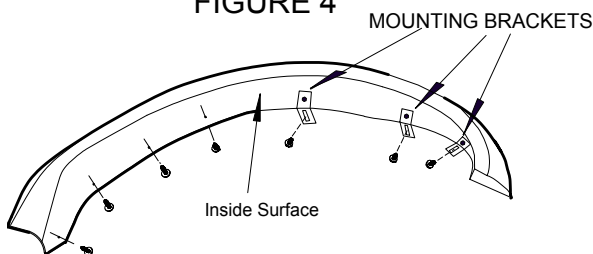

FIGURE 5

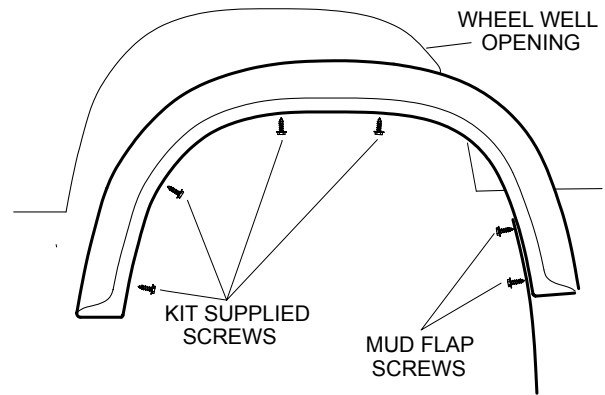

FIGURE 6

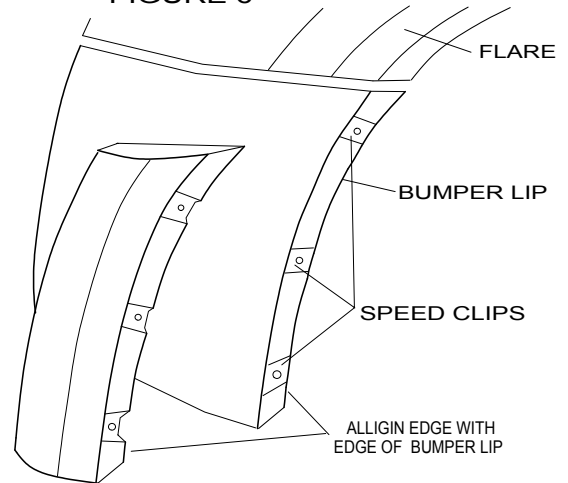

FIGURE 7

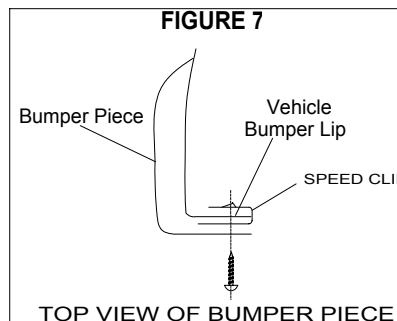

FIGURE 8

