



## PRIOR TO INSTALLATION

- A) Bushwacker®** only approves installing the flares according to these written instructions with the hardware provided.  
**WARNING:** Failure to install according to these instructions will invalidate the warranty. This includes, but is not limited to using alternative installation methods, hardware, or materials.  
**DO NOT USE:** Loctite, SuperGlue, or similar products on the hardware or the flares.
- B) Custom Paint Job:** Please test fit all the flares first to ensure you have the correct flares for your vehicle. We are not responsible for any costs you may incur if you did not confirm the flares before having it painted. We recommend hiring professionals to custom paint the products. It is also ideal to have the painting done prior to the installation to eliminate any over-spraying issues.
- C) Remove existing fender flares.** (Skip this step if you don't have existing fender flares.)  
Remove all the screws and fasteners currently holding the existing flare to the vehicle. Write down and save all the screws you have removed for re-use with the fender flares. If certain areas of the existing flares are held on with double sided tape, you will have to pry your existing flare off. Please do so carefully to avoid damage to your vehicle body.
- D) Test Fitting:** Hold each and every flare up to the fender. Make sure you align the flare to the contour of the body, and the mounting holes lineup to the existing mounting holes on the inner fender lip (if applicable). Don't worry if not all the holes line up, as some holes are meant to be used with different installation hardware that is provided. The flares may not be sitting flush at this time, our flares are designed to flex into the bodyline when you actually install them using the provided and existing hardware. At any time, do not drill or modify the fender flare in anyway, as you will void your warranty.
- E) Remove other existing parts.**  
Some vehicles may require the removal of existing parts that will interfere with the installation. Common item would be mud flaps; however by using fender flares, they act as another form of mud deflector. If you are not confident in doing so, this will be a good time to take your vehicle to a professional for the installation. Save existing screws and fasteners from the vehicle.
- F) Cleaning the vehicle.**  
Make sure to wash your vehicle, especially the area the fender flares will be mounted to including the inner fender lip. Any dirt or debris that has not been cleaned or removed can potentially cause the improper fitment of the fender flare. If you are covering existing rust, we recommend sanding down the rust and primer over to prevent further deterioration of the metal in the fender. Make sure the vehicle is dry before the installation. The fender flares come ready to be installed, however if you need to clean them, please use a mild detergent to wash and then dry completely.

# Forge™ Fender Flares Set of 4

**Set Part #28150-08**

**I-Sheet #IBAF-150**

**Rev-0 03/17/2021**

**For complete fitment info visit : [www.bushwacker.com](http://www.bushwacker.com)**

## TOOLS FOR EASY INSTALLATION:

- Utility Knife
- #2 Phillips Driver
- Socket Wrench
- Socket Set
- Grease Pencil
- Masking Tape
- Hex Key 4.0 and 4.5

**PLEASE READ:** Dirt and debris can become lodged between the fender flares and the vehicle's fenders, causing scratching and paint wear from vibration. Lund International is not responsible for any damage, and the installation of our fender flares is done with the buyer's understanding that this scratching and paint wear may occur.

## LIMITED LIFETIME WARRANTY AGAINST ANY MANUFACTURING DEFECTS

- To claim a warranty, you must provide Proof of Purchase.









## G) For Rivet Installation:

Install the rivet screws and nuts to each of the rivet holes on the flare. Our rivets are designed to screw on to the fender flares only, and they shouldn't be touching the vehicle body at all. Using hand tools, tighten nuts until fastener is snug. **DO NOT OVERTIGHTEN** as this may damage the fender flare.

- H) Installation of the Rubber Seal:** Before you start cutting any rubber seal, please study the diagram. Do not use the rubber seal in any other areas other than indicated; otherwise you will end up with a shortage of rubber seal on your last flare. Start the installation of the rubber seal as indicated in the diagram. Then cut the rubber seal with a razor. Follow the same instruction for the remaining flares.

\*Each roll of the rubber seal provided is long enough to complete the 4 fender flares and with extra to spare, however we are not responsible for the improper use of the rubber seal. Contact Bushwacker to purchase additional rolls of rubber seal.

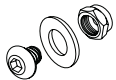
## Included in Hardware Kit:

- |   |   |   |   |  |   |
|---|---|---|---|--|---|
| 1. <br>Phillips Truss Screw<br>(SW1-0058)<br>8 pcs | 2. <br>Phillips Truss Screw<br>(SW1-0050)<br>6 pcs | 3. <br>Long U-Clip (CL1-0009)<br>2 pcs | 4. <br>S-Clip<br>(CL1-0005)<br>6 pcs | 5. <br>1" x 1.5" x 0.1"<br>Black Mylar Tab<br>(MT1-0014)<br>6 pcs | 6. <br>1" x 1.5" x 0.6"<br>Black Foam Tab<br>(MT1-0034)<br>2 pcs |
| 7. <br>Rivet + Nylon Nut<br>34 pcs                 | 8. <br>1/4" Panel Retainer<br>(RV1-P008)<br>4 pcs  | 9. <br>Rubber Seal                     |   |  |   |

## Component List:

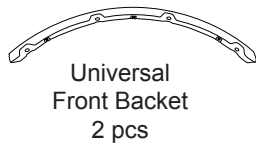
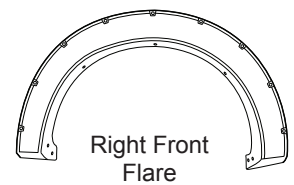
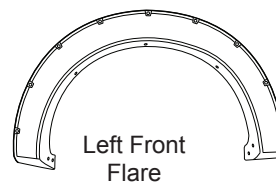
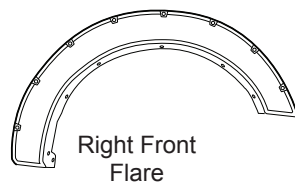
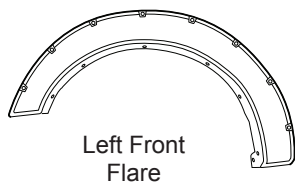

# Front Flare Installation Procedures (Driver's Side):

1. Remove seven factory screws with a socket wrench. Note that (1) location farthest to the front where screw is not to be removed. Save screws for reinstallation.
2. Hold flare to vehicle and mark one flare hole location with a grease pencil. (See Illustration below)
3. Wrap a Foam Tab (MT1-0034) around the wheel well sheet metal, centered over the mark made in Step 2.
4. Install a Clip (CL1-0009) over the Tab (MT1-0034) placed in Step 3.
5. Verify presence of U-clip on inner brackets.
6. Line up the holes in the inner bracket with the three uppermost factory holes. *NOTE: Both inner brackets are universal. (See illustration below.)*
7. Using a socket wrench, reinstall the factory screws through the inner piece.
8. Hold flare to fender, re-install three factory screws removed in Step 4 using sockets and wrench.
9. Position flare on fender, pressing inward on the flare, line up the flare mounting holes with the mounting clips on the inner piece. Install four Phillips Truss Screws (SW1-0058) through the flare and into the clips on the inner piece. Install and tighten.
10. Completed front flare installation.

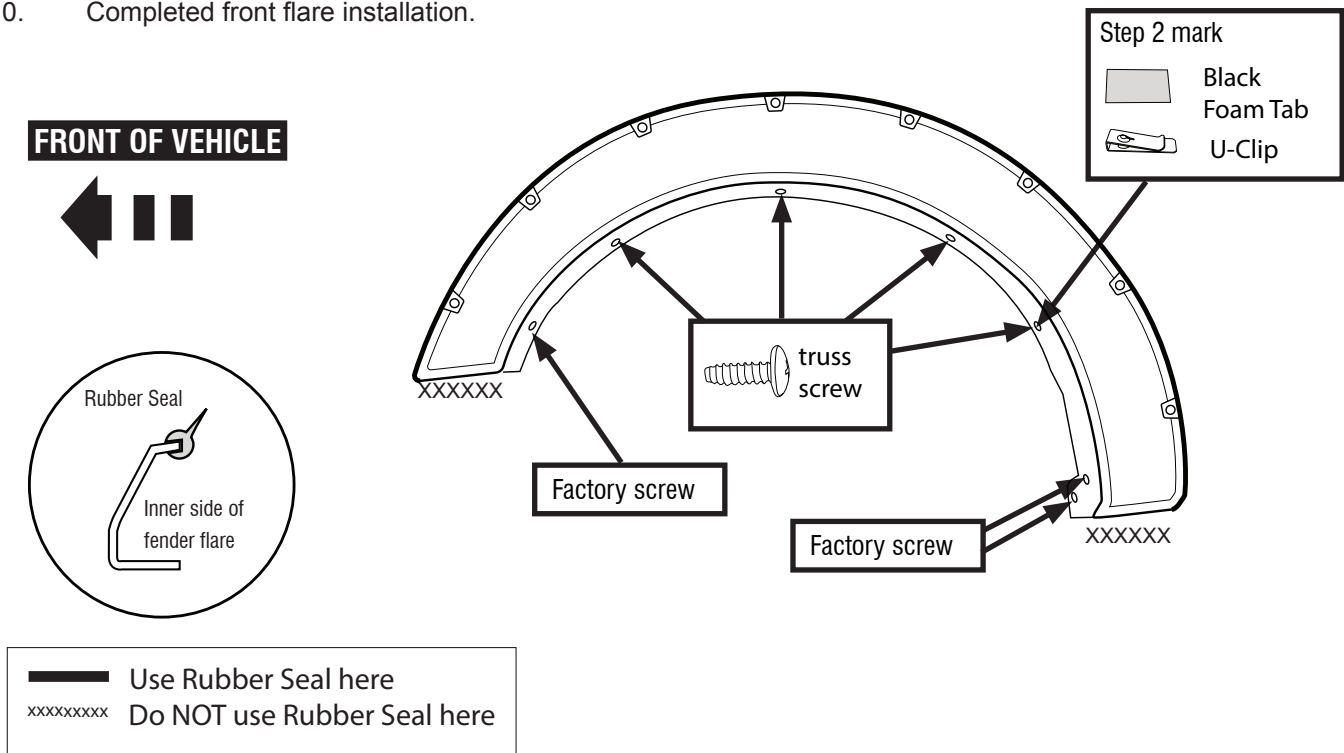

# Front Flare Bracket Installation (Driver's Side):

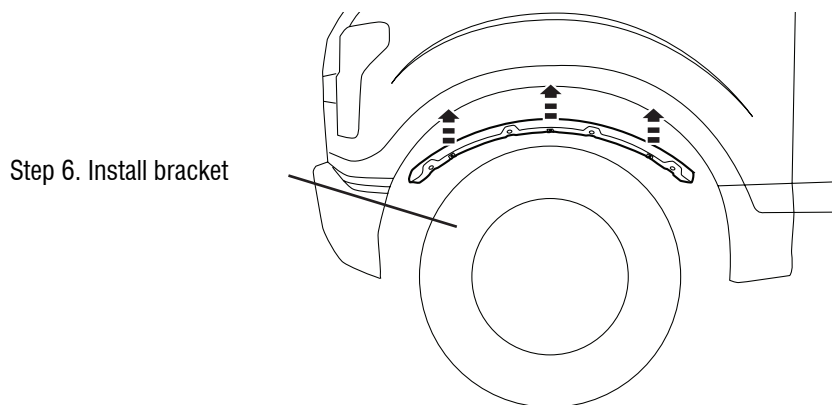

# Rear Flare Installation Procedures (Driver's Side):

11. Remove and discard factory mudflap in front of wheel well opening. Remove four factory fasteners from rear of wheel well. Retain two 7mm screws for reinstallation. Thoroughly clean the vehicle sheet metal and inner flange prior to installation.
12. Hold flare to vehicle and mark three flare hole locations with a grease pencil. (See Illustration below.)
13. Wrap a Mylar Tab (MT1-0014) around the wheel well sheet metal, centered over each of the three marks made in Step 12.
14. Install a S-Clip (CL1-0005) over each of the three Tabs (MT1-0014) placed over the upper 3 marks made in Step 13.
15. Reinstall two factory 7mm screws. Install two Panel Retainers (RV1-P008).
16. Press flares firmly onto the vehicle and install and fully tighten three screws (SW1-0050) into the clips installed in step 14.
17. Completed rear flare installation.

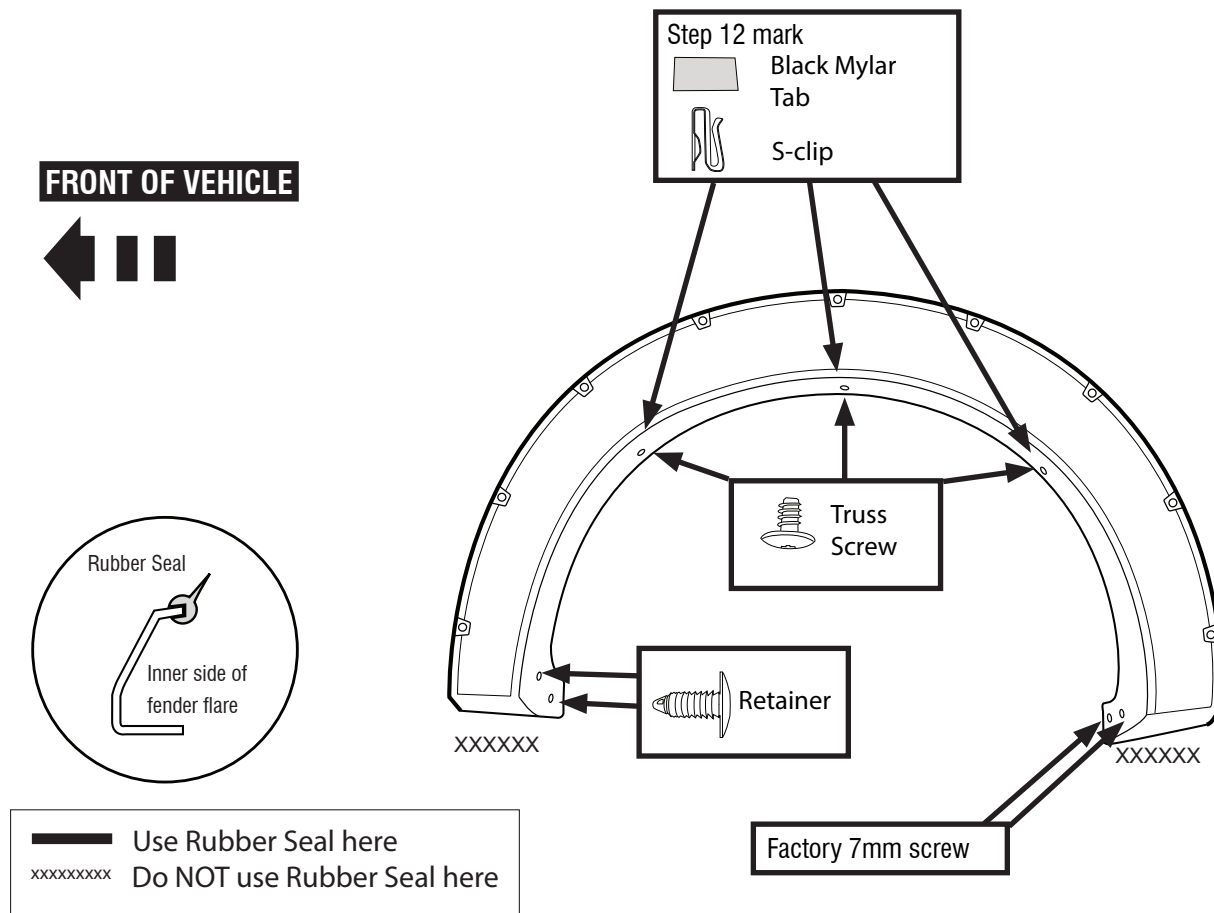

# Details

## U-Clip Installation

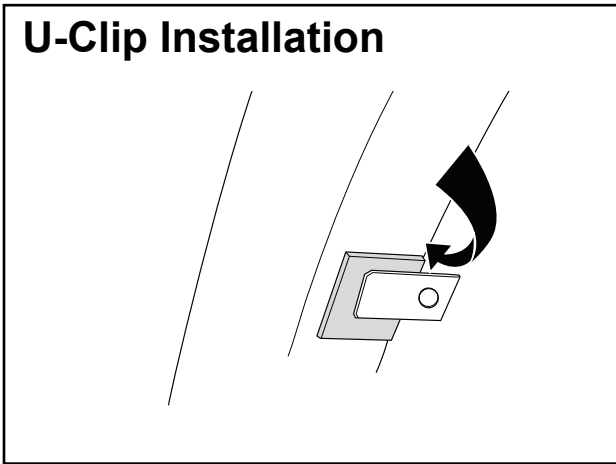

Wrap Black Foam Tab over pencil marks, then install U-Clip on top of it.

## S-Clip Installation

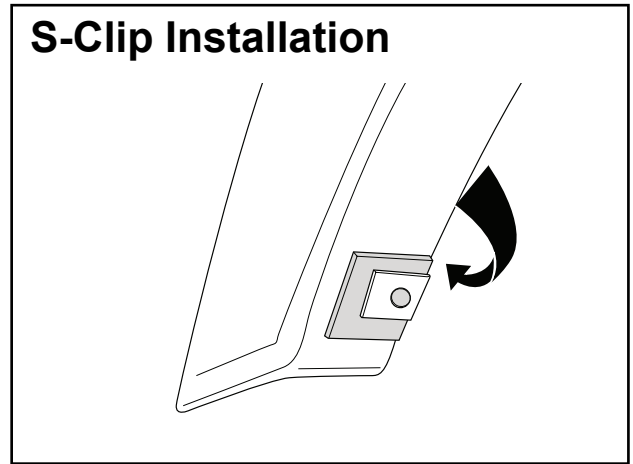

Wrap Black Mylar Tab over hole, then install S-Clip on top of it.

## Rivet Installation

