



Installation Instructions

For Part Numbers:

400-141-1	700-445 Airaid Oiled Media Filter
401-141-1	701-445 SynthaMax Dry Media Filter - Red
402-141-1	702-445 SynthaMax Dry Media Filter - Black
403-141-1	703-445 SynthaMax Dry Media Filter - Blue

2005-08 Ford F-150 4.2L V6

2004-08 Ford F-150 4.6L V8

Does Not Fit Heritage Body

Does Not Fit Vehicles Built After Jan 1, 2007

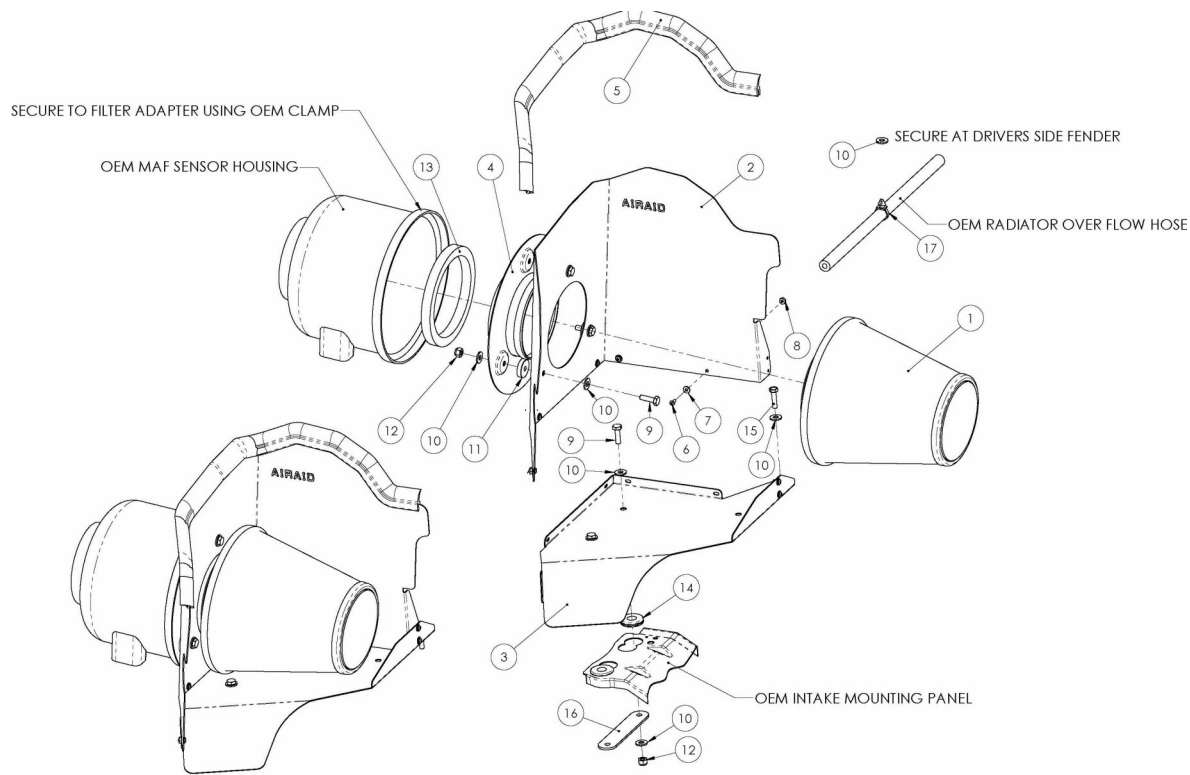

Component Identification

1.	Airaid Premium Filter	1
2.	MAF Panel	1
3.	Bottom Panel	1
4.	Filter Adapter	1
5.	Weather Strip 24 3/4"	1
6.	6 - 32 x 5/16" Screw	7
7.	#6 Flat Washer	7
8.	6-32 Keps Nut	7
9.	1/4 - 20 x 7/8" Bolt	5
10.	1/4" Flat Washer	12
11.	Bushing	3
12.	1/4 - 20 Locknut	5
13.	Gasket 4.5"	1
14.	Rubber Grommet	2
15.	M6 - 1 x 25 Hex Bolt	1
16.	Long/Narrow Bracket	1
17.	Black Plastic Hose Mount	1

Full color instructions can be viewed on our web site at Airaid.com. Use the **Product Search** function to find your part number, and click **View Details**.



1. Disconnect the negative battery cable.
Unclip the factory airbox from the factory Mass Air Flow (MAF) sensor housing.



2. Remove the factory air filter and airbox from the vehicle. Pull straight up on the airbox, to release it from the grommets, and then remove the airbox inlet from the drivers side fender.



3. Using a 5/16" socket, ratchet and extension, remove one bolt from the factory coolant reservoir mount.

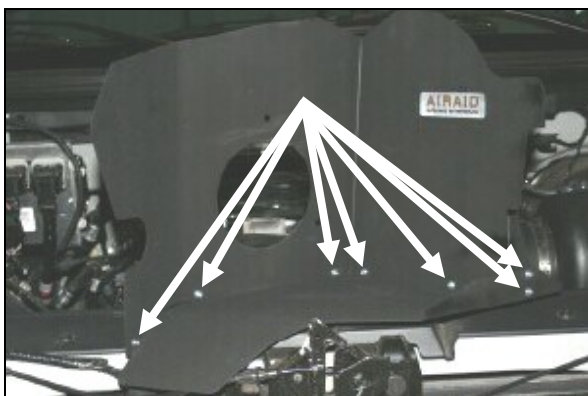

4. Assemble the Airaid Cool Air Dam (CAD) panels (#2, #3) using seven 6-32 x 5/16" screws (#6), #6 flat washers (#7), and 6-32 keps nuts (#8).



5. Insert three 1/4-20 x 7/8" bolts (#9), and 1/4" flat washers (#10) through the CAD. Place one bushing (#11) at each hole between the CAD and the filter adapter (#4). Next, secure the assembly using three 1/4" flat washers (#10), and 1/4-20 nuts (#12).



6. Install the supplied gasket (#13) onto the filter adapter.

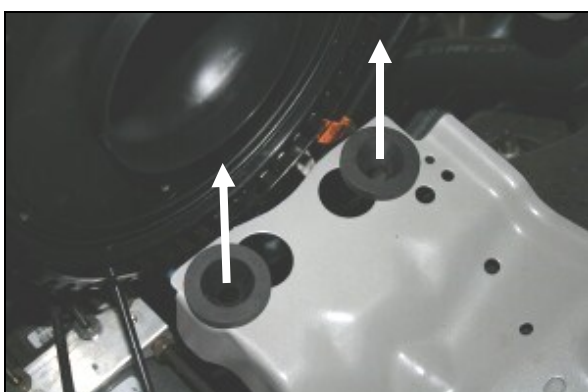

7. Remove the two factory grommets from the factory airbox mounting plate.

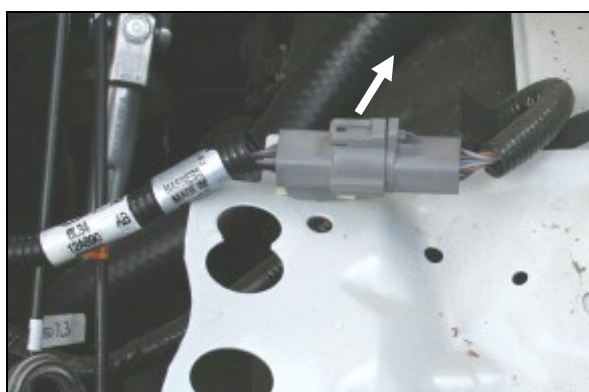

8. 4.2L Engine Only: Using a flat blade screwdriver, carefully pry the MAF sensor wiring harness connector from the holes in the airbox mounting plate (*do not disconnect it*). Move the harness towards the fire-wall to allow room for the CAD to mount.

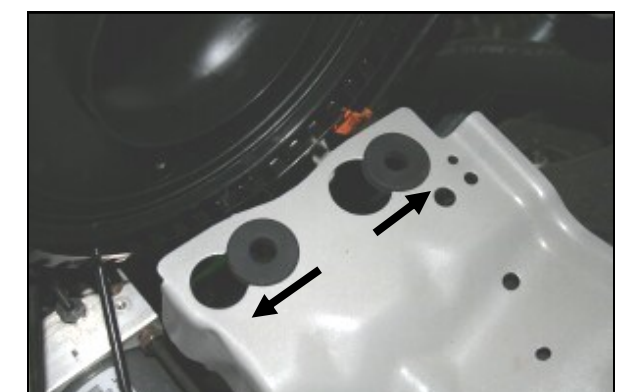

9. Slip two rubber grommets (#14) into the large holes in the factory airbox mounting plate, and then slide them sideways into the small holes as shown.



10. Install the CAD assembly into the vehicle. First, align the filter adapter with the factory MAF sensor housing, then, secure it with the factory clamp.

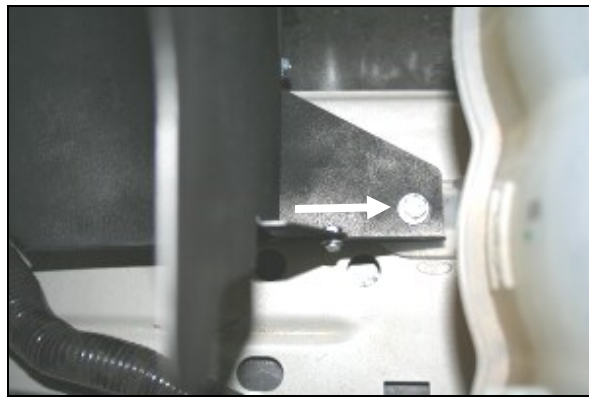

11. Align the hole in the CAD with the hole in the factory coolant reservoir mount. Insert one M6-1x25 hex bolt (#15) and 1/4" flat washer (#10) through the hole in the CAD, through the coolant reservoir mount, and into the speed nut below it.

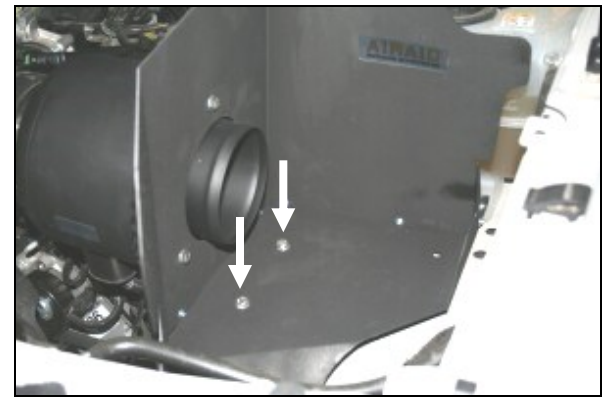

12. Insert two 1/4-20 x 7/8" bolts (#9) and 1/4" flat washers (#10) through the holes in the CAD and thru the grommets. On the underside of the factory airbox mounting plate, align the long/narrow bracket (#16), two 1/4" flat washers (#10), and two 1/4-20 nuts (#12) with the 1/4-20 x 7/8" bolts. Tighten the assembly securely.



13. Mount the Airaid Premium Filter (#1) onto the filter adapter and tighten the clamp.

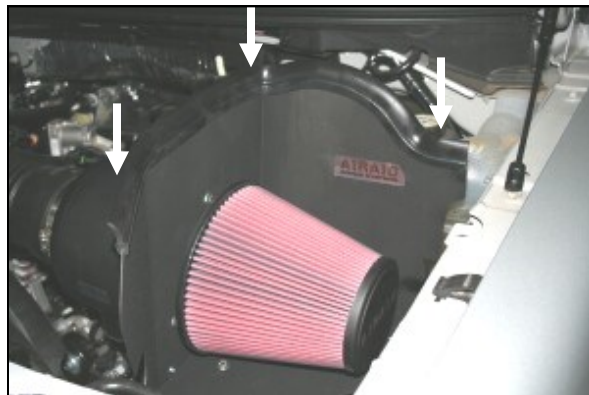

14. Install the weather strip (#5) onto the top edge of the CAD as shown. (Hint: start at one end and work your way around to the other.)



15. Slip the black plastic hose mount (#17) over the radiator overflow hose. Next, place one 1/4" flat washer (#10) over the hole on the inner drivers side fender. Slide the hose mount prongs thru the fender and thru the washer.

16. Double check your work!

Make sure there is no foreign material in the intake path. Make sure all clamps, hoses, bolts, and screws are tight.

17. Reconnect the negative battery cable!

Thank you for purchasing the Airaid Intake System. Contact Airaid @ (800) 498-6951 8:00 AM - 5:00 PM MST weekdays for questions regarding fit or instructions that are not clear to you. Your Airaid Intake System was carefully inspected and packaged. Check that no parts are missing, or were damaged during shipping. If any parts are missing, contact Airaid. The air filter element is protected from direct exposure to water and debris; care should be taken not to drive through deep water. WATER INGESTION IS THE DRIVERS RESPONSIBILITY! The air filter is reusable and should be cleaned periodically.

FILTER IDENTIFICATION

700-445 Airaid Oiled Media
702-445 Airaid SynthaMax Dry Media - Black

701-445 Airaid SynthaMax Dry Media - Red
703-445 Airaid SynthaMax Dry Media - Blue

For your Oiled media filter we suggest using the AIRAID Filter Tune-Up Kit!



P/N 790-551 Aerosol Spray
P/N 790-550 Squeeze Spray



SynthaMax

Do Not Oil

Synthamax Air Filters do not require oil. Service air filter as needed by cleaning with common non-petroleum all-purpose household cleaner and water. Simple Green®, Formula 409® or equivalent works great. Apply cleaner to outside of air filter and allow to soak. Then flush filter clean from the inside out with a garden hose and repeat steps if necessary. Do not apply high pressure water or air to clean filter. Allow filter to air dry and reinstall.