



Installation Instructions

For Part Numbers:

200-197	700-469 Airaid Oiled Media Filter
201-197	701-469 SynthaMax Dry Media Filter - Red
202-197	702-469 SynthaMax Dry Media Filter - Black
203-197	703-469 SynthaMax Dry Media Filter - Blue

2007-08 Cadillac Escalade/ESV/EXT
 2007-08 Chevrolet Avalanche
 2007-08 Chevrolet Silverado 1500/2500HD/3500HD
 2007-08 Chevrolet Tahoe/Suburban 1500/2500
 2007-08 GMC Sierra 1500/2500HD/3500HD
 2007-08 GMC Yukon/Yukon XL 1500/2500
 2007-08 GMC Denali/Denali XL
 4.3L V6, 4.8L V8, 5.3L V8, 6.0L V8, 6.2L V8
 (GMT-900 Body Style Only)

Component Identification

1.	Airaid Premium Filter	1
2.	MAF Panel	1
3.	Rear Air Dam Panel	1
4.	Airaid Intake Tube	1
5.	Air Filter Adapter	1
6.	Urethane Hump Hose	1
7.	Urethane Coupler	1
8.	3/8" x 14" Breather Hose	1
9.	Weather Strip 20 3/4"	1
10.	6-32 x 5/16" Screw	5
11.	#6 Flat Washer	5
12.	6-32 Keps Nut	5
13.	1/4 - 20 x 1/2" Button Head Bolt	3
14.	1/4" Flat Washer	7
15.	M6 - 1 x 25 Hex Bolt	4
16.	#64 Hose Clamp	4
17.	1/4" NPT x 3/8" Barb Fitting	1

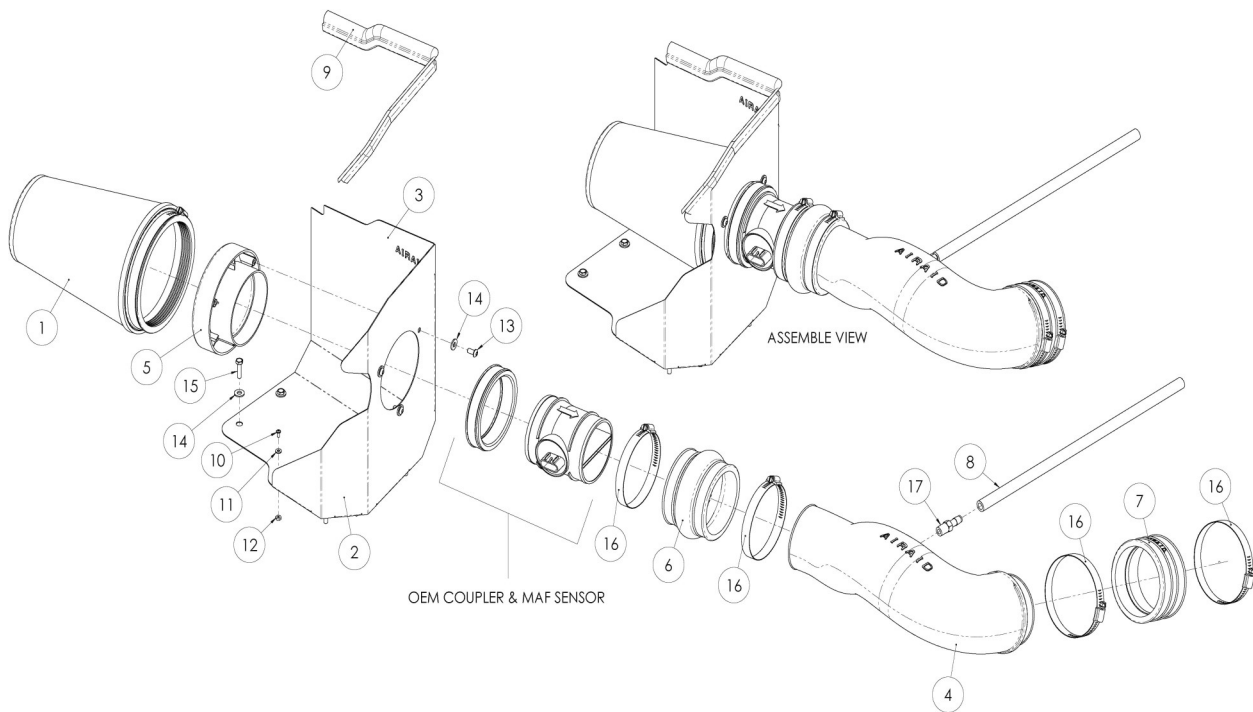

Full color instructions can be viewed on our web site at Airaid.com. Use the **Product Search** function to find your part number, and click **View Details**.



1. Disconnect the negative battery cable.
 Remove the factory beauty cover by lifting up on the front, and then pulling the cover towards the front of the vehicle. It is only held in place by grommets.



2. Disconnect the factory breather hose at the valve cover.



3. Separate the factory intake tube from the plastic clamp that secures the radiator hose to the tube. A firm downward push will usually do it.

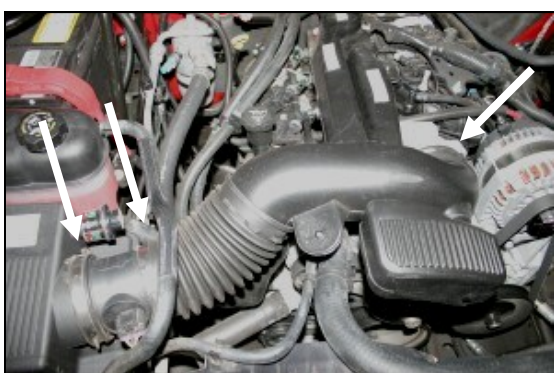

4. Loosen three hose clamps. One at each end of the factory intake tube, and one on the Mass Air Flow sensor (MAF) where it clamps to the factory airbox.



5. Slide the factory intake tube off of the MAF sensor, rotate it up so that it disengages from the mounting grommet on the intake manifold, and then slide it forward off of the throttle body and remove it from the vehicle.



6. Remove, and set aside the MAF sensor from the factory airbox using caution to retain the factory clamp and seal.



7. Rock the factory airbox back and forth to loosen it from the mounting grommets, and remove it from the vehicle.

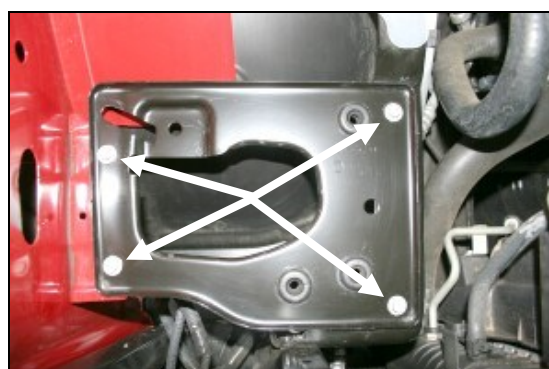

8. Using a 10mm socket, remove four bolts, and then remove the factory airbox mounting plate from the vehicle.



9. Assemble the Cool Air Dam panels (CAD) (#2 & #3) using five 6-32 x 5/16" screws (#10), #6 flat washers (#11), and 6-32 keps nuts (#12). Next install the air filter adapter (#5) into the panels as shown using three 1/4 - 20 x 1/2" button head bolts (#13), and 1/4" flat washers (#14).

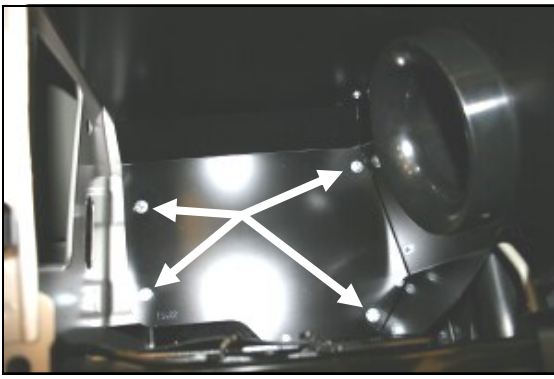

10. Install the Airaid CAD into the vehicle replacing the factory airbox. Secure the CAD using four M6 x 1.25 Hex Bolt (#15), and 1/4" flat washers (#14). Do not over tighten the four bolts.



11. Reinstall the MAF sensor onto the filter adapter, and tighten the clamp.

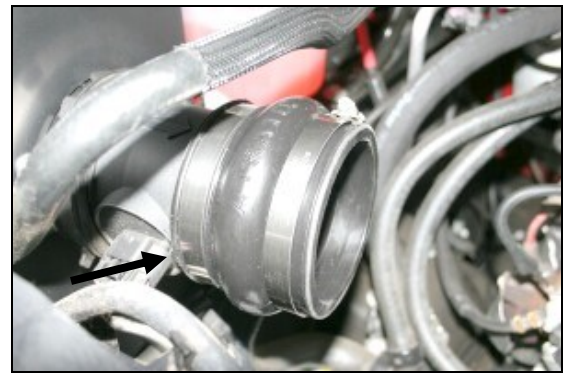

12. Install the urethane hump hose (#6), and two #64 hose clamps (#16) onto the MAF sensor as shown. Tighten only the clamp on the MAF sensor at this time.

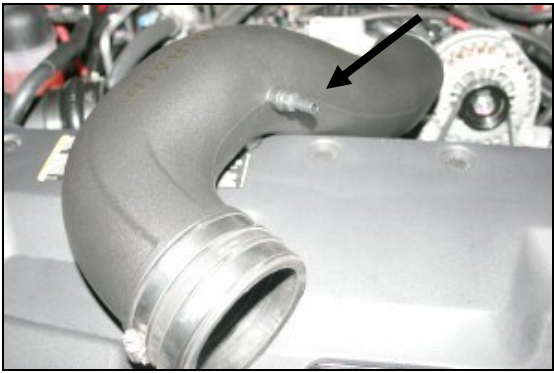

13. Install the 1/4" NPT x 3/8" Barb Fitting (#17) into the Airaid Intake Tube as shown. Next install the urethane coupler (#7) onto the throttle body end of the tube using two #64 hose clamps (#16). Tighten *only* the clamp on the tube.



14. Install the Airaid Intake Tube into the hump hose first, and then onto the throttle body. Adjust it for fit, and tighten the hose clamps. Next install the 3/8" x 14" breather hose (#8) between the 1/4" NPT x 3/8" barbed fitting in the tube, and the factory port on the valve cover.



15. Install the Airaid Premium Filter (#1) onto the air filter adapter, and tighten the hose clamp. Next install the provided weather strip (#9) onto the top of the CAD. *For ease of install, start at the inner fender, and work your way towards the radiator.* Reinstall the beauty cover.

16. Double check your work!

Make sure there is no foreign material in the intake path. Make sure all clamps, hoses, bolts, and screws are tight.

17. Reconnect the negative battery cable!

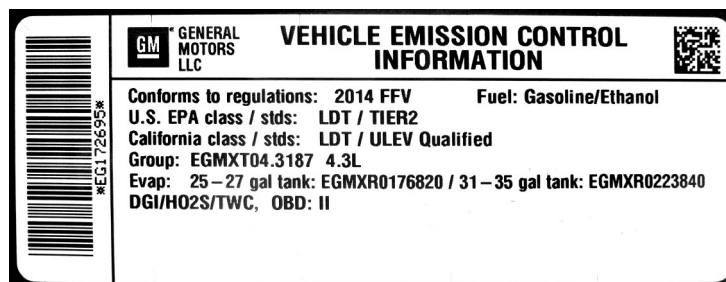

WARNING! If your vehicle has a Vehicle Emission Control Information decal affixed to the factory airbox, a new replacement label must be obtained and installed in a readily visible position in the engine compartment in order to remain CARB compliant. Failure to do so will prevent the vehicle from passing a smog check. Replacement labels can be ordered from your local dealership. Regulations state that the VEI label shall not be affixed to any equipment which is easily detached from the vehicle. Label placement, under the hood on a painted surface is recommended.

Thank you for purchasing the Airaid Intake System. Contact Airaid @ (800) 498-6951 8:00 AM - 5:00 PM MST weekdays for questions regarding fit or instructions that are not clear to you. Your Airaid Intake System was carefully inspected and packaged. Check that no parts are missing, or were damaged during shipping. If any parts are missing, contact Airaid. The air filter element is protected from direct exposure to water and debris; care should be taken not to drive through deep water. WATER INGESTION IS THE DRIVERS RESPONSIBILITY! The air filter is reusable and should be cleaned periodically.

FILTER IDENTIFICATION

700-469 Airaid Oiled Media
702-469 Airaid SynthaMax Dry Media - Black

701-469 Airaid SynthaMax Dry Media - Red
703-469 Airaid SynthaMax Dry Media - Blue

For your Oiled media filter we suggest using the AIRAID Filter Tune-Up Kit!



P/N 790-551 Aerosol Spray
P/N 790-550 Squeeze Spray



SynthaMax

Do Not Oil

Synthamax Air Filters do not require oil. Service air filter as needed by cleaning with common non-petroleum all-purpose household cleaner and water. Simple Green®, Formula 409® or equivalent works great. Apply cleaner to outside of air filter and allow to soak. Then flush filter clean from the inside out with a garden hose and repeat steps if necessary. Do not apply high pressure water or air to clean filter. Allow filter to air dry and reinstall.