

Kit #31249 2-1/2" kit without mufflers, 409 s/s kit

This kit fits '67-'81 Camaro V8, '75 Buick Apollo V8, '75-'79 Buick Skylark V8, '67-'81 Firebird V8, '62-'79 Nova/Chevy II V8, '73-'79 Omega V8, '72-'79 Phoenix & Ventura V8, all with standard headers and with 3" collectors at the headers.

Note: the catalytic converters are not supplied with this exhaust system. This system is not legal for on-road use on vehicles that originally were equipped with a catalytic converter.

Note: the headers are not included in this kit!!

Note: the mufflers are not included in this kit!! You will need 14" body length 4" x 9" oval body, 2-1/2" offset/offset (double offset).

Note: this kit is not designed for use with a rear sway bar. Modifications will be necessary to the tailpipes if so equipped.

Note: This kit uses 409 s/s, it may have a brownish color, and a magnet will stick to it.

Danger warning: should the purchaser decide to install this exhaust product at home, be warned that pleasure car or light duty truck/van "bumper" jacks are intended for emergency use only. The use of frame contact jack stands in conjunction with a floor jack as main support is highly recommended to minimize accidental dropping of a vehicle while the installation proceeds.

Note: there are differing header designs on the market. Please note that not all headers are made the same. Every effort has been made to accommodate the majority of big and small block headers for this exhaust system. Normally the headers on the passenger side come back 2-1/2" to 4" further than the driver side. Therefore the longer of the two collector pipes fits on the driver side. Often one header hangs lower than the other. The collector pipes can be swiveled to adjust for different header heights. The front extension pipes can be shortened to accommodate different muffler lengths (12" to 15" body lengths) and can be adjusted in or out from parallel to the drive shaft to accommodate different header widths. The exhaust system only uses offset/offset (double offset) mufflers.

Our newly designed system fits most common full length 3" header collector headers without modifications. On certain designs of headers, modifications, including cutting and welding, may be necessary to the front 4 exhaust pipes for fit of this system. If you are having problems with an install check out our pictures online first, otherwise give us a call. But on some headers, you will need to cut and weld for a proper fit, in this instance we would recommend installing the tail pipes first, then the mufflers, then the extension pipes, and see what modifications may be necessary for fit for your left and right collector pipes to your collectors.

Hardware kit:

- | | |
|--|---|
| 2) SST4 hangers, s/s | 1) left (driver side) collector pipe (longer) #84158671, 409 s/s |
| 2) snapper grommets # BA120 | 1) right (passenger side) collector pipe (shorter) #84158672, 409 s/s |
| 6) 5/16" x 1-1/4" lag screws s/s # 74509 | 2) left & right front extension pipes #84158673, 409 s/s |
| 2) 2-1/2" s/s clamps #MC9212SS | 1) left (driver side) tail pipe #84158675, 409 s/s |
| 2) CF300-3SS flanges, s/s | 1) right (passenger side) tail pipe #84158674, 409 s/s |
| 6) A25BF s/s accuseal clamps | |
| 6) 3/8" nuts s/s # 70712 | |
| 6) 3/8" lockwashers s/s # 71067 | |
| 6) 3/8" x 1-1/4" bolts s/s # 70107 | |
| 2) #MP48005 3" collector gaskets | |
| 2) BR92256P zinc coated rubber mount for wire hanger | |
| 2) # 2743SS 2-1/2" s/s hanger clamp with threaded rod hanger | |

Rear tail pipe hanger consists of a metal strap (SST4), snapper grommet, lag screw, and clamp (see illustration). Front tail pipe hanger consists of a BR92256P rubber mount for wire hanger, and a # 2743SS 2-1/2" hanger clamp with adjustable threaded rod hanger, and two lag screws.

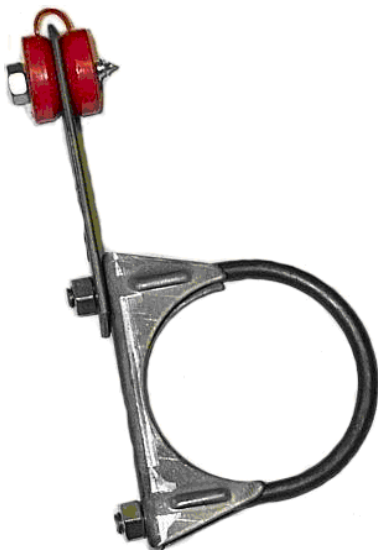

Rear tail pipe hanger assembly



Front tail pipe hanger assembly

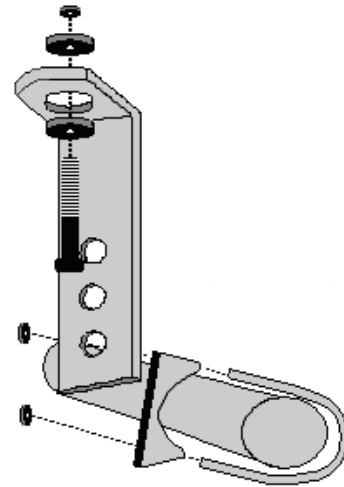
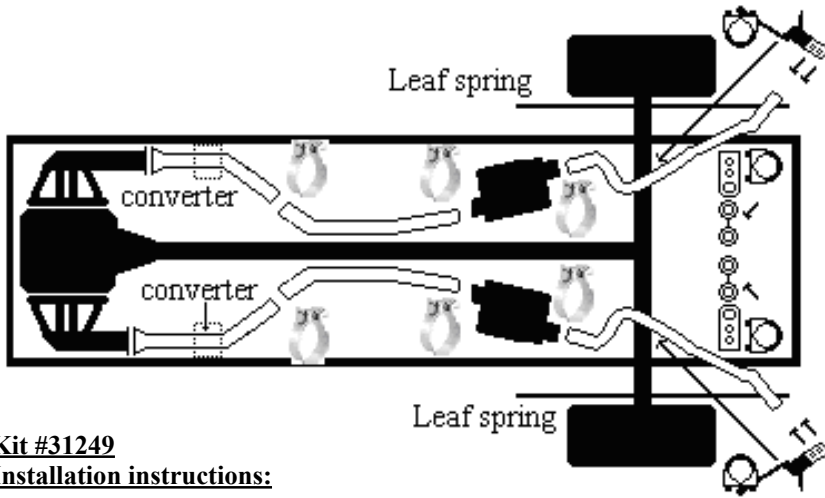

Kit #31249

Installation instructions:

Note: do not tighten any clamps or nuts until the last step!!

- 1) remove the old exhaust system after the headers. Remove the old hangers and brackets. If possible, you will want to be able to reuse the existing holes for the front tail pipe assembly.
- 2) install the left (longer) and right (shorter) collector pipes using the MP48005 gaskets and CF300-3SS flanges. Tighten only enough to hold in place, using the 3/8" x 1-1/4" bolts, nuts, and lock washers. **Note:** for vehicles requiring catalytic converters to meet EPA guidelines, catalytic converter #75016 or 75006 or equivalent should be installed on the header collector pipes after the header collectors on the collector pipes. Cutting and welding, or cutting and clamping will be necessary to install these converters. We advise that you abide by your local emissions laws on vehicles requiring converters (those that originally were equipped as such from the factory when new).
- 3) install the left and right front extension pipes to the left and right collector pipes using 2-1/2" accusal clamps. Be sure to leave adequate clearance between the floor boards and the drive shaft. **Note:** the front extension pipes may be shortened to fit various header designs or different length mufflers, you may need to trim an inch or two off the rear for fit depending on your design of headers.

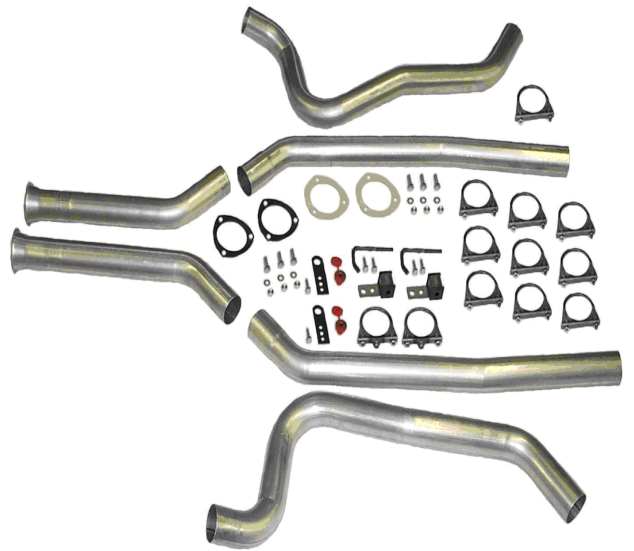
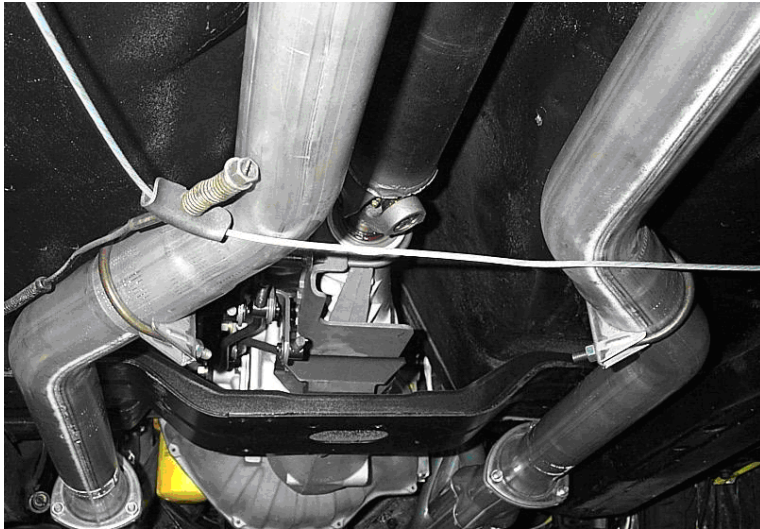

Kit #31249

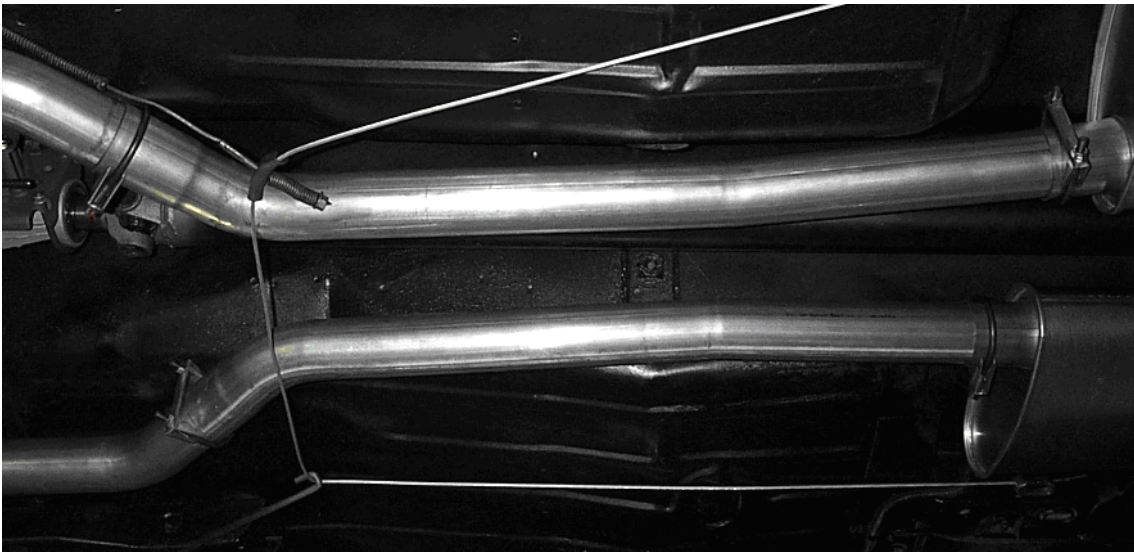

4) install the mufflers onto the front extension pipes using 2-1/2" accuseal clamps. Note: the mufflers are not included in this kit, we recommend a cross pattern slot on the inlets and outlets (like on the ID portions of the tubing in the kit) to allow the clamps to seal. You will need to use offset/offset (double offset) mufflers, 2-1/2" in/out, 4" x 9" oval body, 14" body length. Use of different length or body size, especially much thicker and wider body sizes, may create fitment issues. Rotate the front extension pipes to clear the driveshaft, and frame, and general clearance.

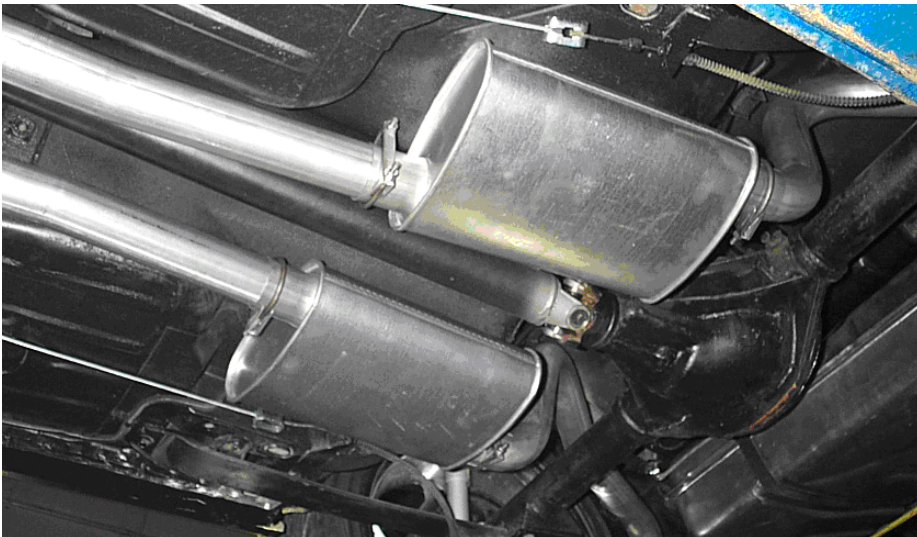

5) mount the BR92256P hanger brackets to the existing holes in the frame behind the rear axle using the o.e. 5/16" bolts. If the holes are worn or non existent, drill new 1/4" holes and install the two 5/16" x 1-1/4" lag screws per side, it is just above the second bend in the tail pipe. We would recommend installing the wire portion of the # 2743SS 2-1/2" hanger clamp with threaded rod hanger to the bracket prior to bolting into place. The hangers should be installed to the tail pipes at where the tail pipes just crosses the rear axle. The threaded rod hanger is adjustable up and down for your preferred height.

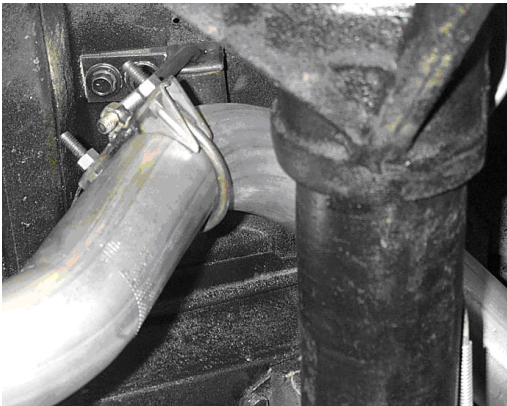

Kit #31249

6) install the left and right tail pipes to the mufflers using 2-1/2" accuseal clamps. Use the 2-1/2" clamp to connect the tail pipes to the mufflers. The inlets of the tail pipes are purposely long to accommodate differing muffler lengths, and you will need to trim these two or more inches to get proper clearance and fit. The tail pipe crosses over the top of the leaf spring and exits just behind the rear tire underneath the rear quarter panel.

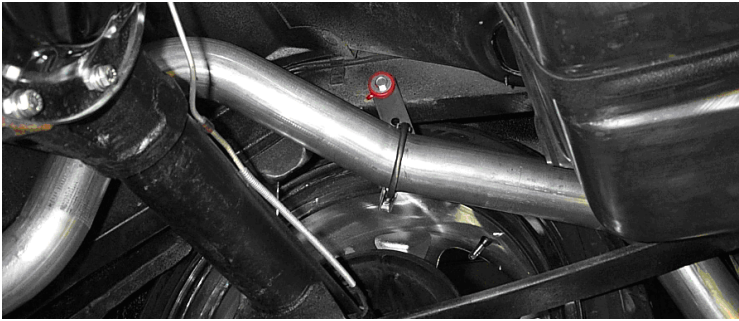

7) drill a 1/4" hole in the frame and install the SST4 hanger, grommet, and lag screw just after the rear axle where the tail pipes cross under the frame, do this for both the left and right side. Use a 2-1/2" clamp to connect the hanger to the tail pipe, it will be in about the 3rd bend from the front where the clamp will be positioned ideally, but position this as is best for your requirements and applications.

8) make sure that all the parts of the system are clear of frame members, all hoses, suspension, and brake and fuel lines. Starting at the collector pipes, tighten all connections and nuts. Make sure all parts are clear and will not leak or rattle. After several days of driving retighten all bolts.

Limitation of liability-disclaimers: the regulation of emissions production, noise levels and safety standards is undertaken by the federal government, each of the fifty state legislatures, and by many local municipalities, towns and counties.

the manufacturer makes no warranties of merchantability, of fitness for a particular purpose, or that its products are approved for general use, or that its products comply with laws, regulations or ordinances in the states where they may be sold to the ultimate purchaser, the consumer.

the entire risk as to the conformity of this product in any such state and as to repair, should the product prove to be defective or non-conforming, is on the retail purchaser, the buyer, the ultimate consumer, of such product and it is not upon the seller, distributor, or manufacturer.

in this connection, the retail purchaser, the buyer, the ultimate consumer assumes the burden of the entire cost of any and all necessary service, alterations and or repair.

the foregoing statement limits the liability of the manufacturer.

California vehicle code section 27156 prohibits the advertising, offering for sale, or installation of any device which modifies a vehicle's emission control system. This product is therefore not legal for sale or use in California on vehicles equipped with catalytic converters.

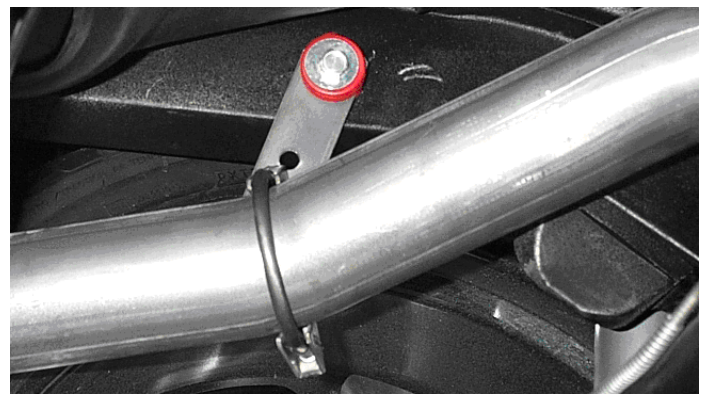
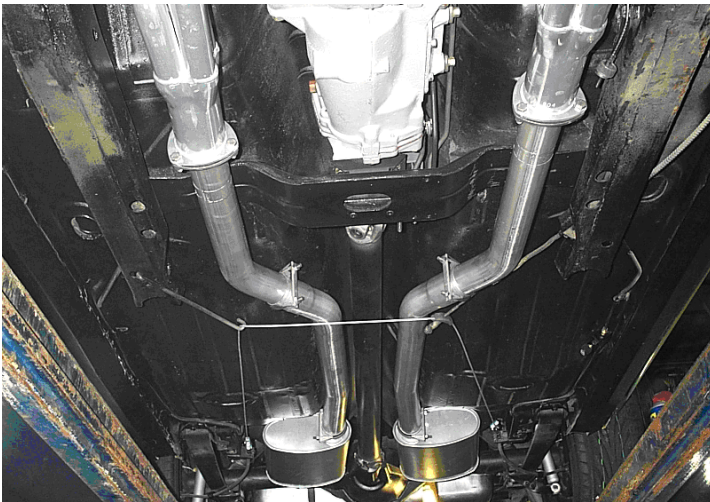

Build sheet for: 2-1/2" new design Camaro header dual kit no mufflers

Part #s: 31249, 84158670—409 s/s kit

- _____ 1) hardware kit
- _____ 1) left (driver side) collector pipe (longer) #84158671, 409 s/s
- _____ 1) right (pass. side) collector pipe (shorter) #84158672, 409 s/s
- _____ 2) slotted inlet left & right front ext. pipes #84158673, 409 s/s
- _____ 1) left (driver side) tail pipe #84158675, 409 s/s
- _____ 1) right (passenger side) tail pipe #84158674, 409 s/s

Inspected by: _____

Date: _____

Inspected by: _____

Date: _____